

7

SICUREZZA SPORT /
ABBIGLIAMENTO /
BATTELLI ALAGGIO



M T M

Fuoco di Segnalazione a Mano

Fuoco a mano a luce Rossa.

Cod.	UM	€
3020020	PZ	



Razzo di Segnalazione a Paracadute

Segnale razzo a paracadute.

Cod.	UM	€
3020024	PZ	



Boetta Fumogena

Boetta fumogena galleggiante.

Cod.	UM	€
3020007	PZ	



Segnale Due Stelle

Segnale di soccorso notturno due stelle con corpo in Plastica impermeabile. Per navi, scialuppe di salvataggio e diporto. Utile anche per sub, surf e soccorso alpino.

Cod.	UM	€
3020022	PZ	



Boetta Fumogena e Luminosa M.O.B.

Boetta fumogena e luminosa galleggiante M.O.B. (Uomo in Mare). Montata su salvagente anulare per navi e grosse imbarcazioni.

Cod.	UM	€
3020009	PZ	



Lancia Sagole Ikaros

Lancia sagole utilizzabile nelle operazioni di soccorso come cavo guida per cavi e cime. Lunghezza cavo 300 metri. Dim: 340x230 mm.

Cod.	UM	€
3020021	PZ	



Dotazione Segnali per Navi da Lavoro

Dotazione segnali per navi da lavoro.

Cod.	UM	€
3020019	CF	



7 SICUREZZA SPORT/ABBIGLIAMENTO/BATTELLI ALAGGIO

Dotazione Segnali 3NM

Dotazione segnali per la navigazione entro 3 miglia dalla costa.

Cod.	UM	€
3020013	CF	



Dotazione Segnali 12NM

Dotazione segnali per la navigazione entro 12 miglia dalla costa.

Cod.	UM	€
3020016	CF	



Dotazione Segnali 50NM

Dotazione segnali per la navigazione entro 50 miglia dalla costa.

Cod.	UM	€
3020017	CF	



Dotazione Segnali No Limits

Dotazione segnali per la navigazione senza limiti oltre 50 miglia dalla costa.

Cod.	UM	€
3020018	CF	



Dotazione Segnali 6NM (Pesca)

Dotazione segnali per la navigazione da pesca entro 6 miglia dalla costa.

Cod.	UM	€
3020026	CF	



Dotazione Segnali 20NM (Pesca)

Dotazione segnali per la navigazione da pesca entro 20 miglia dalla costa.

Cod.	UM	€
3020028	CF	



Estintori CE - R.I.Na.

Estintori a polvere certificati CE e R.I.Na. Completi di manometro che ne indica la carica e data di produzione punzonata. Vengono venduti senza cartellino di scadenza (non necessario per natanti). Per imbarcazioni il cartellino di scadenza va richiesto ad un manutentore di estintori.



Cod.	Kg	H mm	ø mm	Classe	UM	€
3020001	1	295	82	5 A-34 B-C	PZ	
3020002	2	340	120	8 A-70 B-C	PZ	



Estintori M.E.D. 96/98/EC (CO2)

Estintori a CO2 certificati M.E.D. 96/98/EC e CE 0029 - EN3. Completi di supporto e data di produzione punzonata. Vengono venduti senza cartellino di scadenza (non necessario per natanti). Per imbarcazioni il cartellino di scadenza va richiesto ad un manutentore di estintori.



Cod.	Kg	H mm	ø mm	Classe	UM	€
3020062	2	530	100	34 B	PZ	
3020065	5	712	140	89 B	PZ	



Estintori M.E.D. 96/98/EC

Estintori a polvere certificati M.E.D. 96/98/EC e CE 0029 - EN3. Completi di manometro che ne indica la carica e data di produzione punzonata. Vengono venduti senza cartellino di scadenza (non necessario per natanti). Per imbarcazioni il cartellino di scadenza va richiesto ad un manutentore di estintori.



Cod.	Kg	H mm	ø mm	Classe	UM	€
3020041	1	295	82	5 A-34 B-C	PZ	
3020042	2	340	120	13 A-89 B-C	PZ	
3020043	3	433	120	13 A-89 B-C	PZ	
3020046	6	457	185	34 A-183 B-C	PZ	



Estintori Automatici CE0029

Estintori automatici a polvere certificati CE0029. Si attivano alla temperatura di 68°<>79°. Con data di produzione punzonata. Vengono venduti senza cartellino di scadenza (non necessario per natanti). Per imbarcazioni il cartellino di scadenza va richiesto ad un manutentore di estintori.



Cod.	Kg	H mm	ø mm	Classe	UM	€
3020071	1	300	82	A-B-C	PZ	
3020073	3	340	160	A-B-C	PZ	
3020076	6	415	190	A-B-C	PZ	



Coperta Antincendio

Coperta antincendio certificata CE da tenere nei pressi di vani motore, cucine e fornelli.



Cod.	Dim mm	UM	€
3020095	1000 x 1000	PZ	



SICUREZZA SPORT/ABBIGLIAMENTO/BATTELLI ALAGGIO 7

Valigetta Pronto Soccorso Nautikit 2012

Valigetta pronto soccorso in contenitore con manico, chiusura a clip e kit di fissaggio a parete. Regolamentare per natanti fino a 10 metri e fino a 12 miglia dalla costa dove è prevista una cassetta generica.



Cod.	Dim mm	UM	€
3022006	250 x 190 x H90	CF	



Nautibag Sacca Pronto Soccorso Tabella D

Kit pronto soccorso in sacco stagno IP67.
Contenuto come da tabella D, regolamentare DM 10/03/2022 per naviglio:
- diporto senza limiti
- pesca locale <12 miglia
- pesca ravvicinata <20 miglia



Cod.	Dim mm	UM	€
3022034	280 x 280 x H600	CF	



Cassetta Pronto Soccorso Tabella D

Cassetta pronto soccorso valigetta in contenitore stagno IP67 con guarnizione ermetica, valvola automatica di pressurizzazione, manico ergonomico, chiusura di sicurezza a doppio step e doppia predisposizione lucchetto. Contenuto come da tabella D, regolamentare DM 10/03/2022 per naviglio:
- diporto senza limiti
- pesca locale <12 miglia
- pesca ravvicinata <20 miglia.



Cod.	Dim mm	UM	€
3022036	366 x 464 x H176	CF	



Cassetta Pronto Soccorso Tab. A

Cassetta pronto soccorso valigetta in contenitore stagno IP67 con guarnizione ermetica, valvola automatica di pressurizzazione, manico ergonomico, chiusura di sicurezza a doppio step e doppia predisposizione lucchetto. Contenuto come da tabella A, regolamentare DM 10/03/2022 per naviglio:
- diporto senza limiti con personale imbarcato o in attività di noleggio
- pesca ravvicinata <40 miglia
- passeggeri classe C <6 miglia - classe B <20 miglia - classe D <3 miglia.



Cod.	Dim mm	UM	€
3022040	428 x 555 x H211	CF	



Zattera di Salvataggio Rigida

Zattera di salvataggio rigida conforme al D.M. 2/12/77. Complete con nastro riflettente adesivo.

Cod.	Persone	Dim mm	Kg	UM	€
2900808	8	900 x 900 x H250	16	PZ	
2900812	12	1000 x 1000 x H300	23	PZ	

**- ZATTERE DI SALVATAGGIO ALMAR -****Zattera di Salvataggio Aperta Life Body Almar**

Zattera autogonfiabile costiera aperta per navigazione da diporto entro le 12 miglia dalla costa. Conforme DM146/2008 con revisione biennale e prima revisione dopo 3 anni. Contenitore morbido in tessuto tipo valigia.

Cod.	Persone	Dimensioni mm	Peso Kg	UM	€
2901124	4	610 x 280 x 250	27	PZ	
2901126	6	610 x 400 x 270	30	PZ	
2901128	8	610 x 400 x 270	31	PZ	
2901130	10	660 x 400 x 290	34	PZ	

**Zattera di Salvataggio ISO9650 Italia Almar**

Zattera autogonfiabile ISO9650 Italia per navigazione da diporto oltre le 12 miglia dalla costa. Conforme DM219/2002 con revisione biennale. Il contenitore può essere morbido in valigia oppure rigido in container di vetroresina.

Cod.	Persone	Dimensioni mm	Peso Kg	Contenitore	UM	€
2901346	6	700 x 480 x 290	54	Valigia	PZ	
2901356	6	770 x 510 x 350	55	Container VTR	PZ	
2901348	8	700 x 480 x 290	63	Valigia	PZ	
2901358	8	770 x 510 x 350	64	Container VTR	PZ	
2901350	10	760 x 520 x 320	70	Valigia	PZ	
2901360	10	870 x 510 x 380	72	Container VTR	PZ	
2901362	12	900 x 580 x 340	85	Container VTR	PZ	

**New****Zattera di Salvataggio International Almar**

Zattera autogonfiabile International per navigazione da diporto oltre le 12 miglia dalla costa. Il contenitore può essere morbido in valigia oppure rigido in container di vetroresina.

Cod.	Persone	Dimensioni mm	Peso Kg	Contenitore	UM	€
2901324	4	610 x 400 x 300	39	Valigia	PZ	
2901334	4	710 x 400 x 300	45	Container VTR	PZ	
2901326	6	660 x 400 x 300	54	Valigia	PZ	
2901336	6	710 x 450 x 300	55	Container VTR	PZ	
2901328	8	660 x 400 x 300	63	Valigia	PZ	
2901338	8	710 x 450 x 300	64	Container VTR	PZ	
2901330	10	700 x 400 x 300	70	Valigia	PZ	
2901340	10	710 x 530 x 320	72	Container VTR	PZ	
2901342	12	770 x 510 x 350	85	Container VTR	PZ	

**New**

Zattera di Salvataggio Compact-Dry Eurovinil

Zattera autogonfiabile costiera per navigazione da diporto entro le 12 miglia dalla costa. Il contenitore può essere morbido in valigia oppure rigido in container di Vetroresina.



Cod.	Persone	Dimensioni mm	Peso Kg	Contenitore	UM	€
2901134	4	650 x 360 x 180	22	Valigia	PZ	
2901135	4	740 x 410 x 240	25	Container VTR	PZ	
2901136	6	650 x 360 x 200	26	Valigia	PZ	
2901137	6	740 x 410 x 240	30	Container VTR	PZ	
2901138	8	650 x 360 x 210	30	Valigia	PZ	
2901139	8	740 x 410 x 270	34	Container VTR	PZ	
2901140	10	670 x 370 x 220	37	Valigia	PZ	
2901141	10	740 x 410 x 270	43	Container VTR	PZ	
2901142	12	730 x 380 x 260	41	Valigia	PZ	
2901143	12	740 x 480 x 260	46	Container VTR	PZ	



Zattera di Salvataggio Syntesy 9650 Italia Eurovinil

Zattera autogonfiabile ISO9650 Oceanic-Italia per navigazione da diporto oltre le 12 miglia dalla costa. Il contenitore può essere morbido in valigia oppure rigido in container di ABS.



Cod.	Persone	Dimensioni mm	Peso Kg	Contenitore	UM	€
2901234	4	680 x 410 x 290	39	Valigia	PZ	
2901244	4	690 x 420 x 290	42	Container ABS	PZ	
2901236	6	690 x 460 x 280	47	Valigia	PZ	
2901246	6	700 x 480 x 280	50	Container ABS	PZ	
2901238	8	760 x 490 x 280	58	Valigia	PZ	
2901248	8	790 x 480 x 300	61	Container ABS	PZ	
2901240	10	790 x 490 x 280	67	Valigia	PZ	
2901250	10	780 x 470 x 290	70	Container ABS	PZ	
2901252	12	870 x 540 x 340	79	Container ABS	PZ	



Zattera di Salvataggio Syntesy Italia 9650 Grab Bag Eurovinil

Zattera autogonfiabile ISO9650 Syntesy Italia per navigazione da diporto oltre le 12 miglia dalla costa. Provista di borsa esterna stagna con parte delle dotazioni obbligatorie che migliora gli spazi e pesi a bordo semplificando le sostituzioni. Il contenitore può essere morbido in valigia oppure rigido in container di ABS.



Cod.	Persone	Dimensioni mm	Peso Kg	Contenitore	UM	€
2901254	4	670 x 400 x 240	31 (+9)	Valigia	PZ	
2901264	4	740 x 420 x 290	36 (+9)	Container ABS	PZ	
2901256	6	680 x 410 x 260	35 (+12)	Valigia	PZ	
2901266	6	740 x 510 x 270	40 (+12)	Container ABS	PZ	
2901258	8	730 x 470 x 250	44 (+15)	Valigia	PZ	
2901268	8	740 x 520 x 290	49 (+15)	Container ABS	PZ	
2901260	10	690 x 470 x 270	50 (+18)	Valigia	PZ	
2901270	10	740 x 520 x 290	55 (+18)	Container ABS	PZ	
2901262	12	780 x 480 x 280	54 (+21)	Valigia	PZ	
2901272	12	840 x 540 x 290	60 (+21)	Container ABS	PZ	



Zattera di Salvataggio Syntesy International Eurovinil

Zattera autogonfiabile international per navigazione da diporto oltre le 12 miglia dalla costa. Il contenitore può essere morbido in valigia oppure rigido in container di Vetroresina.



Cod.	Persone	Dimensioni mm	Peso Kg	Contenitore	UM	€
2901274	4	670 x 400 x 230	25	Valigia	PZ	
2901284	4	740 x 420 x 280	28	Container VTR	PZ	
2901276	6	690 x 380 x 250	27	Valigia	PZ	
2901286	6	740 x 420 x 280	31	Container VTR	PZ	
2901278	8	690 x 400 x 250	30	Valigia	PZ	
2901288	8	740 x 510 x 290	33	Container VTR	PZ	
2901280	10	690 x 470 x 260	35	Valigia	PZ	
2901290	10	740 x 510 x 290	39	Container VTR	PZ	
2901292	12	830 x 540 x 290	52	Container VTR	PZ	



Zattera di Salvataggio Syntesy Francia-Croazia 9650 Tipo 2 Eurovinil

Zattera autogonfiabile ISO9650:2005 per navigazione da diporto costiera entro 12 miglia dalla costa. E' la zattera di più alto livello tra i prodotti certificati a normativa europea ISO. Il contenitore può essere morbido in valigia oppure rigido in container di Vetroresina.



Cod.	Persone	Dimensioni mm	Peso Kg	Contenitore	UM	€
2901170	4	670 x 400 x 240	29	Valigia	PZ	
2901171	4	740 x 420 x 290	34	Container VTR	PZ	
2901172	6	680 x 410 x 260	32	Valigia	PZ	
2901173	6	740 x 510 x 270	37	Container VTR	PZ	
2901174	8	730 x 470 x 250	40	Valigia	PZ	
2901175	8	740 x 520 x 290	45	Container VTR	PZ	
2901176	10	730 x 470 x 250	40	Valigia	PZ	
2901177	10	740 x 520 x 290	45	Container VTR	PZ	



Zattera di Salvataggio Syntesy Francia-Croazia 9650 Tipo 1>24h Eurovinil

Zattera autogonfiabile ISO9650:2005 per navigazione da diporto senza limiti oltre le 24 ore e oltre 12 miglia dalla costa. E' la zattera di più alto livello tra i prodotti certificati a normativa europea ISO. Il contenitore può essere morbido in valigia oppure rigido in container di ABS.



Cod.	Persone	Dimensioni mm	Peso Kg	Contenitore	UM	€
2901150	4	680 x 410 x 290	39	Valigia	PZ	
2901151	4	690 x 420 x 290	44	Container ABS	PZ	
2901153	6	690 x 460 x 280	47	Valigia	PZ	
2901154	6	700 x 480 x 280	52	Container ABS	PZ	
2901156	8	760 x 490 x 280	58	Valigia	PZ	
2901157	8	790 x 480 x 300	65	Container ABS	PZ	
2901159	10	790 x 490 x 280	67	Valigia	PZ	
2901160	10	780 x 470 x 290	73	Container ABS	PZ	
2901162	12	870 x 540 x 340	82	Container ABS	PZ	



- ACCESSORI PER ZATTERE DI SALVATAGGIO -

Sella Inox Regolabile per Zattere Autogonfiabili

Sella per zattere autogonfiabili con telaio regolabile in Acciaio Inox. Si adatta a vari tipi di zattere in commercio. Completa di kit fissaggio fascette a ponte.



Cod.	Dim mm	UM	€
2902004	520 x 750 x H200	PZ	



Sella Inox Regolabile per Zattere Autogonfiabili Clamp

Sella per zattere autogonfiabili con telaio regolabile in Acciaio Inox. Si adatta a vari tipi di zattere in commercio. Completa di morsetti clamp per attacco a pulpiti, passamani, rollbar, etc.



Cod.	Dim mm	UM	€
2902005	520 x 750 x H200	PZ	



Sella in Plastica per Zattere Autogonfiabili

Sella in Plastica rinforzata per zattere autogonfiabili. Completa di cinghie e fibbie a sgancio rapido.



Cod.	UM	€
4035012	CF	



7 SICUREZZA SPORT/ABBIGLIAMENTO/BATTELLI ALAGGIO

Sgancio Idrostatico Hammar

Sgancio idrostatico Hammar originale H20 R per zattere autogonfiabili.

Certificazione SOLAS e ISO9001 Bureau Veritas.

Cod.	UM	€
2902002	PZ	



Specchio da Segnalazione

Specchio che riflette i raggi solari. Può segnalare la posizione dell'imbarcazione o del naufrago M.O.B. (Man Over Board).

Cod.	UM	€
3025060	PZ	



Scandaglio Manuale

Scandaglio a mano. Utilissimo nelle emergenze.

Cod.	L m	UM	€
3025065	30	PZ	



Nastro Riflettente Adesivo

Nastro riflettente adesivo a norme Solas - omologato R.I.Na. Per zattere rigide e salvagenti anulari. Confezione: rotolo da 15 e 45 mt.

Cod.	Larghezza mm	Lunghezza m	UM	€
290091615	50	15	MT	
290091650	50	45	MT	

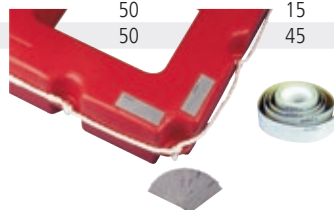

- SEGNALI DI LONTANANZA -

Riflettore Radar Tube-Base

Riflettori Radar tubolari con base per barche a motore.

Cod.	ø mm	H mm	Riflesso Radar	UM	€
3025250	50	370	1,8 Miglia	PZ	
3035210	50	570	2,5 Miglia	PZ	



Riflettore Radar Tube Uni 5NM

Riflettore Radar tubolare universale per barche a vela e a motore. Si può issare sul sartame o montare su piano con la base 3035212 opzionale. Grande capacità di riflesso Radar grazie alla maggiore superficie riflettente.

Cod.	ø mm	H mm	Riflesso Radar	UM	€
3035110	50	570	2,5 Miglia	PZ	
3035214	100	570	5 Miglia	PZ	
3035212	Base per montaggio su piano			PZ	



Riflettore Radar Cube

Riflettore Radar classico in Alluminio. Conformi ai regolamenti R.O.R.C.

Cod.	mm	UM	€
3025030	220 x 220 x 300	PZ	
3025032	290 x 290 x 400	PZ	
3025034	340 x 340 x 470	PZ	

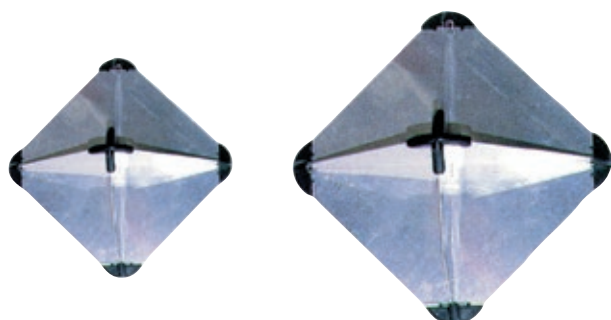

Segnali Diurni

Segnale diurno in Plastica. Smontabile e pieghevole per un facile stoccaggio.

Cod.	H mm	Forma	UM	€
3025047	470	Cono	PZ	
3025035	350	Pallone	PZ	

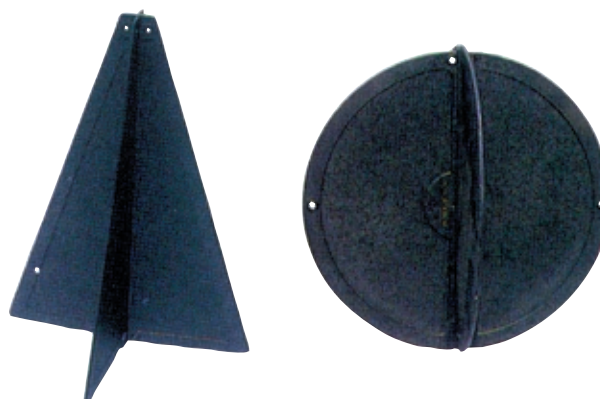

Salvagente Anulare Compatto MED 600

Salvagente anulare compatto a norme Solas 74/83 EEC 96/98. Approvato con DM385 del 29/09/99. Regolamentare per Marina Mercantile e Diporto.

Cod.	ø mm	ø1 mm	Accessori	UM	€
3008160	600	400		PZ	
3008190			Sacca	PZ	



Salvagente Anulare MED 750

Salvagente a norme Solas 74/83 EEC 96/98. Approvato con DM385 del 29/09/99. Regolamentare per Marina Mercantile e Diporto.

Cod.	ø mm	ø1 mm	UM	€
3008075	750	440	PZ	



Sacca Salvagente Anulare

Sacca per salvagenti anulari in tessuto di poliesteri imbottito con strato interno di PVC, cinghie di fissaggio regolabili e apertura a cerniera. Può contenere un salvagente anulare da 600 mm con boetta e sagola.

Cod.	ø mm	Colore	UM	€
3008190	680	BIANCO	PZ	
3008188	680	GRIGIO	PZ	
3008192	680	BLU NAVY	PZ	



Salvagente Ferro di Cavallo Approvato

Salvagente a ferro di cavallo Albatross A.03 approvato DM385 del 29/09/99. Nautica da Diporto tipo conforme al DM367 del 07/06/04.

Cod.	H mm	W mm	UM	€
3009028	540	590	PZ	



Salvagente Anulare Blue & Red

Salvagente anulare (non omologato) in Polistirolo rivestito in tessuto PVC.

Cod.	ø mm	ø1 mm	Nastro	UM	€
3008060	600	350	ROSSO	PZ	
3008061	600	350	BLUE	PZ	



Salvagente Ferro di Cavallo

Salvagente a ferro di cavallo in espanso a cellula chiusa con copertura levabile a cerniera. Non omologato.

Cod.	Colore	UM	€
3009002	GIALLO	PZ	
3009004	ROSSO	PZ	
3009006	BIANCO	PZ	



Salvagente Ferro di Cavallo Completo

Salvagente a ferro di cavallo con copertura levabile a cerniera. Completo di supporto in Acciaio Inossidabile e boetta MED. Non omologato.

Cod.	Colore	UM	€
3009012	GIALLO	PZ	
3009014	ROSSO	PZ	
3009016	BIANCO	PZ	



Salvagente Ferro di Cavallo Completo con Sacca

Salvagente a ferro di cavallo con copertura levabile a cerniera. Completo di supporto in Acciaio Inossidabile, boetta MED e sacca impermeabile di protezione con sistema di attacco. Non omologato.

Cod.	UM	€
3009020	PZ	



Sacca per Salvagente Ferro di Cavallo

Sacca impermeabile per salvagenti a ferro di cavallo. Dotata di sistema di attacco e apertura a cerniera.

Cod.	UM	€
3009019	PZ	



Supporto per Salvagente Inox Std

Supporto in Acciaio Inossidabile per salvagente anulare.

Attacco a parete e a tubo da $\varnothing 22 \times 25$ mm.

Cod.	UM	€
3009090	PZ	



Supporto per Salvagente Soft Std

Supporto in PVC con cinghia di sicurezza per salvagente anulare.

Attacco a parete e a tubo da $\varnothing 22 \times 25$ mm.

Cod.	UM	€
3009089	PZ	



Supporto per Salvagente Inox Hi

Supporto in Acciaio Inossidabile per salvagente anulare con clips per boetta.

Con attacco a parete e a tubo da $\varnothing 22 \times 25$ mm.

Cod.	UM	€
3009091	PZ	



Supporto per Salvagente Inox LG

Supporto in Acciaio Inossidabile per salvagente a ferro di cavallo con clips per boetta.

Attacco a parete e a tubo da $\varnothing 22 \times 25$ mm.

Cod.	UM	€
3008090	PZ	

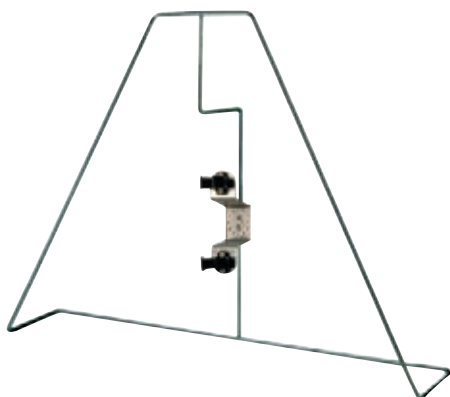

Supporto per Salvagente Inox Ring

Supporto in Acciaio Inossidabile per salvagente anulare con clips per boetta.

Attacco a parete e a tubo da $\varnothing 22 \times 25$ mm.

Cod.	Per anulare \varnothing mm	UM	€
3008096	650	PZ	
3008097	750	PZ	



Contenitore per Sagole Salvagente

Contenitore a cesta per sagole di salvataggio in filo di Acciaio Inox.

Attacco a parete e a tubo $\varnothing 22 \times 25$ mm.

Cod.	UM	€
3009097	PZ	



Sagola per Salvagente Reg 1

Sagola galleggiante per salvagenti regolamentare per navigazione da diporto.

Dia. 8 mm x Lunghezza 30 m - Tenuta: 400 Kg.

Cod.	UM	€
3009093	PZ	



Sagola per Salvagente Reg 2 Sacco

Sagola galleggiante per salvagenti regolamentare per navigazione da diporto.

Dia. 8 mm x lunghezza 30 m - Tenuta: 400 Kg.

Confezione da lancio in sacca impermeabile con maniglie.

Cod.	UM	€
3009094	PZ	



Sagola per Salvagente Reg 3 Throw

Kit lancia sagola in custodia rigida per salvagenti anulari con diametro interno da 45 cm.

Conforme Solas e DM385 29/09/99 per navigazione mercantile e da diporto. Sagola $\varnothing 8$ mm x Lunghezza 30 m - Tenuta: 400 Kg.

Cod.	UM	€
3009095	PZ	



Contenitore per Salvagente Cover

Contenitore chiuso con coperchio per salvagenti anulari e sagola. Può essere fissato sul supporto per creare un presidio di salvataggio. Base supporto 300 x 300 mm con fori M12.



Cod.	Ref	Accessori	UM	€
3008194	Contenitore		PZ	
3008198		Supporto 5 x 10 x H200 cm	PZ	



Contenitore per Salvagente Open

Contenitore aperto per salvagenti anulari e sagola. Può essere fissato sul supporto per creare un presidio di salvataggio. Base supporto 300 x 300 mm con fori M12.



Cod.	Ref	Accessori	UM	€
3008193	Contenitore		PZ	
3008197		Supporto 4 x 6 x H150 cm	PZ	
3008198		Supporto 5 x 10 x H200 cm	PZ	



Boetta Luminosa Solas/MED Sirius

Boetta luminosa con attivazione salina (si accende solo a contatto con l'acqua). Circuito e pile protetti in schiuma poliuretanicca. Pile al Litio incluse con durata di 5 anni. A norme Solas e direttiva comunitaria M.E.D. 96/98/CE. Regolamentare Marina Mercantile e Diporto.



Cod.	UM	€
3020006	PZ	



Boetta Luminosa Solas/MED Vega

Boetta luminosa galleggiante in materiale antiurto. Utilizza 4 pile alcaline D da 1,5 V. A norme Solas e direttiva comunitaria M.E.D. 96/98/CE. Regolamentare Marina Mercantile e Diporto.



Cod.	UM	€
3020005	PZ	



Supporto Boetta

Supporto clips per boetta con attacco orientabile in Acciaio Inox a parete e a tubo da ø 22<>25mm.



Cod.	UM	€
3008093	PZ	



Boetta Luminosa Solas/MED KTR LED

Boetta luminosa elettronica impermeabile di minime dimensioni per salvagenti anulari. Dotata di circuito elettronico SMD con attivazione a capovolgimento e LED ad alta potenza. Utilizza 4 pile alcaline stilo tipo LR6 incluse. A norme Solas e direttiva comunitaria M.E.D. 96/98/CE. Regolamentare Marina Mercantile e Diporto.



Cod.	H mm	ø mm	UM	€
3020011	130	115	PZ	



- ACCESSORI PER CINTURE DI SALVATAGGIO -

Luce per Salvagente SOLAS/MED Lampo

Luce elettronica lampeggiante per giubbotti salvagente. Utilizza 4 batterie Alkaline AA da 1,5V dalla durata di 5 anni. A norme Solas e direttiva comunitaria M.E.D. 96/98/CE. Regolamentare Marina Mercantile e Diporto.



Cod.	UM	€
3020004	PZ	



Luce per Salvagente SOLAS/MED Conqueror LED

Luce elettronica lampeggiante LED compatta per giubbotti salvagente. Batteria al Litio con 5 anni di durata, durata operativa oltre 8 ore, attivazione salina. Corpo resistente all'acqua, alla corrosione e al fuoco. A norme Solas/USCG e direttiva comunitaria MED 96/98/CE. Regolamentare Marina Mercantile e Diporto.



Cod.	Dim mm	UM	€
3020031	70 x 38 x 37	PZ	



Fischio di Segnalazione

Fischio di segnalazione regolamentare CE piatto per giubbotti e cinture salvagente.



Cod.	UM	€
3021002	PZ	



Nastro Riflettente per Salvagente

Nastro riflettente omologato R.I.Na. a norme Solas. Da cucire su giubbetti di salvataggio. Confezione: rotolo da 15 e 45 mt.



Cod.	Larghezza mm	L m	UM	€
290091715	50	15	MT	
290091750	50	45	MT	



Sistema di Recupero M.O.B. Safeling

Sistema di recupero Safeling M.O.B. (Man Over Board - Uomo a Mare). Cintura galleggiante e 40 m di sagola conforme Dir. Europea 89/686 EEC. Contenitore con fibbie di fissaggio alla barca.



Cod.	UM	€
3015059	PZ	

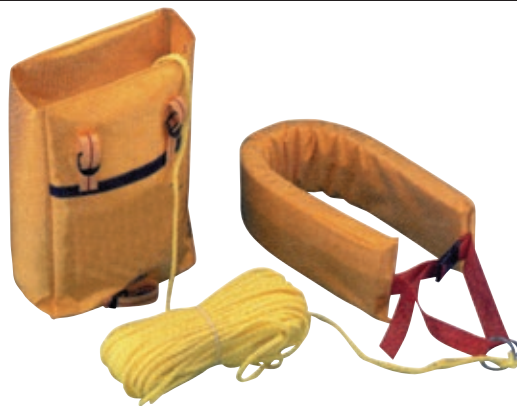
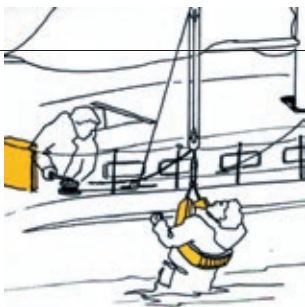

Bansigo Avvolgente

Bansigo avvolgente in resistente tessuto di Poliestere con nastri e ganci collaudati 300 Kg e tasca porta attrezzi.



Cod.	UM	€
3010092	PZ	



Bansigo Sailing

Bansigo da albero in resistente tessuto di Nylon imbottito di espanso per una maggiore libertà nei movimenti. Con fibbie di regolazione, cinghie di sollevamento e tasche porta attrezzi.



Cod.	Dimensioni cm	UM	€
3010093	45 x 45	PZ	



Baywatch Lifeguard

Galleggiante tipo Baywatch con 2 metri di cima e tracolla.

Cod.	L cm	Kg	UM	€
3023020	68	1,2	PZ	

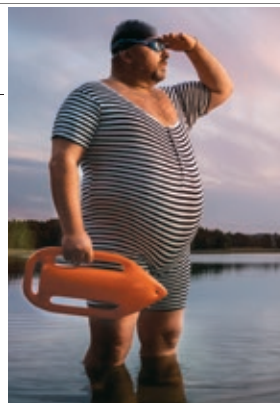

Cintura di Salvataggio Pet

Cinture di salvataggio regolamentari per cani a gatti di qualità eccezionale. Facilmente regolabili sono complete di maniglie per il sollevamento.



Cod.	Taglia	Kg	UM	€
3014000	S small	<10	PZ	
3014001	M medium	10<->25	PZ	
3014002	L large	25<->40	PZ	
3014003	XL extra large	25<->60	PZ	



7 SICUREZZA SPORT/ABBIGLIAMENTO/BATTELLI ALAGGIO

Cintura di Sicurezza VSG

Cintura di sicurezza regolabile in cinghia di Poliestere ad alta resistenza e ferramenta in Acciaio Inox. Certificata CE-ISO12401.



Cod.	Taglia	Kg	UM	€
3015052	S	<50	PZ	
3015062	L	50>	PZ	



Cintura di Sicurezza Speedy

Cintura di sicurezza in cinghia di Poliestere alta resistenza con ferramenta in Acciaio Inox. Spallacci fissi e regolazione in vita. Completa di cinghia di aggancio con moschettoni in Acciaio Inox.



Cod.	Taglia	Kg	UM	€
3015160	L	50>	PZ	



Cinghie di Sicurezza VS 2M

Cinghie di sicurezza in Poliestere per cinture di sicurezza con moschettoni autobloccanti in Acciaio Inox. Certificate CE-ISO12401.

La cinghia Cod.3015058 ha un moschettoni e una gassa.

La cinghia Cod.3015061 ha due moschettoni.

La cinghia Cod.3015063 con due moschettoni è estensibile da 1 a 2m.



Cod.	L cm	Moschettoni	UM	€
3015058	200	1	PZ	
3015061	200	2	PZ	
3015063	100<->200	2	PZ	



Cinghia di Sicurezza 2M Extend

Cinghia di sicurezza estensibili in Poliestere per cinture di sicurezza con moschettoni autobloccanti in Acciaio Inox AISI316. Omologazione CE ISO12401.



Cod.	L cm	Moschettoni	UM	€
3015064	100<->200	2	PZ	
3015066	100<->200<->100	3	PZ	

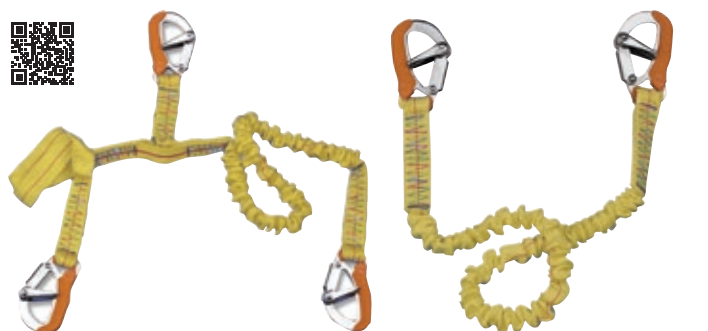

Cinghie di Sicurezza Offshore

Cinghie ombelicali per imbraghi di sicurezza in Poliestere H.T. Molto leggere e maneggevoli grazie ai moschettoni autobloccanti in lega di Alluminio. Certificate CE-ISO12401.



Cod.	L cm	Moschettoni	UM	€
3015065	200	2	PZ	
3015067	140<->200	3	PZ	



Cinghia di Sicurezza Wichard Lyf'Safe

Coppia di cinghie di sicurezza regolabili che permettono di muoversi in sicurezza sul ponte. Progettate per tenere due persone da 100 Kg appese fuori bordo, anche con mare mosso. Molto resistenti, costruite con striscia catarifrangente e bordo antiabrasione su entrambi i lati. Si fissano facilmente su qualsiasi bitta, golfare o punto di legatura grazie alla gassa e alla fibbia anti slittamento completa di cassa fotoluminescente. Larghezza cinghie 25 mm. Carico di rottura nominale 3000 Kg.



Cod.	L m	UM	€
3015072	2 x 11	CP	
3015073	2 x 14	CP	
3015074	2 x 16	CP	



Cintura di Salvataggio 100N

Cintura di salvataggio compatta da 100N completa di cinghia con fibbia, nastri riflettenti e fischietto. Certificata EN ISO 12402-4 per navigazione da diporto entro 6 miglia dalla costa. 100N - Per l'uso in acque costiere, adatto anche a persone che non sanno nuotare, ma con abbigliamento leggero. Non adatto a persone senza conoscenza.



Cod.	Taglia	Kg x Persona	UM	€
3010101	S	15<>40	PZ	
3010102	L	40>	PZ	



Cintura di Salvataggio 150N

Cintura di salvataggio compatta da 150N completa di cinghia con fibbia, nastri riflettenti e fischietto. Certificata EN ISO 12402-3 per navigazione da diporto oltre 6 miglia dalla costa. 150N - Per l'uso in mare aperto, anche per persone senza conoscenza.



Cod.	Taglia	Kg x persona	UM	€
3010201	S	20<50	PZ	
3010202	L	50>70>	PZ	



Cintura Solas MED 170N

Cintura di salvataggio approvata Solas M.E.D. 2014/90/EU, costruita secondo le ultime normative in vigore per il trasporto passeggeri ed il trasporto merci. Completa di cinghia con fibbia, maniglia di recupero, buddy line, nastri riflettenti e fischietto. 170N - Per l'uso in acque agitate, per persone (anche senza conoscenza) anche molto vestite e con cerate impermeabili.



Cod.	Taglia	Kg x persona	UM	€
3010014	Infante	<15	PZ	
3010015	Ragazzino	<43	PZ	
3010024	Adulto	43>	PZ	



- BORSE CON DOTAZIONI DI SICUREZZA -

Borsa Dotazioni Sicurezza

Borsa con dotazioni di sicurezza per 4 o 6 persone entro le 6 o 12 miglia dalla costa. Comprende: 4 o 6 cinture di salvataggio da 100N o 150N / 1 ancora da 2,5 o 4,0 Kg / 1 cima ancora 30 mt / 1 cima salvagente 30 mt / 1 bandiera / 1 gancio d'accosto / 1 sessoria / 1 estintore / 1 avvisatore acustico. I segnali di soccorso 3020016 vanno ordinati a parte.



Cod.	Persone	Borsa con dotazioni	Cinture salvagente	Ancora Kg	UM	€
3030611	4	Entro 6 miglia	4 x 100N	2,5	CF	
3030612	4	Entro 12 miglia	4 x 150N	4,0	CF	
3030613	6	Entro 6 miglia	6 x 100N	2,5	CF	



Borse Dotazioni

Borse per dotazioni di sicurezza (vuote).



Cod.	Dim cm	Misura	UM	€
3030621	60 x 40 x 35	S per dotazioni 4 persone (100N)	PZ	
3030622	65 x 50 x 40	M per dotazioni 4 persone (150N)	PZ	
3030623	70 x 40 x 50	L per dotazioni 6 persone (100N)	PZ	
3030624	55 x 50 x 35	XL per dotazioni 6 persone (150N)	PZ	



Giubbotto Salvagente Bravo 100

Giubbotto salvagente EN ISO 12402-4 da 100N molto comodo e vestibile. Approvato per navigazione da diporto entro le 6 miglia dalla costa. Tessuto antistrappo, imbottitura morbida, nastri riflettenti e fischietto. Chiusura a cerniera, cinghia con fibbia e cinghie sottogamba. 100N - Per l'uso in acque costiere, adatto anche a persone che non sanno nuotare.

Cod.	Taglia	Kg x persona	UM	€
3013111	Baby	<15	PZ	
3013112	XS	<20	PZ	
3013113	S	20<30	PZ	
3013114	M	30<40	PZ	
3013115	M	40<50	PZ	
3013117	L	50<70	PZ	
3013118	XL	70<80	PZ	
3013119	XXL	80<120	PZ	



Giubbotto Salvagente Martinica 150

Giubbotto salvagente EN ISO 12402-3 da 150N comodo e vestibile. Approvato per navigazione da diporto d'altura oltre le 6 miglia dalla costa. Tessuto antistrappo, chiusura a cerniera, 2 cinghie con fibbia, cinghie sottogamba, maniglia di recupero, nastri riflettenti e fischietto. 150N - Per l'uso in mare aperto, anche per persone senza conoscenza.

Cod.	Taglia	Kg x persona	UM	€
3013201	XXS	15<>30	PZ	
3013203	XS	30<>40	PZ	
3013205	S	40<>50	PZ	
3013207	M	50<>70	PZ	
3013208	L	70<>80	PZ	
3013209	XL	80<>90	PZ	
3013210	XXL	90>	PZ	



Giubbotto Salvagente Bravo Baby 100

Giubbotto salvagente per bimbi EN ISO 12402-4 da 100N comodo e vestibile. Approvato per navigazione da diporto entro le 6 miglia dalla costa. Tessuto antistrappo con disegni, imbottitura morbida, nastri riflettenti e fischietto. Chiusura a cerniera, cinghia con fibbia e cinghie sottogamba. 100N - Per l'uso in acque costiere, adatto anche a persone che non sanno nuotare, ma con abbigliamento leggero. Non adatto a persone senza conoscenza.

Cod.	Taglia	Kg x persona	UM	€
3013510	S baby	5<10	PZ	
3013511	M baby	10<15	PZ	
3013512	L baby	15<20	PZ	



Giubbotto Salvagente Kid 100

Giubbotto salvagente EN ISO 12402-4 da 100N molto comodo e vestibile. Approvato per navigazione da diporto entro le 6 miglia dalla costa. Collo disegnato per una migliore protezione della testa, imbottitura morbida, nastri riflettenti e fischietto. Chiusura a cerniera, cinghia con fibbia e cinghie sottogamba. 100N - Adatto a persone che sanno nuotare. Non adatto a persone senza conoscenza.

Cod.	Taglia	Kg x persona	UM	€
3013140	Bimbo	15<>30	PZ	
3013141	Ragazzino	30<>40	PZ	



Giubbotto Salvagente Baby Safe 150

Giubbotto salvagente EN ISO 12402-3 da 150N per neonati. Approvato per navigazione da diporto d'altura oltre le 6 miglia dalla costa. Masse galleggianti studiate per garantire un'ottimale posizione in acqua di neonati e bambini. Chiusura con cerniera e fascia addominale regolabile, maniglia di recupero, nastri riflettenti e fischietto. 150N - Per l'uso in mare aperto, anche per persone senza conoscenza.

Cod.	Taglia	Kg x persona	UM	€
3013145	Neonato	<15	PZ	



Cintura Autogonfiabile Guardian 150N

Cintura autogonfiabile da 150N approvata CE ISO12402-3 per diporto senza limiti. Custodia di protezione esterna in tessuto altamente resistente, nastri retroriflettenti, fischietto, tubo per gonfiaggio orale, maniglia di sollevamento e chiusura con fibbia regolabile a sgancio rapido. Camera di gonfiaggio interna con attivazione automatica UML MK5 33g e tiretto manuale. Taglia unica per adulti.



Cod.	Colore	Ricambi	UM	€
3013904	ROSSO		PZ	
3013817		Ricarica automatica UML MK5 33g	PZ	



Cintura Autogonfiabile Spinnaker 180N

Cintura autogonfiabile da 180N approvata CE ISO12402-3 per diporto senza limiti. Completa di imbrago certificato CE ISO12401 con attacco per nastro di sicurezza e doppio sottogamba. Custodia in tessuto tecnico 420D ad alta resistenza, chiusura con fibbia regolabile a sgancio rapido e zip burst laterali ad apertura rapida, tasca porta accessori con cerniera stagna, collo morbido in rete traspirante e schienalino dorsale. Attivazione automatica UML 38g. Taglia unica per persone oltre i 40 Kg con circonferenza petto 80<->125 cm.



Cod.	Colore	Ricambi	UM	€
3013960	ROSSO		PZ	
3013961	GIALLO		PZ	
3013818		Ricarica automatica UML 38g	PZ	



Cintura Autogonfiabile Solas MED Miramar 300N

Cintura autogonfiabile da 300N approvata SOLAS MED per navigazione da diporto e commerciale senza limiti. Facile da indossare anche su indumenti da lavoro, consente grande libertà di movimento. Con camera di galleggiamento ad alta visibilità a due compartimenti interni con retro stabilizzatore, cover esterna con strisce SOLAS riflettenti, maniglia di sollevamento, fischietto, anello D in Acciaio Inox, doppio tubo orale, doppio sottogamba e chiusura con fibbia entrambi regolabili. Attivazione automatica UML MK5 33g. Taglia unica per persone oltre i 40 Kg.



Cod.	Colore	Ricambi	UM	€
3013980	ROSSO		PZ	
3013817		Ricarica automatica UML MK5 33g	PZ	



7 SICUREZZA SPORT/ABBIGLIAMENTO/BATTELLI ALAGGIO

Cintura Autogonfiabile HH Work Storm 150N

Cintura autogonfiabile Helly Hansen 150N Work Storm EN-ISO12402-3 da lavoro. Leggera, ergonomica, con elementi e cuciture non abrasivi, lascia i movimenti liberi per qualsiasi attività lavorativa in mare. Approvata anche per navigazione da diporto entro e oltre le 6 miglia dalla costa. Si attiva con sistema automatico UML MK5 ma anche manualmente con cordino. Circonferenza petto 55-140 cm, taglia unica per persone oltre i 40 Kg.



Cod.	Colore	Ricambi	UM	€
3013990	NERO		PZ	
3013817		Ricarica automatica UML MK5 33g	PZ	



Cintura Autogonfiabile HH Inshore 170N

Cintura autogonfiabile Helly Hansen Inshore EN-ISO12402-3 da 170N approvata per navigazione da diporto entro e oltre le 6 miglia dalla costa. Leggera, completa di imbrago EN-ISO12401 SailSafe e attivazione con sistema automatico UML. Taglia unica per persone oltre i 40 Kg.



Cod.	Colore	Ricambi	UM	€
3013927	BLUE NAVY		PZ	
3013929	ROSSO		PZ	
3013817		Ricarica automatica UML MK5 33g	PZ	



Cintura Autogonfiabile Mystic 150

Cintura autogonfiabile Secumar da 165N approvata CE ISO12402-2 per diporto senza limiti. Molto sottile e confortevole, garantisce un'elevata libertà di movimento e una galleggiabilità eccezionale. Completa di imbrago certificato CE ISO12401. Attivazione automatica UML MK5 33g e con cordino manuale. Taglia unica per persone oltre i 50 Kg.



Cod.	Colore	Ricambi	UM	€
3013910	NERO		PZ	
3013817		Ricarica automatica UML MK5 33g	PZ	



Cintura Autogonfiabile Arkona 275N

Cintura autogonfiabile Secumar da 275N approvata CE ISO12402-2 per diporto senza limiti. Molto sottile e confortevole, garantisce un'elevata libertà di movimento e una galleggiabilità eccezionale. Completa di imbrago certificato CE ISO12401. Attivazione automatica UML. Taglia unica per persone oltre i 50 Kg.



Cod.	Colore	Ricambi	UM	€
3013909	ROSSO/BLU		PZ	
3013811		Ricarica automatica UML	PZ	



Giubbotto di Galleggiamento Echo 50

Giubbotto Echo 50N per tutti gli sport acquatici approvato ISO EN12402-5. Tessuto antistrappo con imbottitura morbida, molto comoda e vestibile. Chiusura con cerniera, regolazione a cinghia con fibbia a sgancio rapido. 50N - Aiuto al galleggiamento (non è un giubbotto salvagente). Solo per persone che sanno nuotare. Da usare in prossimità della costa.



Cod.	Taglia	Kg x persona	UM	€
3013315	S	30<40	PZ	
3013316	M	40<70	PZ	
3013317	L	70<90	PZ	
3013318	XL	90>120	PZ	

**Giubbotto di Galleggiamento Vivo 50**

Giubbotto Vivo da 50N approvato ISO EN12402-5 per Canoa - Pesca - Sport. Si adatta perfettamente al corpo lasciando libere le braccia. Fabricato in morbida schiuma multistrato di alta qualità. 50N - Aiuto al galleggiamento (non è un giubbotto salvagente). Solo per persone che sanno nuotare. Da usare in prossimità della costa.



Cod.	UM	€
3013322	PZ	

**Giubbotto di Galleggiamento Jump 50**

Giubbotto First Class (by Stearns) da 50N approvato ISO EN12402-5 per vela. Le chiusure laterali permettono di stringere il giubbotto fino ad una perfetta aderenza. Il morbido espanso SECU-Foam protegge il corpo anche in condizioni di regata più difficili. 50N - Aiuto al galleggiamento (non è un giubbotto salvagente). Solo per persone che sanno nuotare. Da usare in prossimità della costa.



Cod.	Taglia	Kg x persona	UM	€
3013305	S	30<40	PZ	
3013306	M	40<70	PZ	
3013307	L	70<90	PZ	
3013308	XL	90>120	PZ	

**Giubbotto di Galleggiamento Wind 50**

Giubbotto Wind 50N approvato ISO EN12402-5 per utilizzo su derive e canoe. Ideale per scuole vela. In tessuto resistente alle abrasioni. Sistema di regolazione composto da nastri e fibbie a sgancio rapido. 50N - Aiuto al galleggiamento (non è un giubbotto salvagente). Solo per persone che sanno nuotare. Da usare in prossimità della costa.



Cod.	Taglia	Kg x persona	Galleggiamento	UM	€
3013130	S	25<>40	40N	PZ	
3013131	M	40<>70	55N	PZ	
3013132	L	70<>80	80N	PZ	

**Giubbotto di Galleggiamento Reef 50**

Giubbotto Reef ergonomico e compatto da 50N approvato ISO EN12402-5. Consigliato dai migliori campioni di hobbie cat. Adatto anche al rafting e sci nautico. Sistema di regolazione composto da 3 cinghie con fibbie a sgancio rapido. 50N - Aiuto al galleggiamento (non è un giubbotto salvagente). Solo per persone che sanno nuotare. Da usare in prossimità della costa.



Cod.	Taglia	Kg x persona	Galleggiamento	UM	€
3010624	S	25<>40	40N	PZ	
3010625	M	40<>70	55N	PZ	
3010626	L	70<>80	70N	PZ	
3010627	XL	80>	80N	PZ	



Giubbotto di Galleggiamento Jet-Pro 50

Giubbotto Jet-Pro da 50N approvato ISO EN12402-5 per sport dinamici come Sci Nautico e Jet Ski. Dotato di protezione dorsale e laterale imbottita e sistema di regolazione composto da 4 cinghie e fibbie a sgancio rapido. 50N - Aiuto al galleggiamento (non è un giubbotto salvagente). Solo per persone che sanno nuotare. Da usare in prossimità della costa.

Cod.	Taglia	Kg x persona	Galleggiamento	UM	€
3010209	M	40<>70	55N	PZ	
3010309	L	70<>80	70N	PZ	
3010409	XL	80>	80N	PZ	

**Giubbotto di Galleggiamento Jobe Short 50**

Giubbotto di aiuto al galleggiamento Jobe 50N, approvato ISO EN12402-5 per sport acquatici di vestibilità corta per maggiore comfort e flessibilità. Leggero e ad asciugatura rapida, con cinghia in tessuto regolabile integrata.

Cod.	Taglia	UM	€
3013470	S	PZ	
3013471	M	PZ	
3013472	L	PZ	
3013473	XL	PZ	
3013474	2XL	PZ	

**New****Giubbotto di Galleggiamento Jobe Universal Vest 50**

Giubbotto Jobe da 50N approvato ISO EN12402-5 per sport acquatici. Costruzione in leggera schiuma PE rivestita in resistente tessuto di Nylon con sistema di drenaggio dell'acqua. Taglia universale per adulti molto versatile grazie alle cinghie regolabili. Chiusura con fibbie YKK a sgancio rapido. 50N - Aiuto al galleggiamento (non è un giubbotto salvagente). Solo per persone che sanno nuotare. Da usare in prossimità della costa.

Cod.	Colore	UM	€
3013420	BLU	PZ	
3013421	ROSSO	PZ	
3013423 New	TEAL	PZ	

**Giubbotto di Galleggiamento Jobe Neoprene Vest 50**

Giubbotto Jobe da 50N approvato ISO EN12402-5 per sci nautico e sport acquatici in confortevole espanso di PVC rivestito di Neoprene. Sistema di drenaggio acqua, chiusura con zip e fibbie a sgancio rapido, cinghie regolabili e anello di sicurezza per recupero d'emergenza. 50N - Aiuto al galleggiamento (per persone che sanno nuotare).

Cod.	Taglia	Colore	UM	€
3013450	S	BLU	PZ	
3013451	M	BLU	PZ	
3013452	L	BLU	PZ	
3013453	XL	BLU	PZ	
3013454	2XL	BLU	PZ	
3013455	S	VERDE LIME	PZ	
3013456	M	VERDE LIME	PZ	
3013457	L	VERDE LIME	PZ	
3013458	XL	VERDE LIME	PZ	
3013459	2XL	VERDE LIME	PZ	

**Giubbotto di Galleggiamento Jobe Youth Vest 50**

Giubbotto Jobe da 50N approvato ISO EN12402-5 per sport acquatici. Costruzione in leggera schiuma PE rivestita in resistente tessuto di Nylon con sistema di drenaggio dell'acqua. Taglia universale per bambini con cinghie regolabili e chiusura con fibbie YKK a sgancio rapido. 50N - Aiuto al galleggiamento (non è un giubbotto salvagente). Solo per persone che sanno nuotare. Da usare in prossimità della costa.

Cod.	Colore	UM	€
3013430	BLU	PZ	
3013432	VERDE LIME	PZ	
3013434 New	TEAL	PZ	



Ski Tube Jobe Rumble

Gonfiabile da traino classico a ciambella in resistente PVC 24G ricoperto con camicia protettiva in Nylon 420D. Con anello da traino rinforzato, valvola Boston, 4 maniglie imbottite con protezione in Neoprene per le nocche e griglia deflusso acqua. Con 3 anni di garanzia dopo registrazione sul sito Jobe.

**JOBE**
WATERSPORTS

Cod.	ø cm	Max persone	Accessori	UM	€
3020112	137	1		PZ	
3030210			Borsa	PZ	

**Ski Tube Jobe Droplet**

Gonfiabile da traino a ciambella chiusa in resistente PVC 24G ricoperto con camicia protettiva in Nylon 420D. Con anello da traino rinforzato, valvola Boston, 4 maniglie imbottite con protezione in Neoprene per le nocche e seduta imbottita con due maniglie aggiuntive in Neoprene. Con 3 anni di garanzia dopo registrazione sul sito Jobe.

**JOBE**
WATERSPORTS

Cod.	ø cm	Max persone	Accessori	UM	€
3020117	134	1		PZ	
3030210			Borsa	PZ	

**Ski Tube Jobe Ridge**

Gonfiabile da traino carenato idrodinamico in resistente PVC 24G ricoperto con camicia protettiva in Nylon 420D. Con anello da traino rinforzato, 2 maniglie imbottite con protezione in Neoprene per le nocche e griglia deflusso acqua. Con 3 anni di garanzia dopo registrazione sul sito Jobe.

**JOBE**
WATERSPORTS

Cod.	Dim cm	Max persone	Accessori	UM	€
3020119	115 x 116	1		PZ	
3030210			Borsa	PZ	

**Ski Tube Jobe Peak**

Gonfiabile da traino carenato idrodinamico in resistente PVC 24G ricoperto con camicia protettiva in Nylon 420D. Con anello da traino rinforzato, 2 maniglie imbottite con protezione in Neoprene per le nocche e griglia deflusso acqua. Con 3 anni di garanzia dopo registrazione sul sito Jobe.

**JOBE**
WATERSPORTS

Cod.	Dim cm	Max persone	Accessori	UM	€
3020125	130 x 120	1		PZ	
3030210			Borsa	PZ	



New

Ski Tube Jobe Hydra

Gonfiabile da traino performante idrodinamico in resistente PVC 20G ricoperto con camicia protettiva in Nylon 420D. Con anello da traino rinforzato e 2 maniglie imbottite con protezione in Neoprene per le nocche. Con 3 anni di garanzia dopo registrazione sul sito Jobe.

Cod.	Dim cm	Max persone	Accessori	UM	€
3020122	137 x 89	1		PZ	
3030210			Borsa	PZ	



**Ski Tube Jobe Proton**

Gonfiabile da traino e da divano relax in resistente PVC 24G ricoperto con camicia protettiva in Nylon 840D. Con anello da traino rinforzato, valvola Boston, 6 maniglie imbottite con protezione in Neoprene per le nocche e seduta imbottita con due maniglie aggiuntive in Neoprene. Con 3 anni di garanzia dopo registrazione sul sito Jobe.

Cod.	Dim cm	Max persone	Accessori	UM	€
3020106	170 x 180 x 75	2		PZ	
3020107	220 x 180 x 75	3		PZ	
3030210			Borsa	PZ	



**Ski Tube Jobe Binar**

Gonfiabile da traino e da divano relax in resistente PVC 28G ricoperto con camicia protettiva in Nylon 840D. Con anello da traino rinforzato, valvola Boston, 7 maniglie imbottite con protezione in Neoprene per le nocche e seduta imbottita con due maniglie aggiuntive in Neoprene. Con 3 anni di garanzia dopo registrazione sul sito Jobe.

Cod.	Dim cm	Max persone	Accessori	UM	€
3020123	206 x 198	2		PZ	
3030210			Borsa	PZ	



**Ski Tube Jobe Chaser**

Gonfiabile da traino classico a banana in resistente PVC 28G ricoperto con camicia protettiva in Nylon 840D. Con anello da traino rinforzato, valvola Boston, maniglie imbottite e sedute con protezione in Neoprene. Con 3 anni di garanzia dopo registrazione sul sito Jobe.

Cod.	Dim cm	Max persone	UM	€
3020202	254 x 110	2	PZ	
3020203	302 x 110	3	PZ	







Tappeto Galleggiante Manta Jobe

Materassino galleggiante, modulare e autogonfiabile Jobe Manta e Mini Manta perfetto per il relax in acqua. Con 4 anelli di ancoraggio agli angoli e cerniere modulari che consentono di collegarlo ad altri gonfiabili Manta. Completo di borsa per riporlo in modo facile e compatto.



Cod.	Ref	Dimensioni cm	UM	€
3020302	Manta	150 x 300 x 6	PZ	
3020304	Mini Manta	150 x 150 x 6	PZ	



Piattaforma Galleggiante Tiki

Resistente piattaforma galleggiante in rete di Poliestere Dropstich ad alta resistenza spalmata PVC con struttura interna a nido d'ape. Si può gonfiare e sgonfiare e può essere facilmente piegata con ingombro minimo. Completa con pagliolo antiscivolo in EVA e d-rings in Acciaio Inox per essere assicurata all'imbarcazione oppure ad altre strutture galleggianti o banchine. Può essere usata come piattaforma ricreativa, come materassino d'acqua oppure come piattaforma da manutenzione per lo scafo.



Cod.	Dimensioni cm	Portata Kg	Peso Kg	UM	€
3020340	150 x 200 x 20	100	11	PZ	
3020342	200 x 200 x 15	150	13	PZ	
3020344	400 x 200 x 20	800	30	PZ	



7 SICUREZZA SPORT/ABBIGLIAMENTO/BATTELLI ALAGGIO



Piscina Infinity Pool Jobe

Piscina Infinity Pool Jobe costruita con tecnologia Heat Bonded di Nylon intrecciato e PVC con nastri di rinforzo sui bordi. Con pagliolo antiscivolo in EVA e rete di contenimento profonda 2m. Presenta inoltre, la possibilità di collegarsi con lepiattaforme Infinity Island (3020312) con estrema facilità. Dotata di scaletta in Acciaio Inox per la risalita, una pompa a batteria (11,6 psi) e una custodia in PVC.

**JOBE**
WATERSPORTS

Cod.	Dimensioni cm	Portata Kg	Peso Kg	UM	€
3020308	400 x 400 x 200	700	39	PZ	

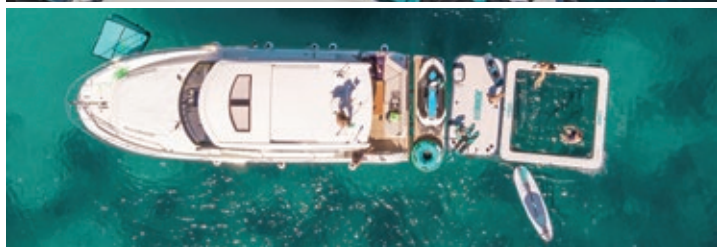
**Piattaforma Infinity Island Jobe**

Piattaforma Infinity Jobe costruita con tecnologia Heat Bonded di Nylon intrecciato e PVC con nastri di rinforzo sui bordi, con pagliolo antiscivolo in EVA. Facilmente assicurabile alla propria imbarcazione grazie ai numerosi d-rings, permette di estendere lo spazio a disposizione per numerose attività. Presenta inoltre, la possibilità di esser collegata con più piattaforme o con l'Infinity Pool (3020308) in maniera rapida e sicura. Dotata di una durevole scaletta in Acciaio Inox per la risalita, una pompa a batteria (11,6 psi) e una custodia in PVC.

**JOBE**
WATERSPORTS

Cod.	Dimensioni cm	Portata Kg	Peso Kg	UM	€
3020312	400 x 200 x 15	700	42	PZ	

**Paracolpi Infinity Bumper Jobe**

Il paracolpi Infinity Bumber Jobe costruito in EVA previene possibili danni a Inifinty Pool (3020308) e Infinity Island (3020312). Inoltre, impedisce alla piattaforma Infinity Island di rimanere incastrata sotto la plancia di poppa. Si raccomanda l'uso di almeno due Bumper.

**JOBE**
WATERSPORTS

Cod.	Dimensioni cm	UM	€
3020314	60 x 45 x 33	PZ	

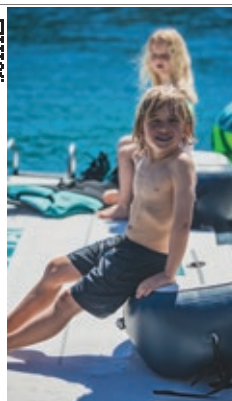

Sci d'Acqua Jobe Allegre Combo 170

Sci d'acqua Jobe progettati con la giusta combinazione tra prestazioni e manovrabilità. Costruiti con struttura ad iniezione di fibra e rinforzi metallici ad asta per una maggiore rigidità e rifiniti con strato lucido protettivo. Completi con attacchi rinforzati regolabili da 36 a 47 e pinna ad alta visibilità. La versione package contiene in più la borsa per contenere gli sci, 18 m corda da traino, giubbotto di galleggiamento universale e bandiera di segnalazione per acqua sport.

Cod.	Ref	Colore	L cm	UM	€
3004007	Sci con attacchi	BLU	170	CP	
3004009	Sci con attacchi	ROSSO	170	CP	
3004017	Sci package completo	BLU	170	CF	
3004019	Sci package completo	ROSSO	170	CF	

**Wakeboard Jobe Logo**

Wakeboard Jobe progettato con la giusta combinazione tra prestazioni e manovrabilità. Costruzione tradizionale in espanso e fibra di vetro a tecnologia ABS con strato lucido protettivo e pinne sagomate. Completo con attacchi regolabili da 36 a 47. La versione package contiene in più la borsa per contenere il wakeboard e 16 m di corda da traino.

Cod.	Ref	L cm	UM	€
3007003	Wakeboard con attacchi	138	PZ	
3007002	Wakeboard package completo	138	CF	

**Tavola Jobe Stimmel Package**

La tavola da spiaggia Jobe Stimmel Multiposition rappresenta un prodotto innovativo All-In-One perché può essere utilizzata come wakeboard, sci, wakeskate e wakesurf con un minimo di 6 posizioni. Dotata di comoda fodera antiscivolo in EVA, impugnatura laterale stampata ad iniezione con gancio di traino integrato e pinne surf rimovibili. Completa di corda da traino con manico e borsa.

Cod.	Dim cm	UM	€
3007025	151 x 62 x 5	PZ	



New



Caschetto Jobe Victor

Caschetto Jobe progettato per sport acquatici. Con cinghia di chiusura regolabile, cuscinetti auricolari di protezione ed inserti interni rimovibili.

Cod.	Taglia	UM	€
3019300	Medium	PZ	
3019302	Large	PZ	

**JOBE**
WATERSPORTS**Braccialetto di Sicurezza**

Braccialetto di sicurezza Jobe regolabile con anello a D. Ideale per collegare cime e chiavette di sicurezza.

Cod.	UM	€
3015080	PZ	

**JOBE**
WATERSPORTS**Triangolo da Traino**

Triangolo con puleggia carenato in Plastica rinforzata per corda traino. Si usa per tenere la poppa e l'elica libera dalla corda di traino.

Cod.	L cima cm	UM	€
3015830	290	PZ	

**Triangolo da Traino Jobe**

Triangolo completo con moschettoni per corda traino. Si usa per tenere la poppa e l'elica libera dalla corda di traino.

Cod.	L cima cm	Carico di rottura Kg	UM	€
3015515	240	1077	PZ	

**JOBE**
WATERSPORTS**Corda Traino Ski Tube Jobe**

Corda da traino galleggiante pronta all'uso per ski tube.

Cod.	Carico di traino	L m	Carico di rottura Kg	UM	€
3015516	1 o 2 persone	15,2	1077	PZ	
3015517	3 o 4 persone	16,8	1882	PZ	

**JOBE**
WATERSPORTS**Corda Traino Sci Jobe**

Corda da traino per sci d'acqua resistente ai raggi UV con comoda e resistente maniglia in EVA. Lavorazione a 16 fusi. Carico di rottura 550Kg.

Cod.	L m	ø mm	UM	€
3015025	20	8	PZ	



New

JOBE
WATERSPORTS**Corda Traino Sci Sport**

Corda da traino per sci d'acqua.

Cod.	L m	ø mm	UM
3015020	23	8	PZ

**Corda Traino Sci America**

Corda da traino per sci d'acqua.

Cod.	L m	ø mm	UM
3015520	22	8	PZ

**Corda Traino Sci Master**

Corda da traino per sci d'acqua.

Cod.	L m	ø mm	UM
3015023	23	12	PZ



Moschettone da Sci Nautico

Moschettone a sgancio rapido in Acciaio Inox AISI 316 per sci nautico.

Cod.	L mm	O mm	Tipo	UM	€
0223000	60	16	Standard	PZ	
0223002	60	16	Approvato R.I.Na.	PZ	

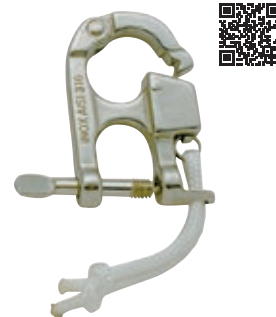
**Anello Traino Sci**

Anello traino sci in Acciaio Inox. Si monta a poppa.

Cod.	∅ mm	Perni mm	UM	€
3015006	60	75 x 10	PZ	
3015008	80	95 x 12	PZ	

**Asta Traino Sci Pop-Up**

Asta da traino a scomparsa in Acciaio Inox AISI 316 per sci nautico. Il perno ruota di 360° e può essere usato anche come bitta.

Cod.	A mm	B mm	C mm	D mm	E mm	F mm	G mm	UM	€
3015012	15	68	48	37	145	16	76	PZ	

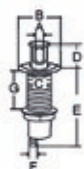
**Asta Traino Sci**

Asta da traino per sci nautico in Acciaio Inox, si monta a poppa.

Cod.	∅ mm	H mm	UM	€
3015010	40	1100	PZ	

**Specchio Retrovisore Standard**

Specchio retrovisore convesso da cruscotto o parabrezza. In ABS cromato. Attacco snodato e regolabile, visibilità di 108°.

Cod.	Dim mm	UM	€
3016000	200 x 95	PZ	

**Specchio Retrovisore Panoramico**

Specchio retrovisore panoramico da parabrezza o cruscotto in lega laccata bianca. Con supporto snodato e attacco universale a morsetto fino a 25 mm.

Cod.	Dim mm	UM	€
3016006	260 x 100	PZ	



Sup Board Jobe Aero Mohaka

Tavola Sup gonfiabile Jobe molto resistente costruita con tecnologia Heat Bonded in tessuto di Nylon intrecciato e PVC con nastri di rinforzo sui bordi. Con due pinne stabilizzatrici da 20cm e due alette laterali, pagliolo antiscivolo in EVA, alloggio per montaggio di qualsiasi vela da windsurf, anello a D a prua e a poppa e valvola di gonfiaggio Halkey. Completa di pompa a doppia azione, laccio di sicurezza da 3 m, pagaia divisibile in Alluminio e zaino impermeabile. Con 3 anni di garanzia dopo registrazione sul sito Jobe.

JOBE
WATERSPORTS

Cod.	Dim cm	Portata Kg	Peso Kg	UM	€
2910316	309 x 78,7 x H15	120	9,2	CF	

**Sup Board Jobe Aero Mira**

Tavola Sup gonfiabile Jobe molto leggera e resistente costruita con tecnologia Heat Bonded in tessuto di Nylon intrecciato e PVC con nastri di rinforzo sui bordi. Con pinna stabilizzatrice flessibile, pagliolo antiscivolo in EVA, anello a D a prua e a poppa e valvola di gonfiaggio Halkey. Completa di pompa a doppia azione, laccio di sicurezza da 3 m, pagaia divisibile in Alluminio e zaino impermeabile. Con 3 anni di garanzia dopo registrazione sul sito Jobe.



Cod.	Dim cm	Portata Kg	Peso Kg	UM	€
2910321	305 x 81 x H12	100	7,5	CF	

**Sup Board Jobe Aero Yarra**

Tavola Sup gonfiabile Jobe molto leggera e resistente costruita con tecnologia Heat Bonded in tessuto di Nylon intrecciato e PVC con nastri di rinforzo sui bordi. Con pinna stabilizzatrice, pagliolo antiscivolo in EVA, rete ferma oggetti elastica, anello a D a prua e a poppa e valvola di gonfiaggio Halkey. Completa di pompa a doppia azione, laccio di sicurezza da 3 m, pagaia divisibile in fibra e zaino impermeabile. Con 3 anni di garanzia dopo registrazione sul sito Jobe.



Cod.	Dim cm	Portata Kg	Peso Kg	UM	€
2910312	320 x 81 x H15	120	8,4	CF	

**Zaino Jobe Aero Sup Travel Bag**

Zaino Jobe ideale per il trasporto di tutte le tavole Sup "Aero". Con rotelle, spallacci imbottiti e sei maniglie per un comodo spostamento. Al suo interno presenta due lacci per assicurare la pompa e la propria tavola.



Cod.	Dim cm	UM	€
3030208	93 x 45 x 25	PZ	

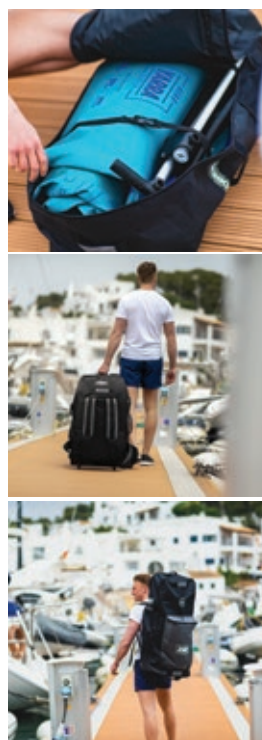

Tender EV l'Arrotolabile

Tender in tessuto PVC ad alta resistenza 1100D molto agile, leggero e facilmente avvolgibile. Dotato di ampi tubolari e fondo rigido a stecche. Dotazione di serie: pagaie, panchetta, gonfiatore, kit riparazione e sacco porta battello 80 x 35 x 50 cm.



Cod.	L cm	W cm	Tubo ø cm	Peso Kg	HP max	n.Persone	Dim piegato	UM	€
2910418	185	131	36	22	2,5	2	80x30x45	PZ	
2910421	210	131	34	23	4	2	80x35x45	PZ	
2910424	240	131	36	32	4	2	85x35x45	PZ	



Tender EV il Gonfiabile

Tender compatto in tessuto PVC ad alta resistenza 1100D con fondo gonfiabile ad alta rigidità che assicura un piano di appoggio confortevole conferendo rigidità e stabilità di navigazione. Dotazione di serie: pagaie, panchetta regolabile, gonfiatore, kit riparazione e sacco porta battello 80 x 40 x 50 cm.



Cod.	L cm	W cm	Tubo ø cm	Peso Kg	HP max	n.Persone	Dim piegato	UM	€
2910518	180	129	35	16,5	2,5	1+1	70x40x50	PZ	
2910520	200	129	35	17,2	3,5	2	80x40x50	PZ	
2910523	230	130	35	18,5	4,0	2	80x40x50	PZ	
2910526	260	131	37	21	5,5	3	85x40x50	PZ	



Tender EV il Riponibile

Tender compatto in tessuto PVC ad alta resistenza 1100D con fondo gonfiabile irrobustito da listelli in Alluminio Anodizzato ad alta rigidità che assicurano un piano di appoggio confortevole conferendo rigidità e stabilità di navigazione.

Dotazione di serie: pagaie, panchetta regolabile, gonfiatore, kit riparazione e sacco porta battello 80 x 40 x 50 cm.



Cod.	L cm	W cm	Tubo ø cm	Peso Kg	HP max	n.Persone	Dim piegato	UM	€
2911323	230	151	42	38	4	2	85x40x50	PZ	
2911327	270	174	42	48	10	3+1	95x45x55	PZ	
2911329	290	155	42	52	10	4	95x60x60	PZ	
2911332	320	212	42	55	15	4+1	100x70x60	PZ	



7 SICUREZZA SPORT/ABBIGLIAMENTO/BATTELLI ALAGGIO

Tender EV il Semirigido

Tender in tessuto PVC ad alta resistenza 1100D con fondo rigido a conformazione particolare che consente un celere e stabile ingresso in planata anche con motorizzazioni ridotte. Con ampi tubolari che assicurano una navigazione confortevole dotati di bottaccio conformato per evitare ingressi di acqua in coperta.

Dotazione di serie: pagaie, panchetta, gonfiatore e kit riparazione.



Cod.	L cm	W cm	Tubo ø cm	Peso Kg	HP max	n.Persone	UM	€
2910820	202	124,5	36	37	4	2	PZ	
2910822	222	142,5	36	39	4	2	PZ	
2910825	250	172	43	50	7,5	3	PZ	
2910828	285	210	43	65	10	3	PZ	

**Tender EV l'Ultraleggero**

Tender in tessuto ad alta resistenza con doppia spalmatura PVC 1100Dtex con carena rigida in Alluminio Anodizzato trattato a conformazione particolare che consente un celere e stabile ingresso in planata anche con motorizzazioni ridotte. Molto leggero, con sottovalvola di pressione di gonfiaggio e ampi tubolari che assicurano una navigazione confortevole. Il modello 250 e 270 hanno carena singola senza gavone di prua, il modello 290 ed il 320 hanno il gavone di prua con portellino. Dotazione di serie: pagaie, panchetta, gonfiatore e kit riparazione.



Cod.	L cm	W cm	Tubo ø cm	Peso Kg	HP max	n.Persone	UM	€
2911425	250	149	42	38	5	2	PZ	
2911427	270	149	42	38	8	2+1	PZ	
2911429	290	155	42	54	10	4	PZ	
2911432	320	156	42	64	15	4+1	PZ	

**Rolling Seat**

Sedili gonfiabili tondi in PVC rinforzato.



Cod.	L mm	ø mm	UM	€
2920432	600	300	PZ	
2920433	700	300	PZ	
2920434	800	300	PZ	

**Cassapanche in Vetroresina**

Robuste cassapanche in Vetroresina.



Cod.	L mm	W mm	H mm	UM	€
0832005	600	450	400	PZ	
0832008	790	450	400	PZ	

**Plancia Timoneria**

Plancia di timoneria in Vetroresina con portello 27 x 37 cm.



Cod.	L mm	W mm	H mm	UM	€
4638030	305	425	655	PZ	



Gonfiatore Bravo 6

Gonfiatore a mano doppio flusso Bravo 6 con raccordi multipli. Tramite un tappo può diventare a flusso semplice per gonfiare alla massima pressione senza sforzo. Dimensioni 21 x 12 x H47 cm.

Cod.	Portata Lt	Pressione max mbar	Accessori	UM	€
2930006	2 x 2,5	600		PZ	
2931001			Manometro	PZ	



Gonfiatore GM5

Gonfiatore manuale a flusso singolo/doppio commutabili, può gonfiare e sgonfiare. Corpo in ABS con camera interna in Alluminio Circal. Maniglia smontabile, piedi base pieghevoli, tubo da 1,25 m e raccordi multipli, manometro e convertitore a flusso singolo per ridurre lo sforzo e raggiungere la pressione massima. Dimensioni 17 x 16 x H51 cm quando piegato senza maniglia.

Cod.	Portata Lt	Pressione max mbar	UM	€
2930005	2 x 2,4	1000	PZ	



Gonfiatore GM6

Gonfiatore manuale a flusso singolo/doppio commutabili, può gonfiare e sgonfiare. Corpo in ABS e Alluminio con maniglia ergonomica, base allargata, raccordi multipli, manometro, filtro e convertitore a flusso singolo per ridurre lo sforzo e raggiungere la pressione massima. Dimensioni 17 x 30 x H58 cm.

Cod.	Portata Lt	Pressione max mbar	UM	€
2930010	2 x 2,5	1000	PZ	



Gonfiatore GM NXS

Gonfiatore manuale di qualità superiore a flusso singolo/doppio commutabili, può gonfiare e sgonfiare. Particolarmente adatto per SUP ed alte pressioni. Corpo e camera interna in Alluminio Circal, maniglia ergonomica con filtro aria integrato, base allargata, tubo e raccordi multipli, manometro e convertitore a flusso singolo per ridurre lo sforzo e raggiungere la pressione massima. Dimensioni 14 x 30 x H58 cm.

Cod.	Portata Lt	Pressione max mbar	UM	€
2930008	2 x 1,5	2000	PZ	



Gonfiatore Bravo 1

Gonfiatore a pedale Bravo 1 con parti metalliche in Acciaio Inox e raccordi multipli. Dimensioni 26 x 20 x H8 cm.

Cod.	Portata Lt	Pressione max mbar	UM	€
2930001	4	500	PZ	



Gonfiatore GP5

Gonfiatore a pedale GP5 completo di raccordi multipli. Dimensioni 29 x 22 x H8 cm.

Cod.	Portata Lt	Pressione max mbar	UM	€
2930022	5	400	PZ	



Gonfiatore GP10

Gonfiatore a pedale GP10 a doppia camera che consente di raggiungere senza sforzo la pressione massima. Con indicatore visivo di pressione eccessiva e raccordi multipli. Dimensioni 35 x 25 x H8 cm.

Cod.	Portata Lt	Pressione max mbar	UM	€
2930030	5,5	800	PZ	



Gonfiatore GE BP

Gonfiatore GE BP con arresto automatico alla pressione selezionata. Completo di filtro di aspirazione, sacca con tracolla, tubo da 1,70 metri e 3 metri di cavo. Alimentazione con spina accendisigari 12V oppure con morsetti per batteria. Consumo massimo 13A. Dimensioni: 21 x 11 x H13 cm.



Cod.	V	Portata Lt/min	Pressione max mbar	UM	€
2930057	12	160	1200	PZ	



Gonfiatore GE BTP Manometer

Gonfiatore GE BTP con arresto automatico alla pressione selezionata tramite manometro con scala in bar e psi. Può gonfiare o sgonfiare. Completo di filtro di aspirazione, raccordi universali, sacca con tracolla, tubo da 1,70 metri e 3 metri di cavo. Alimentazione con spina accendisigari 12V oppure con morsetti per batteria. Consumo massimo 13A. Dimensioni: 30 x 11 x H16 cm.



Cod.	V	Portata Lt/min	Pressione max mbar	UM	€
2930056	12	420	1000	PZ	



Gonfiatore GE 10

Gonfiatore elettrico ad alta velocità GE 10. Grazie al motore a due stadi può gonfiare o sgonfiare un battello da 4 metri in 5 minuti. Con borsetta a tracolla, tubo da 1,7 metri e raccordi multipli. Alimentazione con morsetti per batteria oppure con spina accendisigari 12V. Consumo massimo 13A. Dimensioni: 11 x 16 x 24 cm.



Cod.	Ref	V	Portata Lt/min	Pressione max mbar	UM	€
2930058	GE 10-3	12	450	300	PZ	
2930059	GE 10-8	12	450	800	PZ	



Gonfiatore GE 10-B Battery

Gonfiatore elettrico ad alta velocità GE 10-B. Grazie al motore a due stadi può gonfiare o sgonfiare un battello da 4 metri in 5 minuti. Con borsetta a tracolla, tubo da 1,7 metri e raccordi multipli. Alimentazione con batteria ricaricabile integrata oppure con spina accendisigari 12V. Consumo massimo 13A. Dimensioni: 12 x 16 x 31 cm.



Cod.	V	Portata Lt/min	Pressione max mbar	UM	€
2930053	12	450	800	PZ	



Gonfiatore Turbo Max

Gonfiatore elettrico 12V Turbo Max ad alta velocità con arresto automatico a pressione raggiunta. Può gonfiare o sgonfiare un gommone da 7 metri in 7 minuti. Completo di cavo alimentazione da 1,7 metri, tubo aria da 2,8 metri, fusibile di sicurezza e borsa con tracolla. Consumo massimo 60A. Dimensioni: 31 x 18 x H19 cm.



Cod.	V	Portata Lt/min	Pressione max mbar	Ricambi	UM	€
2930070	12	1000	250		PZ	
2931010				Kit tubo + raccordi	PZ	



Gonfiatore Turbo Max Kit

Gonfiatore a installazione fissa Turbo Max Kit con arresto automatico alla pressione impostata. Può gonfiare e sgonfiare un battello pneumatico da 7 metri in 7 minuti. Completo di staffe per il fissaggio, viti e cavo alimentazione da 0,5 metri. Consumo massimo 60A. Dimensioni: 30 x 16 x 7 cm. Altezza incasso 6 cm.



Cod.	V	Portata Lt/min	Pressione max mbar	Accessori	UM	€
2930069	12	1000	250		PZ	
2931010				Kit tubo + raccordi	PZ	

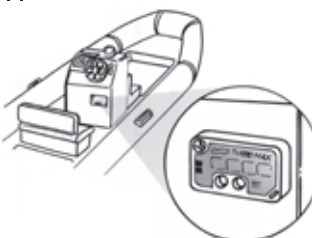

Gonfiatore EG Inflater-220V

Gonfiatore compatto ma potente alimentato a 220V. Può gonfiare e sgonfiare. Completo di attacco per gommoni e boe da regata. Con 1 metro di tubo, consumo 800W. Dimensioni 20 x 13 x H15 cm.

Cod.	V	Portata Lt/min	Pressione max mbar	UM	€
2930080	230	1600	170	PZ	



Gonfiatore GE OV4-220V

Gonfiatore GE OV4 alimentato a 220V. Può gonfiare e sgonfiare. Completo di filtro aria, tubo da 1,5 metri e raccordi universali. Consumo 400W. Dimensioni: 12 x 15 x 15 cm.

Cod.	V	Portata Lt/min	Pressione max mbar	UM	€
2930065	230	950	150	PZ	



Gonfiatore GE OV6-220V

Gonfiatore GE OV6 alimentato a 220V. Può gonfiare e sgonfiare. Completo di filtro aria, tubo da 1,5 metri e raccordi universali. Consumo 600W. Dimensioni: 15 x 16 x 17 cm.

Cod.	V	Portata Lt/min	Pressione max mbar	UM	€
2930063	230	1600	175	PZ	



Gonfiatore GE 900

Gonfiatore elettrico 220V in grado di portare a pressione in breve tempo qualsiasi struttura gonfiabile. Motore da 700W progettato con impatto acustico ridotto (max 85 dB), può gonfiare e sgonfiare. Da completare con tubo e raccordi che vengono forniti a parte. Dimensioni 15 x 17 x H22 cm.

Cod.	V	Portata Lt/min	Pressione max mbar	Accessori	UM	€
2930068	230	1700	200		PZ	
2931014				Tubo D25 con raccordo standard per gonfiabili leggeri	PZ	
2931015				Tubo D25 con raccordo per valvole 2005	PZ	
2931016				Tubo D40 con raccordo per valvole 260HV	PZ	



Gonfiatore GE 230/1000

Gonfiatore elettrico professionale 220V in grado di portare a pressione in breve tempo qualsiasi gomma e struttura gonfiabile. Completo di raccordi multipli, può gonfiare e sgonfiare. Consumo 1100W. Dimensioni dia 17 x H27 cm.

Cod.	V	Portata Lt/min	Pressione max mbar	UM	€
2930067	230	1500	230	PZ	



Gonfiatore GE 230/2000

Gonfiatore elettrico 220V ad alta velocità con motore supplementare selezionabile che aumenta la portata e la pressione per gonfiare o sgonfiare qualsiasi gomma e struttura gonfiabile in breve tempo. Completo di fusibile di protezione, raccordi multipli e cavo di alimentazione da 3 metri. Consumo 1000W (2000W con booster). Dimensioni 32 x 17 x H26 cm.

Cod.	V	Portata Lt/min	Pressione max mbar	UM	€
2930061	230	1200 (2000 con booster)	140 (350 con booster)	PZ	



SICUREZZA SPORT/ABBIGLIAMENTO/BATTELLI ALAGGIO

7

Maniglia Evo

Maniglia in Gomma.

Cod.	mm	Colore	UM	€
2915003	260 x 95	GRIGIO	PZ	
2915103	260 x 95	NERO	PZ	

**Maniglia Synt**

Maniglia in Gomma.

Cod.	mm	Colore	UM	€
2915002	240 x 105	GRIGIO	PZ	
2915102	240 x 105	NERO	PZ	

**Piastra Passacorda Eco**

Piastra passacorda in PVC. Foro 13 mm.

Cod.	ø mm	Colore	UM	€
2915113	ø 75 x H19	GRIGIO	PZ	
2915117 	ø 75 x H19	NERO	PZ	

**Piastra Passacorda Mil**

Passacorda in Gomma ø 17 mm.

Cod.	mm	Colore	UM	€
2915010	95 x 95	GRIGIO	PZ	
2915110	95 x 95	NERO	PZ	

**Piastra con Anello Inox Mil**

Piastra in Gomma con anello D Inox.

Cod.	mm	Colore	UM	€
2915014	95 x 95	GRIGIO	PZ	
2915114	95 x 95	NERO	PZ	

**Fissapala Synt**

Piastra fissapala in Gomma. Elastico non compreso.

Cod.	mm	Colore	UM	€
2915028	90 x 58	GRIGIO	PZ	
2915128	90 x 58	NERO	PZ	

**Fissaremi Mil**

Gancio fissaremi in Gomma.

Cod.	mm	Colore	UM	€
2915006	115 x 95	GRIGIO	PZ	
2915106	115 x 95	NERO	PZ	

**Scalmiera su Piastra B**

Scalmiera in Gomma con perno D11 mm.

Cod.	mm	UM	€
2915020	200 x 95	PZ	

**Scalmiera su Piastra F**

Scalmiera in Gomma con perno di aggancio abbattibile D11 mm.

Cod.	mm	Colore	UM	€
2915023	150 x 95	GRIGIO	PZ	
2915123	150 x 95	NERO	PZ	

**Scalmiera su Piastra S**

Scalmiera in Gomma con perno di aggancio D11 mm.

Cod.	mm	Colore	UM	€
2915022	150 x 95	GRIGIO	PZ	
2915122	150 x 95	NERO	PZ	

**Bitta Bollard Compact**

Bitta di prua a base corta con strozzacima da 12<>16 mm.

Cod.	mm	Colore	UM	€
2915143	160 x 320 x H60	NERO	PZ	
2915153	160 x 320 x H60	GRIGIO	PZ	

**Profili in Gomma a Metro**

Profili in Gomma per la protezione dei tubolari.

Cod.	Colore	UM	€
3835990	GRIGIO	MT	
3835991	NERO	MT	



Valvola Boston

Tappo con valvola di non ritorno tipo Boston in Nylon per gonfiabili leggeri.

Cod.	UM	€
2915601	PZ	

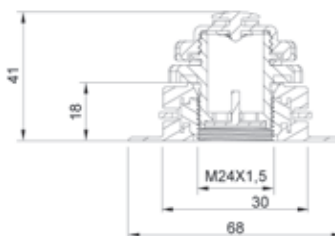

Valvola Bravo 260HV

Valvola compatta ad ampio flusso per grandi strutture gonfiabili ad alta e bassa pressione. Con apertura push-turn e guarnizione a labbro in silicone a massima tenuta.

Cod.	Ref	UM	€
2915604	Valvola Bravo 260HV	PZ	
2915609	Chiave serraggio	PZ	

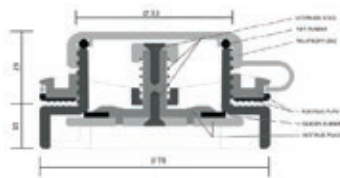

New



Valvola Bravo 2005

Valvola compatta con tappo ergonomico per gonfiabili ad alta e bassa pressione. Con apertura push e guarnizione a labbro in silicone a massima tenuta.

Cod.	Ref	UM	€
2915605	Valvola Bravo 2005	PZ	
2915608	Chiave serraggio	PZ	

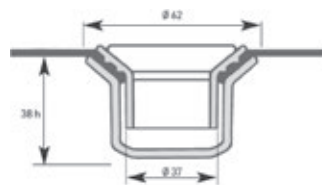

Valvole Profi

Valvola di gonfiaggio e sgonfiaggio per canotti pneumatici. Foro tessuto Ø 35 mm.

Cod.	Ref	UM	€
2915610	Valvola Profi tappo pieno	PZ	
2915612	Valvola Profi tappo farfalla	PZ	
2915614	Chiave serraggio	PZ	



Valvola di Sovrapressione

Valvola di sovrappressione da inserire tra la pompa e il battello. Raggiunta la pressione ottimale, la valvola scarica l'aria in eccesso.

Cod.	UM	€
2915618	PZ	

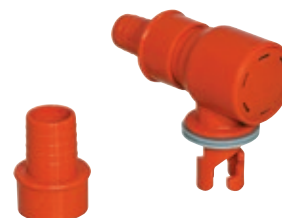

Manometro Pressione

Manometro per rilevare la pressione dei canotti pneumatici.

Cod.	UM	€
2915616	PZ	



Kit Riparazione Mini

Mini Kit con adesivo e pezze per la riparazione di gonfiabili in PVC.

Cod.	UM	€
5722801	CF	



Kit Riparazione Gommoni

Kit riparazione gommoni (adesivo + pezze + attrezzi). Per battelli in tessuto spalmato Neoprene o PVC.

Cod.	Kit	UM	€
5722803	Neoprene	CF	
5722804	PVC	CF	



SICUREZZA SPORT/ABBIGLIAMENTO/BATTELLI ALAGGIO

7

Carrello Porta Canoe

Carrello porta canoa e porta surf con appoggio morbido e cinghia di serraggio. Pieghevole e smontabile.

Cod.	H cm	W cm	Peso Kg	UM	€
2802223	40	68	2,8	PZ	

**Ruote Alaggio di Poppa Rimovibili**

Sistema di alaggio pieghevole rimovibile per alare canotti pneumatici e piccole imbarcazioni. Supporti e giunti in Acciaio Inox. Fissaggio con morsetto.

Cod.	Ø Tubi mm	UM	€
2805072	32	CP	

**Ruote Alaggio Dinghy Wheeler**

Ruote di poppa in materiale plastico rinforzato per alare canotti pneumatici e piccole imbarcazioni. Si sollevano durante la navigazione. Costruite in materiale leggero e anticorrosione, sono esenti da manutenzione.

Cod.	Portata Kg	UM	€
2805070	115	CP	

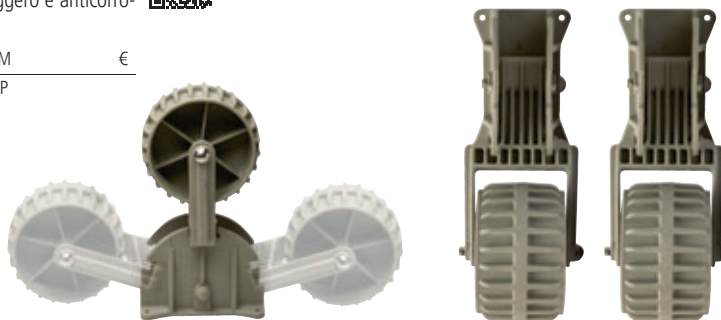
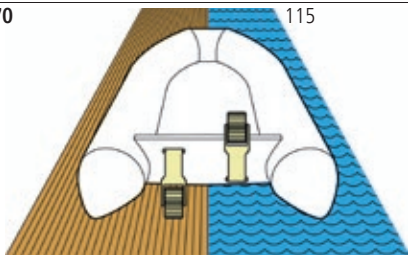
**Ruote Alaggio di Poppa Standy**

Ruote di poppa per alare canotti pneumatici e piccole imbarcazioni. Si sollevano o si tolgono durante la navigazione. Supporti e giunti in Acciaio Inox.

Cod.	Portata Kg	UM	€
2805057	130	CP	

**Ruote Alaggio di Poppa Sagomate**

Ruote di poppa per alare canotti pneumatici e piccole imbarcazioni. Si sollevano o si tolgono durante la navigazione. Supporti e giunti in Acciaio Inox.

Cod.	Portata Kg	UM	€
2805058	150	CP	

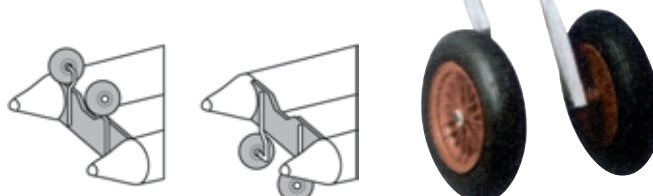

Cavalletto Porta Motore Standard

Cavalletto porta motore pieghevole in Acciaio Zincato con tavoletta in Legno.



Cod.	Portata Kg	H cm	UM	€
2800050	50	90	PZ	

**Cavalletto Porta Motore Extra**

Robusto cavalletto porta motore pieghevole in Acciaio Zincato con tavoletta in Legno.



Cod.	Portata Kg	H cm	UM	€
2800090	90	100	PZ	

**Cavalletto Porta Motore Regolabile**

Cavalletto porta motore con maniglia e base regolabili per ogni esigenza. Facilmente smontabile per un agevole trasporto e stivaggio. Ottime caratteristiche di resistenza e portata. Tavoletta in legno Iroko.



Cod.	Portata Kg	H cm	UM	€
2802026	65	66 < 93	PZ	

**Cavalletto Porta Motore Standard Roll**

Cavalletto porta motore su ruote. Telaio in Acciaio Zincato con tavoletta in Legno e portaserbatoio.



Cod.	Portata Kg	H cm	UM	€
2802020	50	90	PZ	

**Cavalletto Porta Motore Extra Roll**

Cavalletto porta motore su ruote pneumatiche. Telaio in Acciaio Zincato con tavoletta in Legno e portaserbatoio.



Cod.	Portata Kg	H cm	UM	€
2802022	50	95	PZ	



Rulli Centrali

Rulli alaggio centrali in gomma.

MADE IN ITALY 

Cod.	L mm	ø mm	ø Foro mm	UM	€
2805049	130	80	15	PZ	
2805051	130	70	15	PZ	
2805052	215	80	20	PZ	

**Rulli Laterali**

Rulli alaggio laterali in gomma.

MADE IN ITALY 

Cod.	L mm	ø mm	ø Foro mm	UM	€
2805050	75	105	15	PZ	
2805054	106	85	15	PZ	
2805056	170	65<>200	15	PZ	

**Piastre**

Piastre in gomma per carrelli.

MADE IN ITALY 

Cod.	Ref	H mm	L mm	UM	€
2805041	Prua	60	165	PZ	
2805042	Sella	90	500	PZ	

**Rulli Centrali Domar**

Rulli alaggio centrali in Nylon rivestito di Poliuretano blu.

MADE IN ITALY 

Cod.	L mm	ø mm	ø Foro mm	UM	€
2805015	206	98	16	PZ	
2805016	206	98	21	PZ	
2805017	130	80	16	PZ	

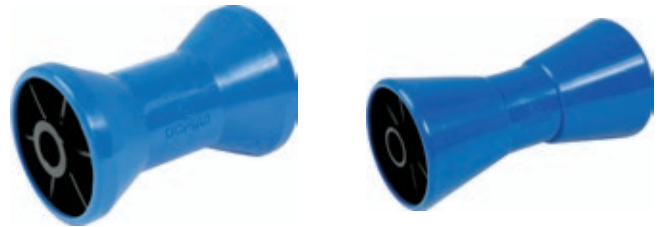
**Rulli Laterali Domar**

Rulli alaggio laterali flottanti in Nylon rivestito di Poliuretano blu.

MADE IN ITALY 

Cod.	L mm	ø mm	ø Foro mm	UM	€
2805010	74	120	15	PZ	
2805011	74	120	21	PZ	

**Ferma Prua Domar**

Ferma prua in Poliuretano blu.

Diametro foro 11 mm lunghezza 73 mm.

MADE IN ITALY 

Cod.	Dim mm	UM	€
2805020	150 x 70 x H80	PZ	

**Selle Domar**

Selle in gomma nera per carrelli.

MADE IN ITALY 

Cod.	Dim mm	UM	€
2805218	120 x 100 x H32,5	PZ	
2805219	300 x 100 x H32,5	PZ	

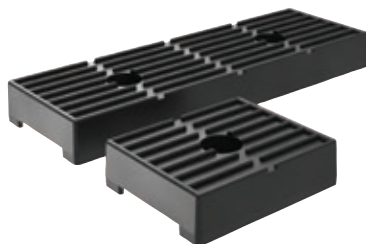
**Cuneo di Arresto Domar**

Cuneo di Arresto in Plastica nera. I veicoli di massa complessiva massima a pieno carico superiore a 3,5 tonnellate devono essere muniti di cunei bloccaruote (art. 353 codice della strada).

MADE IN ITALY 

Cod.	Ref	Dim mm	UM	€
2805220	Cuneo	90 x 225 x H100	PZ	
2805221	Supporto di Appoggio		PZ	

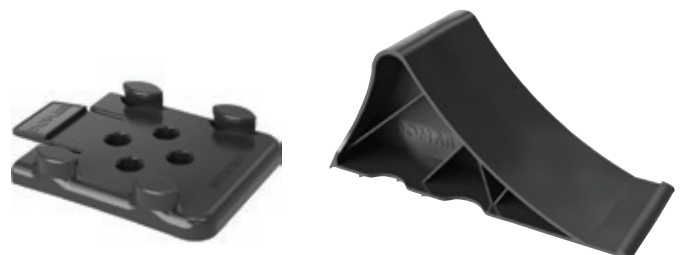

Staffe per Rulli Centrali Domar

Staffe in acciaio zincato per rulli centrali, vendute in coppia.

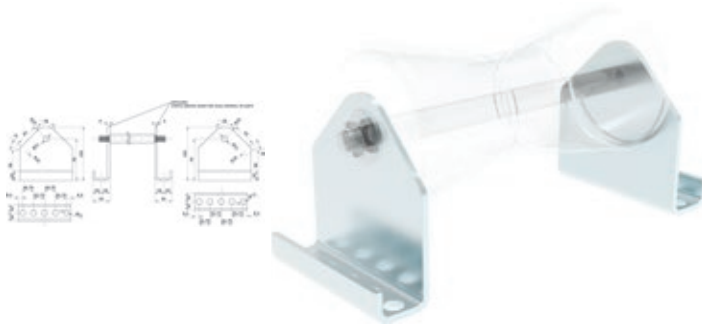

Cod.	Dimensioni mm	UM	€
2805200	100 x H102	CP	

**Angolari per Rulli Centrali Domar**

Angolari in Acciaio Zincato per rulli centrali, venduti in coppia.



Cod.	Dimensioni mm	UM	€
2805205	250 x H40	CP	

**Perni per Rulli Centrali Domar**

Perni per rulli centrali.

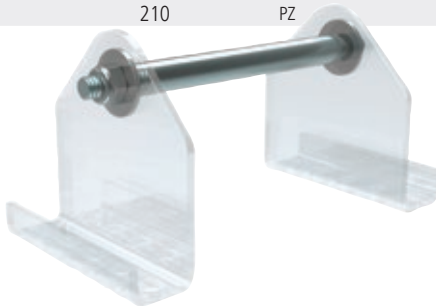

Cod.	ø mm	Lunghezza mm	UM	€
2805225	15	194	PZ	
2805226	15	210	PZ	
2805227	20	194	PZ	
2805228	20	210	PZ	

**Staffa Fissaggio Ferpaprua Domar**

Staffa di fissaggio regolabile per ferpaprua in Acciaio Zincato.

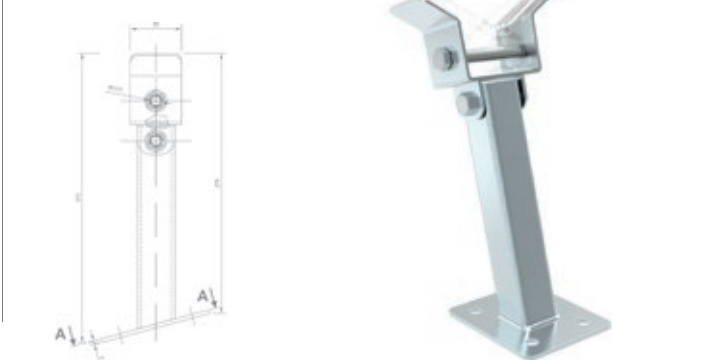

Cod.	Dimensioni mm	UM	€
2805215	220 x H40	PZ	

**Staffa per Rullo Laterale Doppio Domar**

Staffa per rullo laterale doppio.

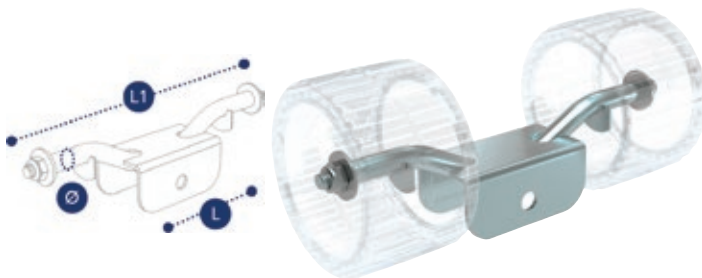

Cod.	ø mm	L mm	L1 mm	UM	€
2805210	15	100	270	PZ	

**Staffa per Rullo Laterale Quadruplo Domar**

Staffa per rullo laterale quadruplo.



Cod.	ø mm	L mm	L1 mm	C mm	UM	€
2805211	15	54	270	230	PZ	

**Staffa con Due Rulli Laterali Domar**

Staffa con perno mobile completa di due rulli laterali (2805010).

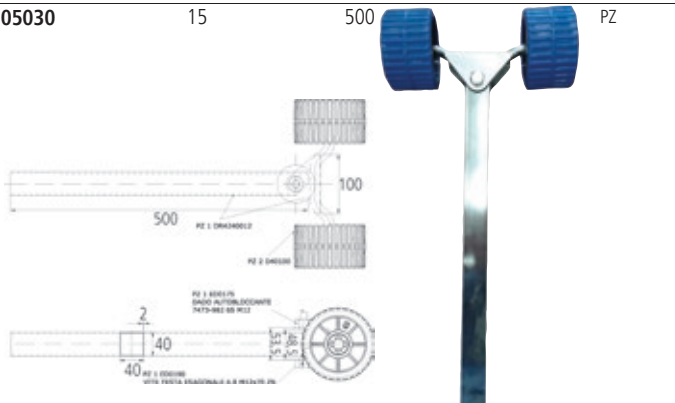

Cod.	ø mm Rullo	Altezza Staffa mm	UM	€
2805030	15	500	PZ	

**Staffa con Quattro Rulli Laterali Domar**

Staffa con perno mobile completa di quattro rulli laterali (2805010).



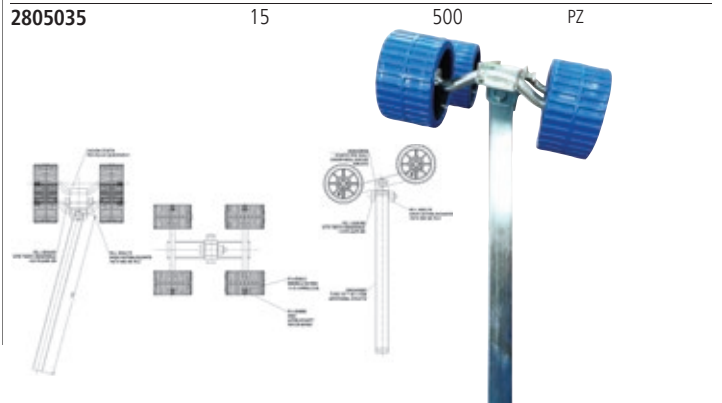

Cod.	ø mm Rullo	Altezza Staffa mm	UM	€
2805035	15	500	PZ	



Verricello di Alaggio Manuale

Verricello manuale per un facile alaggio dell'imbarcazione. Capacità Kg: peso limite che il verricello può sopportare su traino orizzontale con slittamento ottimale. Su traini inclinati si consiglia di non superare i due terzi del peso limite.

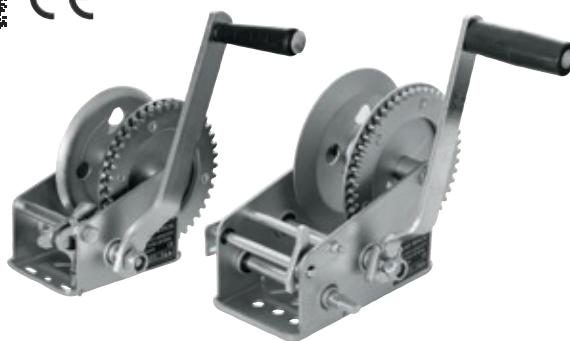

Cod.	Capacità Kg	n. Velocità	Dim mm	Per cavo	Per cinghia	UM	€
2810036	360	1	130 x 150 x H105	ø 4 mm	50 mm	PZ	
2810054 	540	1	138 x 240 x H134	ø 4 mm	50 mm	PZ	
2810063	640	1	185 x 130 x H150	ø 5 mm	50 mm	PZ	
2810125	900	2	250 x 150 x H170	ø 5 mm	50 mm	PZ	
2810126 	1100	2	330 x 162 x H193	ø 5 mm	50 mm	PZ	

**Cavi e Cinghie per Verricelli di Alaggio Manuali**

Cavi in Acciaio Zincato e cinghie in Nylon ad alta resistenza per verricelli di alaggio manuali. Completati di gancio terminale.



Cod.	Ref	Dim	Carico di Rottura Kg	UM	€
2810004	Cavo	ø 4 mm x 8 m	800	PZ	
2810005	Cavo	ø 5 mm x 10 m	1500	PZ	
2810014	Cinghia	50 mm x 8 m	1800	PZ	
2810015	Cinghia	50 mm x 10 m	1800	PZ	

**Verricello di Alaggio Manuale con Cavo**

Verricello manuale certificato CE in Acciaio Zincato per alaggio imbarcazioni. Completo di cavo da 10 metri e gancio. Capacità Kg: peso limite che il verricello può sopportare su traino orizzontale con slittamento ottimale. Su traini inclinati si consiglia di non superare i due terzi del peso limite.



Cod.	Capacità max Kg	Cavo ø mm	n. Velocità	Dim mm	UM	€
2810053	525	4	1	151 x 130 x H99	PZ	
2810083	825	5	1	205 x 129 x H155	PZ	

**Verricello Manuale HW Bada**

Verricello manuale in Acciaio verniciato per alaggio imbarcazioni. Completo di cavo da 7,6 metri e gancio. Capacità Kg: peso limite che il verricello può sopportare su traino orizzontale con slittamento ottimale. Su traini inclinati si consiglia di non superare i due terzi del peso limite.



Cod.	Capacità max Kg	Dim mm	UM	€
2810169	900	180 x 130 x H150	PZ	
2810171	1130	180 x 130 x H150	PZ	

**Verricello di Alaggio DW1 Bada**

Verricello elettrico per alaggio imbarcazioni e applicazione su fuoristrada. Alaggio e varo si effettuano elettricamente con pulsantiera cablata. Motore 12V a magneti permanenti da 0,8 kW con frizione per il rilascio manuale e sistema automatico di frenata. Montaggio con base e 2 viti M8. Velocità di recupero 4,2 m/min senza carico, 1,2 m/min a pieno carico.



Cod.	Trazione Max Kg	L cavo m	Dim mm	Peso Kg	UM	€
2820501	900	7,6	320 x 109 x H115	7,5	PZ	



Verricello di Alaggio DW3000 Bada

Verricello elettrico per alaggio imbarcazioni e applicazione su fuoristrada. Alaggio e varo si effettuano elettricamente con pulsantiera cablata. Motore 12V a magneti permanenti da 0,9 kW con frizione per il rilascio manuale e sistema automatico di frenata. Montaggio con base e 4 viti M8. Completo di passacavo a rulli che previene abrasioni.
Velocità di recupero 2,8 m/min senza carico, 0,6 m/min a pieno carico.



Cod.	Trazione Max Kg	L cavo m	Dim mm	Peso Kg	UM	€
2820506	1360	14	325 x 102 x H158	10	PZ	



BADA

CE

Verricello di Alaggio DW4000 Bada

Verricello elettrico per alaggio imbarcazioni e applicazione su fuoristrada. Alaggio e varo si effettuano elettricamente con pulsantiera cablata. Motore 12V a magneti permanenti da 1,3 kW con frizione per il rilascio manuale e sistema automatico di frenata. Montaggio con base e 4 viti M8. Completo di passacavo a rulli che previene abrasioni.
Velocità di recupero 4,8 m/min senza carico, 1,2 m/min a pieno carico.



Cod.	Trazione Max Kg	L cavo m	Dim mm	Peso Kg	UM	€
2820508	1810	12	333 x 115 x H116	12,5	PZ	



BADA

CE

Verricello di Alaggio DW4 Bada

Verricello elettrico con montaggio su base per alaggio imbarcazioni e applicazioni di recupero. Alaggio e varo si effettuano elettricamente con pulsantiera cablata oppure manualmente con manovella. Motore 12V a magneti permanenti da 0,48 kW con frizione per il rilascio manuale e sistema automatico di frenata. Velocità di recupero 1,8 m/min a pieno carico. Base montaggio 222 x 125 mm.



Cod.	Trazione Max Kg	L cavo m	Dim mm	Peso Kg	UM	€
2820503	1360	9	260 x 305 x H193	15	PZ	



BADA

CE

Verricello di Alaggio DW3D Bada

Verricello elettrico radiocomandato con montaggio su base per alaggio imbarcazioni e applicazioni di recupero. Alaggio e varo si effettuano elettricamente con pulsantiera wireless. Motore 12V a magneti permanenti da 0,3 kW con frizione per il rilascio manuale e sistema automatico di frenata. Velocità di recupero 1,8 m/min a pieno carico.



Cod.	Trazione Max Kg	L cavo m	Dim mm	Peso Kg	UM	€
2820509	900	9	240 x 254 x H190	11	PZ	



BADA

CE



MUSTO

Giacca Cerata Musto BR2 Offshore

Giacca cerata Musto BR2 Offshore realizzata con tessuto brevettato a 2 strati BR2 incredibilmente traspirante, impermeabile e antivento. Con maniche articolate, cappuccio fluorescente arrotolabile a scomparsa e regolabile in 2 direzioni, doppia patta frangivento con canale di drenaggio sopra la zip bidirezionale per una chiusura anteriore impenetrabile, collo foderato con pile a griglia per comodità e calore, doppi polsini con esterno regolabile, fodera in mesh, 2 tasche cargo con chiusure che deviano l'acqua, 4 tasche scaldamani parzialmente foderate in pile e una tasca interna con zip, tasca interna con zip per gli occhiali da sole, catarifrangenti a prisma e cuciture con strisce riflettenti.



Cod.	Taglia	Colore	UM	€
3050020	S	ROSSO	PZ	
3050021	M	ROSSO	PZ	
3050022	L	ROSSO	PZ	
3050023	XL	ROSSO	PZ	
3050024	2XL	ROSSO	PZ	
3050030	S	NERO	PZ	
3050031	M	NERO	PZ	
3050032	L	NERO	PZ	
3050033	XL	NERO	PZ	
3050034	2XL	NERO	PZ	

Salopette Musto BR2 Offshore

Salopette Musto BR2 Offshore realizzati con il tessuto brevettato a 2 strati BR2 incredibilmente traspirante, impermeabile e antivento. Struttura con cuciture impermeabili interamente nastrate, vita alta per una maggiore protezione, girovita regolabile sul retro, bretelle e inserti sotto le braccia elasticizzati. Con tasca multiuso rimovibile, bretelle ricoperte di tessuto e regolabili con Velcro, zip anteriore bidirezionale con soffietto per un accesso facilitato, caviglie regolabili con chiusura in Velcro, tasca cargo sulla coscia con chiusura idrorepellente, ginocchia e fondoschiena rinforzati.

MUSTO



Cod.	Taglia	Colore	UM	€
3050040	S	ROSSO	PZ	
3050041	M	ROSSO	PZ	
3050042	L	ROSSO	PZ	
3050043	XL	ROSSO	PZ	
3050044	2XL	ROSSO	PZ	
3050050	S	NERO	PZ	
3050051	M	NERO	PZ	
3050052	L	NERO	PZ	
3050053	XL	NERO	PZ	
3050054	2XL	NERO	PZ	



7 SICUREZZA SPORT/ABBIGLIAMENTO/BATTELLI ALAGGIO

Giacca Cerata Musto BR1 Channel

Giacca cerata Musto BR1 Channel Offshore a 3 strati fornisce un livello superiore di protezione impermeabile e antivento. Con cuciture termosaldate, polsini regolabili, fodera con pannelli in rete ad asciugatura rapida, patta antivento, alto colletto protettivo in pile, tasca esterna con zip, cordino regolabile sull'orlo, anello a D per cordino, cappuccio tecnico a scomparsa in tessuto ad alta visibilità ed elementi riflettenti.

MUSTO



Cod.	Taglia	Colore	UM	€
3050070	S	ROSSO	PZ	
3050071	M	ROSSO	PZ	
3050072	L	ROSSO	PZ	
3050073	XL	ROSSO	PZ	
3050074	2XL	ROSSO	PZ	
3050080	S	NERO	PZ	
3050081	M	NERO	PZ	
3050082	L	NERO	PZ	
3050083	XL	NERO	PZ	
3050084	2XL	NERO	PZ	



Salopette Musto BR1 Channel Offshore

Salopette Musto BR1 Channel Offshore a 3 strati fornisce un livello superiore di protezione impermeabile e antivento. Con cuciture termosaldate, fodera con pannelli in rete ad asciugatura rapida, rinforzi sulla seduta e sulle ginocchia, schiena alta con bretelle regolabili, vita regolabile, tasca cargo, aperture per le gambe regolabili, seduta e ginocchia preformate.

MUSTO



Cod.	Taglia	Colore	UM	€
3050090	S	NERO	PZ	
3050091	M	NERO	PZ	
3050092	L	NERO	PZ	
3050093	XL	NERO	PZ	
3050094	2XL	NERO	PZ	

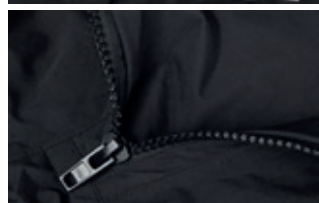

Giacca Musto Essential Softshell

Giacca Musto Essential Softshell in tessuto softshell elasticizzato traspirante e antivento. Con trattamento idrorepellente DWR (Durable Water Repellency), due tasche laterali e una sul braccio con chiusura a zip, orlo e polsini con bordo elasticizzato per una vestibilità aderente e maniche articolate per la massima libertà di movimento.

MUSTO

Cod.	Taglia	Colore	UM	€
3050100	S	BLUE NAVY	PZ	
3050101	M	BLUE NAVY	PZ	
3050102	L	BLUE NAVY	PZ	
3050103	XL	BLUE NAVY	PZ	
3050104	2XL	BLUE NAVY	PZ	
3050110	S	PLATINO	PZ	
3050111	M	PLATINO	PZ	
3050112	L	PLATINO	PZ	
3050113	XL	PLATINO	PZ	
3050114	2XL	PLATINO	PZ	
3050120	S	NERO	PZ	
3050121	M	NERO	PZ	
3050122	L	NERO	PZ	
3050123	XL	NERO	PZ	
3050124	2XL	NERO	PZ	



Gilet Musto Essential Softshell

Gilet Musto Essential Softshell in tessuto softshell elasticizzato traspirante e antivento. Con trattamento idrorepellente DWR (Durable Water Repellency), due tasche laterali e una sul petto con chiusura a zip e orlo con bordo elasticizzato per una vestibilità aderente.

MUSTO

Cod.	Taglia	Colore	UM	€
3050130	S	BLUE NAVY	PZ	
3050131	M	BLUE NAVY	PZ	
3050132	L	BLUE NAVY	PZ	
3050133	XL	BLUE NAVY	PZ	
3050134	2XL	BLUE NAVY	PZ	
3050140	S	PLATINO	PZ	
3050141	M	PLATINO	PZ	
3050142	L	PLATINO	PZ	
3050143	XL	PLATINO	PZ	
3050144	2XL	PLATINO	PZ	
3050150	S	NERO	PZ	
3050151	M	NERO	PZ	
3050152	L	NERO	PZ	
3050153	XL	NERO	PZ	
3050154	2XL	NERO	PZ	



7 SICUREZZA SPORT/ABBIGLIAMENTO/BATTELLI ALAGGIO

Polo Musto Evolution Sunblock 2.0

Polo Musto Evolution Sunblock presenta una straordinaria struttura in poliestere e elastene UPF40 per la massima protezione in caso di forte esposizione al sole. Le cuciture piatte sono appena rilevabili sulla pelle per il massimo comfort.

MUSTO

Cod.	Taglia	Colore	UM	€
3050600	S	BIANCO	PZ	
3050601	M	BIANCO	PZ	
3050602	L	BIANCO	PZ	
3050603	XL	BIANCO	PZ	
3050604	2XL	BIANCO	PZ	
3050610	S	BLUE NAVY	PZ	
3050611	M	BLUE NAVY	PZ	
3050612	L	BLUE NAVY	PZ	
3050613	XL	BLUE NAVY	PZ	
3050614	2XL	BLUE NAVY	PZ	
3050620	S	PLATINO	PZ	
3050621	M	PLATINO	PZ	
3050622	L	PLATINO	PZ	
3050623	XL	PLATINO	PZ	
3050624	2XL	PLATINO	PZ	
3050630	S	NERO	PZ	
3050631	M	NERO	PZ	
3050632	L	NERO	PZ	
3050633	XL	NERO	PZ	
3050634	2XL	NERO	PZ	



T-Shirt Musto Evolution Sunblock 2.0

T-Shirt Musto Evolution Sunblock presenta una straordinaria struttura in poliestere e elastene UPF40 per la massima protezione in caso di forte esposizione al sole. Le cuciture piatte sono appena rilevabili sulla pelle per il massimo comfort.

MUSTO

Cod.	Taglia	Colore	UM	€
3050640	S	BIANCO	PZ	
3050641	M	BIANCO	PZ	
3050642	L	BIANCO	PZ	
3050643	XL	BIANCO	PZ	
3050644	2XL	BIANCO	PZ	
3050650	S	BLUE NAVY	PZ	
3050651	M	BLUE NAVY	PZ	
3050652	L	BLUE NAVY	PZ	
3050653	XL	BLUE NAVY	PZ	
3050654	2XL	BLUE NAVY	PZ	
3050660	S	PLATINO	PZ	
3050661	M	PLATINO	PZ	
3050662	L	PLATINO	PZ	
3050663	XL	PLATINO	PZ	
3050664	2XL	PLATINO	PZ	



Shorts Musto Evo Performance 2.0

Pantaloncini da vela Musto Evo Performance resistenti e performanti in tessuto elasticizzato leggero e ad asciugatura rapida che offre piena libertà di movimento e comfort. Con seduta rinforzata, cintura regolabile, chiusura con zip e bottone, due tasche laterali con zip resistente all'acqua e una tasca posteriore con chiusura a strappo. Protezione UPF40+ da raggi UV.

MUSTO

Cod.	Taglia	Colore	UM	€
3050700	46 (30)	NERO	PZ	
3050701	48 (32)	NERO	PZ	
3050702	50 (34)	NERO	PZ	
3050703	52 (36)	NERO	PZ	
3050704	54 (38)	NERO	PZ	
3050705	56 (40)	NERO	PZ	
3050710	46 (30)	PLATINO	PZ	
3050711	48 (32)	PLATINO	PZ	
3050712	50 (34)	PLATINO	PZ	
3050713	52 (36)	PLATINO	PZ	
3050714	54 (38)	PLATINO	PZ	
3050715	56 (40)	PLATINO	PZ	



Guanti Musto Essential Sailing

Guanti da vela Musto Essential Sailing dalla struttura in mesh dinamica elasticizzata in 4 direzioni che garantisce traspirabilità, una comoda vestibilità anatomica e la piena libertà di movimento. I pannelli di protezione strategici offrono resistenza, mentre le ampie chiusure in Velcro sul polso trattengono il calore e consentono di avere una vestibilità personalizzata.



MUSTO

Cod.	L dita	Taglia	UM	€
3050340	3/4	XS	PZ	
3050341	3/4	S	PZ	
3050342	3/4	M	PZ	
3050343	3/4	L	PZ	
3050344	3/4	XL	PZ	
3050345	3/4	2XL	PZ	
3050330	Intere	XS	PZ	
3050331	Intere	S	PZ	
3050332	Intere	M	PZ	
3050333	Intere	L	PZ	
3050334	Intere	XL	PZ	
3050335	Intere	2XL	PZ	



Guanti Musto Performance

Musto Guanti Performance di qualità superiore con struttura leggera in mesh dinamica elasticizzata in 4 direzioni che offre traspirabilità, una comoda vestibilità anatomica e una grande libertà di movimento. Il sistema Dynamic Fit permette la piena motilità delle nocche e il massimo comfort. Il palmo in GripFlex garantisce una presa salda e una copertura superiore del polso.



MUSTO

Cod.	L dita	Taglia	UM	€
3050320	3/4	XS	PZ	
3050321	3/4	S	PZ	
3050322	3/4	M	PZ	
3050323	3/4	L	PZ	
3050324	3/4	XL	PZ	
3050325	3/4	2XL	PZ	
3050310	Intere	XS	PZ	
3050311	Intere	S	PZ	
3050312	Intere	M	PZ	
3050313	Intere	L	PZ	
3050314	Intere	XL	PZ	
3050315	Intere	2XL	PZ	



Guanti Musto Performance Winter

Musto Guanti Invernali Performance dal design ergonomico per offrire maggiore comodità e destrezza. Realizzati in Neoprene di alta qualità garantiscono un'ottima presa e protezione dal freddo. I rinforzi su dita e palmi minimizzano le irritazioni dovute all'attrito con la corda. Sono flessibili anche da asciutti con vestibilità impeccabile grazie alla linguetta ai polsini.



MUSTO

Cod.	L dita	Taglia	UM	€
3050300	Intere	XS	PZ	
3050301	Intere	S	PZ	
3050302	Intere	M	PZ	
3050303	Intere	L	PZ	
3050304	Intere	XL	PZ	
3050305	Intere	2XL	PZ	



7 SICUREZZA SPORT/ABBIGLIAMENTO/BATTELLI ALAGGIO

Cappello Musto Evolution FD Brimmed

Cappello Musto Evolution Fast Dry Brimmed con rivestimento idrorepellente a lunga durata (DWR) per favorire la fuoriuscita dell'acqua per tempi di asciugatura più rapidi, fattore di protezione dai raggi ultravioletti UPF40, coulisse regolabile che lo mantiene al sicuro dal vento e chiusura a bottone per sollevare la tesa all'occorrenza.



MUSTO

Cod.	Taglia	Colore	UM	€
3050410	S	BEIGE	PZ	
3050411	M	BEIGE	PZ	
3050412	L	BEIGE	PZ	
3050413	S	BLUE NAVY	PZ	
3050414	M	BLUE NAVY	PZ	
3050415	L	BLUE NAVY	PZ	
3050416	S	BIANCO	PZ	
3050417	M	BIANCO	PZ	
3050418	L	BIANCO	PZ	



Borsa Musto Evolution Dry Tube

Borsa Musto Evolution Dry Tube a tenuta stagna che si chiude con una fibbia che può essere utilizzata come maniglia. Con finestra traslucida nella parte anteriore per aiutare a localizzare gli effetti personali e tracolla removibile per un facile trasporto.



MUSTO

Cod.	Capacità Lt	Dim cm	Colore	UM	€
3050450	1,5	ø 23 x H30	PLATINO	PZ	
3050451	1,5	ø 23 x H30	NERO	PZ	
3050452	10	ø 19 x H38	PLATINO	PZ	
3050453	10	ø 19 x H38	NERO	PZ	
3050454	20	ø 24 x H40	PLATINO	PZ	
3050455	20	ø 24 x H40	NERO	PZ	



Scarpa Musto Dynamic Pro II Adapt

Scarpa da vela Musto Dynamic Pro II Adapt costruita in rete a strato singolo ad asciugatura rapida, con tecnologia di drenaggio dell'acqua XPL per evitare ristagni nella scarpa, suola multidirezionale Grip Flex per una presa eccezionale su superfici bagnate, suola Grip Deck con mescola di gomma adesiva per una presa sicura, tallone ammortizzante e sistema di allacciatura dinamica Gilly che fornisce una chiusura sicura e confortevole.



MUSTO

Cod.	Numero	Colore	UM	€
3050500	40,5 (7,5)	PLATINUM / GOLD	CP	
3050501	41 (8)	PLATINUM / GOLD	CP	
3050502	42 (8,5)	PLATINUM / GOLD	CP	
3050503	42,5 (9)	PLATINUM / GOLD	CP	
3050504	43 (9,5)	PLATINUM / GOLD	CP	
3050505	44 (10)	PLATINUM / GOLD	CP	
3050506	44,5 (10,5)	PLATINUM / GOLD	CP	
3050507	45 (11)	PLATINUM / GOLD	CP	
3050508	46 (11,5)	PLATINUM / GOLD	CP	



Giacca Cearata HH Skagen Offshore Jacket

Giacca Helly Hansen Skagen Offshore Jacket realizzata per la navigazione offshore e costiera con protezione totale dal vento e dalle onde. Con tessuto impermeabile, antivento e traspirante HellyTech® Performance a 2 strati con trattamento idrorepellente DWR (Durable Water Repellency). Cuciture completamente sigillate, fodera in mesh ad asciugatura rapida, rinforzo lombare, doppia patta antivento, doppi polsini regolabili, maniche preformate, tasche sul petto con zip resistente all'acqua, tasche scaldamani foderate in pile, grandi tasche cargo, collo alto profilato e maschera per il viso, cappuccio regolabile in tessuto ad alta visibilità EN471 ed elementi riflettenti a norme Solas.



Cod.	Taglia	Colore	UM	€
3041710	S	BLUE NAVY	PZ	
3041711	M	BLUE NAVY	PZ	
3041712	L	BLUE NAVY	PZ	
3041713	XL	BLUE NAVY	PZ	
3041714	2XL	BLUE NAVY	PZ	
3041740	S	ROSSO	PZ	
3041741	M	ROSSO	PZ	
3041742	L	ROSSO	PZ	
3041743	XL	ROSSO	PZ	
3041744	2XL	ROSSO	PZ	



Salopette HH Skagen Offshore

Salopette Helly Hansen Skagen Offshore Jacket realizzate per la navigazione offshore e costiera con protezione totale dal vento e dalle onde. Con tessuto impermeabile, antivento e traspirante HellyTech® Performance a 2 strati con trattamento idrorepellente DWR (Durable Water Repellency). Cuciture completamente sigillate, fodera a rete ad asciugatura rapida all'interno, rinforzi per sedile e ginocchia, schienale alto per una protezione maggiore, zip bidirezionale sul davanti, bretelle e vita regolabili, tasca cargo destra con zip idrorepellente, tasca cargo a sinistra, apertura per le gambe regolabili, seduta e ginocchia preformate.



Cod.	Taglia	Colore	UM	€
3041720	S	EBANO	PZ	
3041721	M	EBANO	PZ	
3041722	L	EBANO	PZ	
3041723	XL	EBANO	PZ	
3041724	2XL	EBANO	PZ	



7 SICUREZZA SPORT/ABBIGLIAMENTO/BATTELLI ALAGGIO

Giacca Cerata HH Pier 3.0 Jacket

Giacca Helly Hansen Pier 3.0 Jacket ideale per tutte le attività in barca e costiere. Con tessuto impermeabile, antivento e traspirante HellyTech Performance a 2 strati con trattamento idrorepellente DWR (Durable Water Repellency). Con cuciture termosaldate, fodera con pannelli in rete ad asciugatura rapida, patta antivento, vita e fondo giacca regolabili, doppi polsini regolabili, tasche scaldamani, maniche preformate, alto colletto protettivo in pile, cappuccio regolabile in tessuto ad alta visibilità EN471 ed elementi riflettenti a norme Solas.



Cod.	Taglia	Colore	UM	€
3040021	S	BLUE NAVY	PZ	
3040022	M	BLUE NAVY	PZ	
3040023	L	BLUE NAVY	PZ	
3040024	XL	BLUE NAVY	PZ	
3040025	2XL	BLUE NAVY	PZ	
3040026	S	ROSSO	PZ	
3040027	M	ROSSO	PZ	
3040028	L	ROSSO	PZ	
3040029	XL	ROSSO	PZ	
3040030	2XL	ROSSO	PZ	



Salopette HH Pier 3.0 Pant

Salopette Helly Hansen Pier 3.0 Pant ideali per tutte le attività in barca e costiere. Con tessuto impermeabile, antivento e traspirante HellyTech Performance a 2 strati con trattamento idrorepellente DWR (Durable Water Repellency). Con cuciture termosaldate, fodera con pannelli in rete ad asciugatura rapida, rinforzi sulla seduta e sulle ginocchia, schiena alta con bretelle regolabili, vita regolabile, zip bidirezionale sul davanti, tasca cargo, aperture per le gambe regolabili, seduta e ginocchia preformate.



Cod.	Taglia	Colore	UM	€
3040035	S	BLUE NAVY	PZ	
3040036	M	BLUE NAVY	PZ	
3040037	L	BLUE NAVY	PZ	
3040038	XL	BLUE NAVY	PZ	
3040039	2XL	BLUE NAVY	PZ	
3040041	S	GRIGIO EBANO	PZ	
3040042	M	GRIGIO EBANO	PZ	
3040043	L	GRIGIO EBANO	PZ	
3040044	XL	GRIGIO EBANO	PZ	
3040045	2XL	GRIGIO EBANO	PZ	



Giacca Cerata HH Pier 3.0 Jacket Donna

Giacca Helly Hansen Pier 3.0 Jacket ideale per tutte le attività in barca e costiere. Con tessuto impermeabile, antivento e traspirante HellyTech Performance a 2 strati con trattamento idrorepellente DWR (Durable Water Repellency). Con cuciture termosaldate, fodera con pannelli in rete ad asciugatura rapida, patta antivento, vita e fondo giacca regolabili, doppi polsini regolabili, tasche scaldamani, maniche preformate, alto colletto protettivo in pile, cappuccio regolabile in tessuto ad alta visibilità EN471 ed elementi riflettenti a norme Solas.



Cod.	Taglia	Colore	UM	€
3040051	XS	BLUE NAVY	PZ	
3040052	S	BLUE NAVY	PZ	
3040053	M	BLUE NAVY	PZ	
3040054	L	BLUE NAVY	PZ	
3040055	XS	ROSSO	PZ	
3040056	S	ROSSO	PZ	
3040057	M	ROSSO	PZ	
3040058	L	ROSSO	PZ	



Salopette HH Pier 3.0 Pant Donna

Salopette Helly Hansen Pier 3.0 Pant ideali per tutte le attività in barca e costiere. Con tessuto impermeabile, antivento e traspirante HellyTech Performance a 2 strati con trattamento idrorepellente DWR (Durable Water Repellency). Con cuciture termosaldate, fodera con pannelli in rete ad asciugatura rapida, rinforzi sulla seduta e sulle ginocchia, schiena alta con bretelle regolabili, vita regolabile, zip bidirezionale sul davanti, tasca cargo, aperture per le gambe regolabili, seduta e ginocchia preformate.



Cod.	Taglia	Colore	UM	€
3040090	XS	BLUE NAVY	PZ	
3040091	S	BLUE NAVY	PZ	
3040092	M	BLUE NAVY	PZ	
3040093	L	BLUE NAVY	PZ	
3040095	XS	GRIGIO EBANO	PZ	
3040096	S	GRIGIO EBANO	PZ	
3040097	M	GRIGIO EBANO	PZ	
3040098	L	GRIGIO EBANO	PZ	



7 SICUREZZA SPORT/ABBIGLIAMENTO/BATTELLI ALAGGIO



HH Crew Midlayer Jacket

Giacca Helly Hansen Crew Midlayer Jacket ideale per proteggersi dal freddo in barca e in città. Tessuto impermeabile, antivento e traspirante HellyTech Protection a 2 strati con trattamento idrorepellente DWR (Durable Water Repellency). Con cuciture termosaldate, fodera ad asciugatura rapida, isolamento con fodera in pile Polartec® da 100g, tasche scaldamani, polsini e fondo giacca regolabili.



Cod.	Taglia	Colore	UM	€
3040001	S	BLUE NAVY	PZ	
3040002	M	BLUE NAVY	PZ	
3040003	L	BLUE NAVY	PZ	
3040004	XL	BLUE NAVY	PZ	
3040005	2XL	BLUE NAVY	PZ	
3040006	3XL	BLUE NAVY	PZ	
3040101	S	NERO	PZ	
3040102	M	NERO	PZ	
3040103	L	NERO	PZ	
3040104	XL	NERO	PZ	
3040105	2XL	NERO	PZ	
3040106	3XL	NERO	PZ	
3040195	S	GRIGIO	PZ	
3040196	M	GRIGIO	PZ	
3040197	L	GRIGIO	PZ	
3040198	XL	GRIGIO	PZ	
3040199	2XL	GRIGIO	PZ	



HH Crew Midlayer Jacket Donna

Giacca Helly Hansen Crew Midlayer Jacket ideale per proteggersi dal freddo in barca e in città. Tessuto impermeabile, antivento e traspirante HellyTech Protection a 2 strati con trattamento idrorepellente DWR (Durable Water Repellency). Con cuciture termosaldate, fodera ad asciugatura rapida, isolamento con fodera in pile Polartec® da 100g, tasche scaldamani, colletto foderato in pile con cappuccio ripiegabile, polsini e fondo giacca regolabili.



Cod.	Taglia	Colore	UM	€
3040070	XS	BLUE NAVY	PZ	
3040071	S	BLUE NAVY	PZ	
3040072	M	BLUE NAVY	PZ	
3040073	L	BLUE NAVY	PZ	
3040074	XL	BLUE NAVY	PZ	
3040060	XS	BIANCO	PZ	
3040061	S	BIANCO	PZ	
3040062	M	BIANCO	PZ	
3040063	L	BIANCO	PZ	
3040064	XL	BIANCO	PZ	



HH Crew Jacket

Versatile Giacca Helly Hansen Crew Jacket che garantisce una protezione totale dall'acqua e dal vento. Tessuto impermeabile, antivento e traspirante HellyTech Protection a 2 strati con trattamento idrorepellente DWR (Durable Water Repellency). Con cuciture termosaldate, fodera ad asciugatura rapida, tasche con zip e polsini regolabili.

Cod.	Taglia	Colore	UM
3040121	S	BLUE NAVY	PZ
3040122	M	BLUE NAVY	PZ
3040123	L	BLUE NAVY	PZ
3040124	XL	BLUE NAVY	PZ
3040125	2XL	BLUE NAVY	PZ
3040126	3XL	BLUE NAVY	PZ
3041100	S	GRIGIO	PZ
3041101	M	GRIGIO	PZ
3041102	L	GRIGIO	PZ
3041103	XL	GRIGIO	PZ
3041104	2XL	GRIGIO	PZ
3041105	3XL	GRIGIO	PZ
3041150	S	NERO	PZ
3041151	M	NERO	PZ
3041152	L	NERO	PZ
3041153	XL	NERO	PZ
3041154	2XL	NERO	PZ
3041155	3XL	NERO	PZ



HH Crew Jacket Donna

Versatile Giacca Helly Hansen Crew Jacket che garantisce una protezione totale dall'acqua e dal vento. Tessuto impermeabile, antivento e traspirante HellyTech Protection a 2 strati con trattamento idrorepellente DWR (Durable Water Repellency). Con cuciture termosaldate, fodera ad asciugatura rapida, tasche con zip e polsini regolabili.

Cod.	Taglia	Colore	UM	€
3040740	XS	BLUE NAVY	PZ	
3040741	S	BLUE NAVY	PZ	
3040742	M	BLUE NAVY	PZ	
3040743	L	BLUE NAVY	PZ	
3040744	XL	BLUE NAVY	PZ	
3040750	XS	BIANCO	PZ	
3040751	S	BIANCO	PZ	
3040752	M	BIANCO	PZ	
3040753	L	BIANCO	PZ	
3040754	XL	BIANCO	PZ	
3040755	XS	GRIGIO	PZ	
3040756	S	GRIGIO	PZ	
3040757	M	GRIGIO	PZ	
3040758	L	GRIGIO	PZ	
3040759	XL	GRIGIO	PZ	



SICUREZZA SPORT/ABBIGLIAMENTO/BATTELLI ALAGGIO

7



HH Crew Vest

Gilet smanicato Helly Hansen Crew Vest per i giorni di vento o per le fresche giornate estive. Tessuto impermeabile, antivento e traspirante HellyTech Protection a 2 strati con trattamento idrorepellente DWR (Durable Water Repellency).

Cuciture termosaldate, fodera ad asciugatura rapida, tasche sul petto con zip e fondo giacca regolabile.

Cod.	Taglia	Colore	UM	€
3040141	S	BLUE NAVY	PZ	
3040142	M	BLUE NAVY	PZ	
3040143	L	BLUE NAVY	PZ	
3040144	XL	BLUE NAVY	PZ	
3040145	2XL	BLUE NAVY	PZ	
3040146	3XL	BLUE NAVY	PZ	
3041650	S	BIANCO	PZ	
3041651	M	BIANCO	PZ	
3041652	L	BIANCO	PZ	
3041653	XL	BIANCO	PZ	
3041654	2XL	BIANCO	PZ	
3041655	3XL	BIANCO	PZ	
3041160	S	NERO	PZ	
3041161	M	NERO	PZ	
3041162	L	NERO	PZ	
3041163	XL	NERO	PZ	
3041164	2XL	NERO	PZ	
3041165	3XL	NERO	PZ	



HH Crew Vest Donna

Gilet smanicato Helly Hansen Crew Vest per i giorni di vento o per le fresche giornate estive. Tessuto impermeabile, antivento e traspirante HellyTech Protection a 2 strati con trattamento idrorepellente DWR (Durable Water Repellency).

Con cuciture termosaldate, fodera ad asciugatura rapida, tasche sul petto con zip e fondo giacca regolabile.

Cod.	Taglia	Colore	UM	€
3040080	XS	BLUE NAVY	PZ	
3040081	S	BLUE NAVY	PZ	
3040082	M	BLUE NAVY	PZ	
3040083	L	BLUE NAVY	PZ	
3040084	XL	BLUE NAVY	PZ	
3040510	XS	BIANCO	PZ	
3040511	S	BIANCO	PZ	
3040512	M	BIANCO	PZ	
3040513	L	BIANCO	PZ	
3040514	XL	BIANCO	PZ	



HH Daybreaker Fleece Jacket

Versatile Giacca Helly Hansen Daybreaker Fleece Jacket ideale per proteggersi dal freddo in barca e in città. Tessuto in pile Polartec® 100gr elasticizzato caldo, comodo e traspirante. Tasche con zip frontali e cuciture piatte

Cod.	Taglia	Colore	UM	€
3040415	S	BLUE NAVY	PZ	
3040416	M	BLUE NAVY	PZ	
3040417	L	BLUE NAVY	PZ	
3040418	XL	BLUE NAVY	PZ	
3040419	2XL	BLUE NAVY	PZ	
3040410	S	NERO	PZ	
3040411	M	NERO	PZ	
3040412	L	NERO	PZ	
3040413	XL	NERO	PZ	
3040414	2XL	NERO	PZ	



Pantalone HH QD Cargo

Pantalone Helly Hansen QD Cargo con resistente tessuto 140 g/m² in Poliammide elasticizzato antistrappo, leggero e ad asciugatura rapida. Con tasche posteriori, tasche frontali, tasche cargo, patta anteriore con zip e passanti per cintura.



Cod.	Taglia	Colore	UM	€
3040945	46 (30)	BLUE NAVY	PZ	
3040946	48 (32)	BLUE NAVY	PZ	
3040947	49 (33)	BLUE NAVY	PZ	
3040948	50 (34)	BLUE NAVY	PZ	
3040949	52 (36)	BLUE NAVY	PZ	
3040950	54 (38)	BLUE NAVY	PZ	
3040952	46 (30)	GRIGIO EBANO	PZ	
3040953	48 (32)	GRIGIO EBANO	PZ	
3040954	49 (33)	GRIGIO EBANO	PZ	
3040955	50 (34)	GRIGIO EBANO	PZ	
3040956	52 (36)	GRIGIO EBANO	PZ	
3040957	54 (38)	GRIGIO EBANO	PZ	



Shorts HH QD Cargo

Pantaloncini Helly Hansen QD Cargo Shorts con resistente tessuto 140 g/m² in Poliammide elasticizzato antistrappo e ad asciugatura rapida. Con tasca posteriore a zip, due tasche frontali, due tasche cargo, patta anteriore con zip e protezione UPF40+ da raggi UV.

Cod.	Taglia	Colore	UM	€
3040960	46 (30)	BLUE NAVY	PZ	
3040961	48 (32)	BLUE NAVY	PZ	
3040962	49 (33)	BLUE NAVY	PZ	
3040963	50 (34)	BLUE NAVY	PZ	
3040964	52 (36)	BLUE NAVY	PZ	
3040965	54 (38)	BLUE NAVY	PZ	
3040967	46 (30)	GRIGIO CHIARO	PZ	
3040968	48 (32)	GRIGIO CHIARO	PZ	
3040969	49 (33)	GRIGIO CHIARO	PZ	
3040970	50 (34)	GRIGIO CHIARO	PZ	
3040971	52 (36)	GRIGIO CHIARO	PZ	
3040972	54 (38)	GRIGIO CHIARO	PZ	
3040974	46 (30)	GRIGIO EBANO	PZ	
3040975	48 (32)	GRIGIO EBANO	PZ	
3040976	49 (33)	GRIGIO EBANO	PZ	
3040977	50 (34)	GRIGIO EBANO	PZ	
3040978	52 (36)	GRIGIO EBANO	PZ	
3040979	54 (38)	GRIGIO EBANO	PZ	
3040980	46 (30)	SABBIA	PZ	
3040981	48 (32)	SABBIA	PZ	



Cod.	Taglia	Colore	UM	€
3040982	49 (33)	SABBIA	PZ	
3040983	50 (34)	SABBIA	PZ	
3040984	52 (36)	SABBIA	PZ	
3040985	54 (38)	SABBIA	PZ	

Shorts HH QD Cargo Donna

Pantaloncini Helly Hansen QD Cargo Shorts con resistente tessuto 140 g/m² in Poliammide elasticizzato antistrappo e ad asciugatura rapida. Con tasca posteriore a zip, due tasche frontali, tasca cargo, patta anteriore con zip e protezione UPF40+ da raggi UV.

Cod.	Taglia	Colore	UM	€
3040920	42 (28)	BLUE NAVY	PZ	
3040921	43 (29)	BLUE NAVY	PZ	
3040922	44 (30)	BLUE NAVY	PZ	
3040923	45 (31)	BLUE NAVY	PZ	
3040924	46 (32)	BLUE NAVY	PZ	
3040925	48 (34)	BLUE NAVY	PZ	
3040930	42 (28)	GRIGIO CHIARO	PZ	
3040931	43 (29)	GRIGIO CHIARO	PZ	
3040932	44 (30)	GRIGIO CHIARO	PZ	
3040933	45 (31)	GRIGIO CHIARO	PZ	
3040934	46 (32)	GRIGIO CHIARO	PZ	
3040935	48 (34)	GRIGIO CHIARO	PZ	
3040937	42 (28)	GRIGIO EBANO	PZ	
3040938	43 (29)	GRIGIO EBANO	PZ	
3040939	44 (30)	GRIGIO EBANO	PZ	
3040940	45 (31)	GRIGIO EBANO	PZ	
3040941	46 (32)	GRIGIO EBANO	PZ	
3040942	48 (34)	GRIGIO EBANO	PZ	



7 SICUREZZA SPORT/ABBIGLIAMENTO/BATELLI ALAGGIO



Pantalone HH Racing Deck

Pantalone Helly Hansen HP Racing Deck con tessuto professionale da regata 510 g/m² in Poliammide elasticizzato, comodo, antistrappo e ad asciugatura rapida. Con seduta e ginocchia rinforzate in Nylon Oxford, due tasche diagonali sui fianchi con chiusura zip e dettagli in cuciture saldate.



Cod.	Taglia	Colore	UM	€
3040433N	44 (28)	BLUE NAVY	PZ	
3040434N	46 (30)	BLUE NAVY	PZ	
3040435N	48 (32)	BLUE NAVY	PZ	
3040436N	49 (33)	BLUE NAVY	PZ	
3040437N	50 (34)	BLUE NAVY	PZ	
3040438N	52 (36)	BLUE NAVY	PZ	
3040439N	54 (38)	BLUE NAVY	PZ	
3040433G	44 (28)	GRIGIO CHIARO	PZ	
3040434G	46 (30)	GRIGIO CHIARO	PZ	
3040435G	48 (32)	GRIGIO CHIARO	PZ	
3040436G	49 (33)	GRIGIO CHIARO	PZ	
3040437G	50 (34)	GRIGIO CHIARO	PZ	
3040438G	52 (36)	GRIGIO CHIARO	PZ	
3040439G	54 (38)	GRIGIO CHIARO	PZ	



Shorts HH Racing Deck

Pantaloncini Helly Hansen HP Racing Deck con tessuto professionale da regata 340 g/m² in Poliammide elasticizzato, comodo, antistrappo e ad asciugatura rapida. Con seduta rinforzata in Nylon Oxford, due tasche diagonali sui fianchi con chiusura zip e dettagli in cuciture saldate.



Cod.	Taglia	Colore	UM	€
3040426N	44 (28)	BLUE NAVY	PZ	
3040427N	46 (30)	BLUE NAVY	PZ	
3040428N	48 (32)	BLUE NAVY	PZ	
3040429N	49 (33)	BLUE NAVY	PZ	
3040430N	50 (34)	BLUE NAVY	PZ	
3040431N	52 (36)	BLUE NAVY	PZ	
3040432N	54 (38)	BLUE NAVY	PZ	
3040426G	44 (28)	GRIGIO CHIARO	PZ	
3040427G	46 (30)	GRIGIO CHIARO	PZ	
3040428G	48 (32)	GRIGIO CHIARO	PZ	
3040429G	49 (33)	GRIGIO CHIARO	PZ	
3040430G	50 (34)	GRIGIO CHIARO	PZ	
3040431G	52 (36)	GRIGIO CHIARO	PZ	
3040432G	54 (38)	GRIGIO CHIARO	PZ	



Maglia HH Tech Crew

Maglia a manica lunga Helly Hansen Tech Crew ideale per molteplici attività sportive. Tessuto tecnico leggero in Poliestere 140 g/m² ad asciugatura rapida, traspirante, soffice e comodo sulla pelle. Cuciture piatte.



Cod.	Taglia	Colore	UM	€
3040251	S	BIANCO	PZ	
3040252	M	BIANCO	PZ	
3040253	L	BIANCO	PZ	
3040254	XL	BIANCO	PZ	
3040255	2XL	BIANCO	PZ	
3040246	S	GRIGIO CHIARO	PZ	
3040247	M	GRIGIO CHIARO	PZ	
3040248	L	GRIGIO CHIARO	PZ	
3040249	XL	GRIGIO CHIARO	PZ	
3040250	2XL	GRIGIO CHIARO	PZ	



Maglia HH Tech Crew Donna

Maglia a manica lunga Helly Hansen Tech Crew ideale per molteplici attività sportive. Tessuto tecnico leggero in Poliestere 140 g/m² ad asciugatura rapida, traspirante, soffice e comodo sulla pelle. Cuciture piatte.



Cod.	Taglia	Colore	UM	€
3040295	XS	BIANCO	PZ	
3040296	S	BIANCO	PZ	
3040297	M	BIANCO	PZ	
3040298	L	BIANCO	PZ	
3041220	XS	GRIGIO CHIARO	PZ	
3041221	S	GRIGIO CHIARO	PZ	
3041222	M	GRIGIO CHIARO	PZ	
3041223	L	GRIGIO CHIARO	PZ	



Maglia HH Lifa Merino Crew

Maglia aderente a manica lunga Helly Hansen Lifa Merino Crew con ottimo isolamento e il massimo comfort per un utilizzo quotidiano nei giorni invernali. Costruita con due strati: esterno in lana Merino 100% ed interno in tessuto 215 g/m² HH LIFA®. Materiale non irritante e cuciture piatte.



Cod.	Taglia	Colore	UM	€
3040490	S	NERO	PZ	
3040491	M	NERO	PZ	
3040492	L	NERO	PZ	
3040493	XL	NERO	PZ	
3040494	2XL	NERO	PZ	



Calz maglia HH Lifa Merino Pant

Calz maglia aderente Helly Hansen Lifa Merino Pant pensata per offrire un ottimo isolamento e il massimo comfort nei giorni invernali. Costruita con due strati: esterno in lana Merino 100% ed interno in tessuto HH LIFA® 215 g/m². Materiale non irritante e cuciture piatte.



Cod.	Taglia	Colore	UM	€
3040520	S	NERO	PZ	
3040521	M	NERO	PZ	
3040522	L	NERO	PZ	
3040523	XL	NERO	PZ	
3040524	2XL	NERO	PZ	



7 SICUREZZA SPORT/ABBIGLIAMENTO/BATTELLI ALAGGIO

T-Shirt HH Lifa

Maglia aderente a manica corta Helly Hansen Lifa pensata per offrire un isolamento leggero e il massimo comfort per un utilizzo quotidiano. Tessuto 125 g/m² HH LIFA® Light ad asciugatura rapida, elevata traspirabilità e massima leggerezza. Cuciture piatte.

Cod.	Taglia	Colore	UM	€
3040241TW	S	BIANCO	PZ	
3040242TW	M	BIANCO	PZ	
3040243TW	L	BIANCO	PZ	
3040244TW	XL	BIANCO	PZ	
3040245TW	2XL	BIANCO	PZ	
3040241TB	S	NERO	PZ	
3040242TB	M	NERO	PZ	
3040243TB	L	NERO	PZ	
3040244TB	XL	NERO	PZ	
3040245TB	2XL	NERO	PZ	



Maglia HH Lifa Crew

Maglia aderente a manica lunga Helly Hansen Lifa Crew pensata per offrire un isolamento leggero e il massimo comfort per un utilizzo quotidiano. Tessuto 125 g/m² realizzato con il 100% di fibre LIFA® ad asciugatura rapida, elevata traspirabilità e massima leggerezza. Cuciture piatte.

Cod.	Taglia	Colore	UM	€
3040241	S	NERO	PZ	
3040242	M	NERO	PZ	
3040243	L	NERO	PZ	
3040244	XL	NERO	PZ	
3040245	2XL	NERO	PZ	



Calzamaglia HH Lifa Pant

Calzamaglia aderente Helly Hansen Lifa Pant pensata per offrire un isolamento leggero e il massimo comfort per un utilizzo quotidiano. Tessuto 125 g/m² realizzato con il 100% di fibre LIFA® ad asciugatura rapida, elevata traspirabilità e massima leggerezza. Cuciture piatte e banda elastica per una elevata vestibilità e libertà di movimento.

Cod.	Taglia	Colore	UM	€
3040341	S	NERO	PZ	
3040342	M	NERO	PZ	
3040343	L	NERO	PZ	
3040344	XL	NERO	PZ	
3040345	2XL	NERO	PZ	



T-Shirt HH Tech T

T-Shirt a manica corta Helly Hansen Tech T ideale per molteplici attività sportive. Tessuto tecnico leggero in Poliestere 140 g/m² ad asciugatura rapida, traspirante, soffic e comodo sulla pelle. Cuciture piatte.



Cod.	Taglia	Colore	UM	€
3040221	S	BIANCO	PZ	
3040222	M	BIANCO	PZ	
3040223	L	BIANCO	PZ	
3040224	XL	BIANCO	PZ	
3040225	2XL	BIANCO	PZ	
3040231	S	GRIGIO CHIARO	PZ	
3040232	M	GRIGIO CHIARO	PZ	
3040233	L	GRIGIO CHIARO	PZ	
3040234	XL	GRIGIO CHIARO	PZ	
3040235	2XL	GRIGIO CHIARO	PZ	
3040236	S	GRIGIO EBANO	PZ	
3040237	M	GRIGIO EBANO	PZ	
3040238	L	GRIGIO EBANO	PZ	
3040239	XL	GRIGIO EBANO	PZ	
3040240	2XL	GRIGIO EBANO	PZ	
3040226	S	BLUE NAVY	PZ	
3040227	M	BLUE NAVY	PZ	
3040228	L	BLUE NAVY	PZ	
3040229	XL	BLUE NAVY	PZ	
3040230	2XL	BLUE NAVY	PZ	



T-Shirt HH Tech T Donna

T-Shirt a manica corta Helly Hansen Tech T ideale per molteplici attività sportive. Tessuto tecnico leggero in Poliestere 140 g/m² ad asciugatura rapida, traspirante, soffic e comodo sulla pelle. Cuciture piatte.



Cod.	Taglia	Colore	UM	€
3040285	XS	BIANCO	PZ	
3040286	S	BIANCO	PZ	
3040287	M	BIANCO	PZ	
3040288	L	BIANCO	PZ	
3040289	XL	BIANCO	PZ	
3040280	XS	GRIGIO CHIARO	PZ	
3040281	S	GRIGIO CHIARO	PZ	
3040282	M	GRIGIO CHIARO	PZ	
3040283	L	GRIGIO CHIARO	PZ	
3040284	XL	GRIGIO CHIARO	PZ	
3041230	XS	BLUE NAVY	PZ	
3041231	S	BLUE NAVY	PZ	
3041232	M	BLUE NAVY	PZ	
3041233	L	BLUE NAVY	PZ	
3041234	XL	BLUE NAVY	PZ	



Polo HH Crewline

Polo Helly Hansen Crewline in tessuto Piqué a nido d'ape 195 g/m² Tactel® ad asciugatura rapida, colletto e bordi manica a coste, spacchi laterali e protezione UPF50+ da raggi UV.



Cod.	Taglia	Colore	UM	€
3040201	S	BIANCO	PZ	
3040202	M	BIANCO	PZ	
3040203	L	BIANCO	PZ	
3040204	XL	BIANCO	PZ	
3040205	2XL	BIANCO	PZ	
3040206	3XL	BIANCO	PZ	
3040211	S	BLUE NAVY	PZ	
3040212	M	BLUE NAVY	PZ	
3040213	L	BLUE NAVY	PZ	
3040214	XL	BLUE NAVY	PZ	
3040215	2XL	BLUE NAVY	PZ	
3040216	3XL	BLUE NAVY	PZ	
3041201	S	GRIGIO CHIARO	PZ	
3041202	M	GRIGIO CHIARO	PZ	
3041203	L	GRIGIO CHIARO	PZ	
3041204	XL	GRIGIO CHIARO	PZ	
3041205	2XL	GRIGIO CHIARO	PZ	
3041206	3XL	GRIGIO CHIARO	PZ	
3041211	S	GRIGIO EBANO	PZ	
3041212	M	GRIGIO EBANO	PZ	
3041213	L	GRIGIO EBANO	PZ	
3041214	XL	GRIGIO EBANO	PZ	
3041215	2XL	GRIGIO EBANO	PZ	
3041216	3XL	GRIGIO EBANO	PZ	



Polo HH Crewline Donna

Polo Helly Hansen Crewline in tessuto Piqué a nido d'ape 195 g/m² Tactel® ad asciugatura rapida, colletto e bordi manica a coste, spacchi laterali e protezione UPF40+ da raggi UV.



Cod.	Taglia	Colore	UM	€
3040260	XS	BIANCO	PZ	
3040261	S	BIANCO	PZ	
3040262	M	BIANCO	PZ	
3040263	L	BIANCO	PZ	
3040264	XL	BIANCO	PZ	
3040270	XS	BLUE NAVY	PZ	
3040271	S	BLUE NAVY	PZ	
3040272	M	BLUE NAVY	PZ	
3040273	L	BLUE NAVY	PZ	
3040274	XL	BLUE NAVY	PZ	
3040275	XS	GRIGIO EBANO	PZ	
3040276	S	GRIGIO EBANO	PZ	
3040277	M	GRIGIO EBANO	PZ	
3040278	L	GRIGIO EBANO	PZ	
3040279	XL	GRIGIO EBANO	PZ	





Giacca Cerata HH Storm Rain Jacket

Giacca cerata Helly Hansen Storm Rain Jacket in tessuto di Poliestere 310 g/m² spalmato di PVC ideale per proteggersi dall'acqua durante la pesca o in qualsiasi attività a bordo e in banchina. Con chiusura a zip a doppia copertura di protezione, tasca interna con zip e fori per cuffie, spalle senza cuciture, cappuccio con cordino di regolazione, polsini in Neoprene e targhetta portadocumento di identificazione.

Cod.	Taglia	Colore	UM	€
3040610	XS	NERO	PZ	
3040611	S	NERO	PZ	
3040612	M	NERO	PZ	
3040613	L	NERO	PZ	
3040614	XL	NERO	PZ	
3040615	2XL	NERO	PZ	
3040616	3XL	NERO	PZ	
3040620	XS	ARANCIO	PZ	
3040621	S	ARANCIO	PZ	
3040622	M	ARANCIO	PZ	
3040623	L	ARANCIO	PZ	
3040624	XL	ARANCIO	PZ	
3040625	2XL	ARANCIO	PZ	
3040626	3XL	ARANCIO	PZ	



Salopette HH Storm Rain Bib

Salopette Helly Hansen Storm Rain Bib in tessuto di Poliestere 310 g/m² spalmato di PVC ideale per proteggersi dall'acqua durante la pesca o in qualsiasi attività a bordo e in banchina. Con tasca frontale interna con zip e bretelle elastiche.

Cod.	Taglia	Colore	UM	€
3040630	XS	NERO	PZ	
3040631	S	NERO	PZ	
3040632	M	NERO	PZ	
3040633	L	NERO	PZ	
3040634	XL	NERO	PZ	
3040635	2XL	NERO	PZ	
3040636	3XL	NERO	PZ	
3040640	XS	ARANCIO	PZ	
3040641	S	ARANCIO	PZ	
3040642	M	ARANCIO	PZ	
3040643	L	ARANCIO	PZ	
3040644	XL	ARANCIO	PZ	
3040645	2XL	ARANCIO	PZ	
3040646	3XL	ARANCIO	PZ	



7 SICUREZZA SPORT/ABBIGLIAMENTO/BATTELLI ALAGGIO



Giacca Cerata HH Gale Rain Jacket

Giacca cerata Helly Hansen Gale Rain Jacket in tessuto di Poliestere 240 g/m² spalmato di PU ideale per proteggersi dall'acqua durante la pesca o in qualsiasi attività a bordo e in banchina. Con chiusura a zip a doppia copertura di protezione, tasca interna con zip e fori per cuffie, due tasche frontali, cappuccio con cordino di regolazione, polsini in Neoprene, fondo giacca regolabile e targhetta portadocumento di identificazione.



Cod.	Taglia	Colore	UM	€
3040650	XS	BLUE NAVY	PZ	
3040651	S	BLUE NAVY	PZ	
3040652	M	BLUE NAVY	PZ	
3040653	L	BLUE NAVY	PZ	
3040654	XL	BLUE NAVY	PZ	
3040655	2XL	BLUE NAVY	PZ	
3040656	3XL	BLUE NAVY	PZ	
3040660	XS	ARANCIO	PZ	
3040661	S	ARANCIO	PZ	
3040662	M	ARANCIO	PZ	
3040663	L	ARANCIO	PZ	
3040664	XL	ARANCIO	PZ	
3040665	2XL	ARANCIO	PZ	
3040666	3XL	ARANCIO	PZ	



Pantalone HH Gale Rain Pant

Pantalone Helly Hansen Gale Rain Pant in tessuto di Poliestere 240 g/m² spalmato di PU ideale per proteggersi dall'acqua durante la pesca o in qualsiasi attività a bordo e in banchina. Con elastico e cordino di regolazione in vita e bordo inferiore regolabile con bottoni.



Cod.	Taglia	Colore	UM	€
3040670	XS	BLUE NAVY	PZ	
3040671	S	BLUE NAVY	PZ	
3040672	M	BLUE NAVY	PZ	
3040673	L	BLUE NAVY	PZ	
3040674	XL	BLUE NAVY	PZ	
3040675	2XL	BLUE NAVY	PZ	
3040676	3XL	BLUE NAVY	PZ	
3040680	XS	ARANCIO	PZ	
3040681	S	ARANCIO	PZ	
3040682	M	ARANCIO	PZ	
3040683	L	ARANCIO	PZ	
3040684	XL	ARANCIO	PZ	
3040685	2XL	ARANCIO	PZ	
3040686	3XL	ARANCIO	PZ	



Giacca Cerata HH Mandal Jacket

Giacca cerata Helly Hansen Mandal Jacket in tessuto di Poliestere 410 g/m² spalmato di PU ideale per proteggersi dall'acqua durante la pesca o in qualsiasi attività a bordo e in banchina. Con due tasche frontali e cappuccio con cordino di regolazione.

Cod.	Taglia	Colore	UM	€
3040870	XS	ARANCIO	PZ	
3040871	S	ARANCIO	PZ	
3040872	M	ARANCIO	PZ	
3040873	L	ARANCIO	PZ	
3040874	XL	ARANCIO	PZ	
3040875	2XL	ARANCIO	PZ	
3040876	3XL	ARANCIO	PZ	
3040880	XS	GIALLO	PZ	
3040881	S	GIALLO	PZ	
3040882	M	GIALLO	PZ	
3040883	L	GIALLO	PZ	
3040884	XL	GIALLO	PZ	
3040885	2XL	GIALLO	PZ	
3040886	3XL	GIALLO	PZ	



Salopette HH Mandal Bib

Salopette Helly Hansen Mandal Bib in tessuto di Poliestere 410 g/m² spalmato di PU ideale per proteggersi dall'acqua durante la pesca o in qualsiasi attività a bordo e in banchina. Con tasca frontale interna con zip, bretelle elastiche regolabili e bordo inferiore regolabile con bottoni.

Cod.	Taglia	Colore	UM	€
3040902	S	ARANCIO	PZ	
3040903	M	ARANCIO	PZ	
3040904	L	ARANCIO	PZ	
3040905	XL	ARANCIO	PZ	
3040906	2XL	ARANCIO	PZ	
3040907	3XL	ARANCIO	PZ	

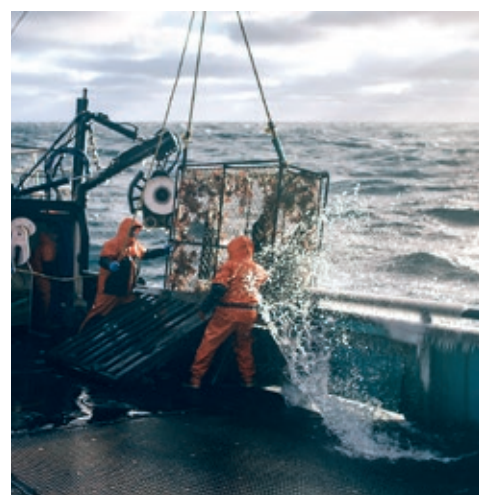

Cappello HH Svolvaer

Cappello Helly Hansen Svolvaer in tessuto di Poliestere 410 g/m² spalmato di PU ideale per proteggersi dall'acqua durante la pesca o in qualsiasi attività a bordo e in banchina. Con fodera, cordino di regolazione e para orecchie.

Cod.	Taglia	Colore	UM	€
3040897	M	GIALLO	PZ	
3040898	L	GIALLO	PZ	
3040899	XL	GIALLO	PZ	



Giacca HH Kensington Hooded Lifaloft Jacket

Giacca Helly Hansen Kensington Hooded Lifaloft Jacket ideale per tutto l'anno in qualsiasi condizione. Mantiene il calore anche quando è umida grazie all'imbottitura rivoluzionaria Lifaloft™ che consente di restare al caldo con meno peso e ingombro. In tessuto softshell con membrana e trattamento idrorepellente DWR (Durable Water Repellency). Con spalle senza cuciture, cappuccio regolabile con cordino elastico, tasche interne portaoggetti, maniche perforate, polsini regolabili e parte posteriore più lunga per un maggior comfort.



Cod.	Taglia	Colore	UM	€
3041550	S	NERO	PZ	
3041551	M	NERO	PZ	
3041552	L	NERO	PZ	
3041553	XL	NERO	PZ	
3041554	2XL	NERO	PZ	
3041555	3XL	NERO	PZ	

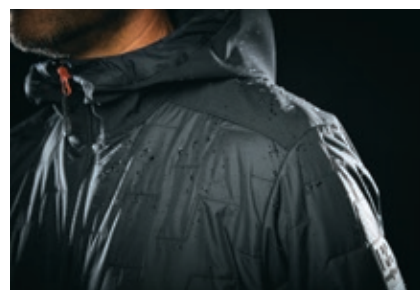

Gilet HH Kensington Lifaloft Vest

Gilet smanicato Helly Hansen Kensington Lifaloft Vest ideale per tutto l'anno in qualsiasi condizione. Mantiene il calore anche quando è umida grazie all'imbottitura rivoluzionaria Lifaloft™ che consente di restare al caldo con meno peso e ingombro. In tessuto softshell con membrana e trattamento idrorepellente DWR (Durable Water Repellency). Perfetto da usare sotto la giacca Kensington Hooded Lifaloft Jacket nelle giornate più fredde.



Cod.	Taglia	Colore	UM	€
3041560	S	NERO	PZ	
3041561	M	NERO	PZ	
3041562	L	NERO	PZ	
3041563	XL	NERO	PZ	
3041564	2XL	NERO	PZ	
3041565	3XL	NERO	PZ	



Giacca HH Oxford Shell Jacket

Giacca Helly Hansen Oxford Shell Jacket con cuciture completamente nastrate e membrana Helly Tech® Performance di ottima traspirabilità pur rimanendo impermeabile. Comoda e resistente all'usura grazie al tessuto ripstop. Con cappuccio rimovibile e regolabile, tasca interna sul petto, polsini e bordo regolabili, parte posteriore più lunga per un maggior comfort. Indossata da sola o abbinata a uno strato base e a un pile, questa giacca è utilizzabile tutto l'anno.



Cod.	Taglia	Colore	UM	€
3041300	S	NERO	PZ	
3041301	M	NERO	PZ	
3041302	L	NERO	PZ	
3041303	XL	NERO	PZ	
3041304	2XL	NERO	PZ	
3041305	3XL	NERO	PZ	



Giacca HH Oxford Winter Jacket

Giacca Helly Hansen Oxford Winter Jacket dotata di membrana Helly Tech® Performance e imbottitura Primaloft® vi tiene caldi, asciutti e confortevoli sia con la pioggia che con la neve. Le spalle senza cuciture assicurano resistenza in una zona ad alto impatto, ma anche il massimo comfort quando si trasporta uno zaino o un'attrezzatura. Con cappuccio rimovibile e regolabile, tasca interna sul petto, polsini e bordo regolabili, parte posteriore più lunga per un maggior comfort.



Cod.	Taglia	Colore	UM	€
3041310	S	BLUE NAVY	PZ	
3041311	M	BLUE NAVY	PZ	
3041312	L	BLUE NAVY	PZ	
3041313	XL	BLUE NAVY	PZ	
3041314	2XL	BLUE NAVY	PZ	
3041315	3XL	BLUE NAVY	PZ	
3041320	S	NERO	PZ	
3041321	M	NERO	PZ	
3041322	L	NERO	PZ	
3041323	XL	NERO	PZ	
3041324	2XL	NERO	PZ	
3041325	3XL	NERO	PZ	

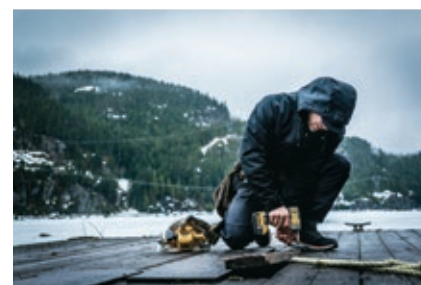

7 SICUREZZA SPORT/ABBIGLIAMENTO/BATTELLI ALAGGIO

Giacca HH Oxford Insulator

Giacca termica Helly Hansen Oxford Insulated Jacket in resistente tessuto in poliestere/cotone dal look moderno ed elegante. L'imbottitura Primaloft® assicura il massimo calore senza aggiungere peso. Con zip sul davanti con mentoniera, colletto interno e tasche per le mani in poliestere spazzolato, tasche sul petto con zip, bordo regolabile e passante per tesserino di riconoscimento.



Cod.	Taglia	Colore	UM	€
3041350	S	NERO	PZ	
3041351	M	NERO	PZ	
3041352	L	NERO	PZ	
3041353	XL	NERO	PZ	
3041354	2XL	NERO	PZ	
3041355	3XL	NERO	PZ	



Salopette HH Oxford Bib

Le salopette Helly Hansen Oxford Bib con bretelle elastiche e tessuto elasticizzato 4-way sui lati rappresentano la scelta perfetta di comfort e durata. Con tasca sul petto con chiusura in velcro, elastico in vita per libertà di movimento, ampio passante per cintura, tasche posteriori, tasca sulla coscia con chiusura a scatto, rinforzi sulle ginocchia e fondo gamba, tasche sulle ginocchiere accessibili dall'interno e lunghezza della gamba estendibile di 5 cm.



Cod.	Taglia	Colore	UM	€
3041330	46	BLUE NAVY	PZ	
3041331	48	BLUE NAVY	PZ	
3041332	50	BLUE NAVY	PZ	
3041333	52	BLUE NAVY	PZ	
3041334	54	BLUE NAVY	PZ	
3041335	56	BLUE NAVY	PZ	
3041336	58	BLUE NAVY	PZ	
3041340	46	NERO	PZ	
3041341	48	NERO	PZ	
3041342	50	NERO	PZ	
3041343	52	NERO	PZ	
3041344	54	NERO	PZ	
3041345	56	NERO	PZ	
3041346	58	NERO	PZ	



Giacca HH Oxford Fleece Jacket

Giacca Helly Hansen Oxford Fleece Jacket comoda e affidabile sia da sola che come strato intermedio nei giorni più freddi. L'utilizzo di pile riciclato Polartec® la rende una scelta perfetta per chi la indossa e per l'ambiente. Con colletto con doppio strato di tessuto, tasca sul petto, tasche laterali con zip e cuciture piatte per il massimo comfort.

Cod.	Taglia	Colore	UM	€
3041370	S	BLUE NAVY	PZ	
3041371	M	BLUE NAVY	PZ	
3041372	L	BLUE NAVY	PZ	
3041373	XL	BLUE NAVY	PZ	
3041374	2XL	BLUE NAVY	PZ	
3041375	3XL	BLUE NAVY	PZ	
3041380	S	NERO	PZ	
3041381	M	NERO	PZ	
3041382	L	NERO	PZ	
3041383	XL	NERO	PZ	
3041384	2XL	NERO	PZ	
3041385	3XL	NERO	PZ	



Giacca HH Oxford Light Fleece Jacket

Giacca Helly Hansen Oxford Light Fleece Jacket perfetta come strato intermedio nelle giornate un po' più fredde. L'utilizzo del pile riciclato Polartec® la rende una scelta perfetta per chi la indossa e per l'ambiente. Con colletto con doppio strato di tessuto, tasche laterali con zip e cuciture piatte per il massimo comfort.

Cod.	Taglia	Colore	UM	€
3041390	S	BLUE NAVY	PZ	
3041391	M	BLUE NAVY	PZ	
3041392	L	BLUE NAVY	PZ	
3041393	XL	BLUE NAVY	PZ	
3041394	2XL	BLUE NAVY	PZ	
3041395	3XL	BLUE NAVY	PZ	
3041400	S	NERO	PZ	
3041401	M	NERO	PZ	
3041402	L	NERO	PZ	
3041403	XL	NERO	PZ	
3041404	2XL	NERO	PZ	
3041405	3XL	NERO	PZ	



7 SICUREZZA SPORT/ABBIGLIAMENTO/BATTELLI ALAGGIO

Pantalone HH Chelsea Evolution Service Pant

Pantalone Helly Hansen Chelsea Evolution Service Pant di resistenza e comfort ottimali grazie al tessuto elasticizzato 4-way nei punti strategici che assicura la massima libertà di movimento. Il tessuto rinforzato su ginocchia e fondo gamba protegge i pantaloni e chi li indossa dall'usura quotidiana. Con tasche per mani, passanti porta martello su entrambi i lati, ampio passante per cintura, tasche posteriori, tasca sulla coscia con chiusura a scatto, tasche sulle ginocchiere accessibili dall'interno e lunghezza della gamba estendibile di 5 cm.



Cod.	Taglia	Colore	UM	€
3041480	46	BLUE NAVY	PZ	
3041481	48	BLUE NAVY	PZ	
3041482	50	BLUE NAVY	PZ	
3041483	52	BLUE NAVY	PZ	
3041484	54	BLUE NAVY	PZ	
3041485	56	BLUE NAVY	PZ	
3041486	58	BLUE NAVY	PZ	
3041490	46	NERO	PZ	
3041491	48	NERO	PZ	
3041492	50	NERO	PZ	
3041493	52	NERO	PZ	
3041494	54	NERO	PZ	
3041495	56	NERO	PZ	
3041496	58	NERO	PZ	



Pantalone HH Oxford Work Pant

Pantalone Helly Hansen Oxford Pant di resistenza e comfort ottimali grazie al tessuto elasticizzato 2-way nei punti strategici che assicura la massima libertà di movimento. Il tessuto rinforzato su ginocchia e fondo gamba protegge i pantaloni e chi li indossa dall'usura quotidiana. Con tasche per mani, passanti porta martello su entrambi i lati, ampio passante per cintura, tasche posteriori, tasca sulla coscia con chiusura a scatto, tasche sulle ginocchiere accessibili dall'interno e lunghezza della gamba estendibile di 5 cm.



Cod.	Taglia	Colore	UM	€
3041410	46	BLUE NAVY	PZ	
3041411	48	BLUE NAVY	PZ	
3041412	50	BLUE NAVY	PZ	
3041413	52	BLUE NAVY	PZ	
3041414	54	BLUE NAVY	PZ	
3041415	56	BLUE NAVY	PZ	
3041416	58	BLUE NAVY	PZ	
3041420	46	NERO	PZ	
3041421	48	NERO	PZ	
3041422	50	NERO	PZ	
3041423	52	NERO	PZ	
3041424	54	NERO	PZ	
3041425	56	NERO	PZ	
3041426	58	NERO	PZ	



Pantaloncini HH Oxford Service Shorts

Pantaloncini Helly Hansen Oxford Shorts assicurano un livello di comfort e durata unico grazie al tessuto elasticizzato 2-way che ne rende i movimenti più facili ed efficienti in qualsiasi situazione quotidiana. Con tasche per mani, ampio passante per cintura, tasche posteriori e tasca sulla coscia con chiusura a scatto.



Cod.	Taglia	Colore	UM	€
3041430	46	BLUE NAVY	PZ	
3041431	48	BLUE NAVY	PZ	
3041432	50	BLUE NAVY	PZ	
3041433	52	BLUE NAVY	PZ	
3041434	54	BLUE NAVY	PZ	
3041435	56	BLUE NAVY	PZ	
3041436	58	BLUE NAVY	PZ	
3041440	46	NERO	PZ	
3041441	48	NERO	PZ	
3041442	50	NERO	PZ	
3041443	52	NERO	PZ	
3041444	54	NERO	PZ	
3041445	56	NERO	PZ	
3041446	58	NERO	PZ	



Maglia HH Lifa Max Half Zip

Maglia aderente a manica lunga Helly Hansen Lifa Max Half Zip in tessuto 230 g/m² a doppio strato 100% Lifa®. La tecnologia Lifa® Stay Warm assicura che il sudore venga trasportato lontano dalla pelle mentre il doppio strato offre il calore. Intimo di massima termicità con zip sul davanti e mentoniera, spalle senza cuciture e cuciture piatte per il massimo comfort.



Cod.	Taglia	Colore	UM	€
3041450	S	NERO	PZ	
3041451	M	NERO	PZ	
3041452	L	NERO	PZ	
3041453	XL	NERO	PZ	
3041454	2XL	NERO	PZ	
3041455	3XL	NERO	PZ	



Maglia HH Lifa Max Crewneck

Maglia aderente a manica lunga Helly Hansen Lifa Max Crewneck in tessuto 230 g/m² a doppio strato 100% Lifa®. La tecnologia Lifa® Stay Warm assicura che il sudore venga trasportato lontano dalla pelle mentre il doppio strato offre il calore. Intimo di massima termicità con spalle senza cuciture e cuciture piatte per il massimo comfort.



Cod.	Taglia	Colore	UM	€
3041460	S	NERO	PZ	
3041461	M	NERO	PZ	
3041462	L	NERO	PZ	
3041463	XL	NERO	PZ	
3041464	2XL	NERO	PZ	
3041465	3XL	NERO	PZ	



Calz maglia HH Lifa Max Pant

Calz maglia aderente Helly Hansen Lifa Max Pant in tessuto 230 g/m² a doppio strato 100% Lifa®. La tecnologia Lifa® Stay Warm assicura che il sudore venga trasportato lontano dalla pelle mentre il doppio strato offre il calore. Intimo di massima termicità con elastico in vita per una vestibilità e una libertà di movimento insuperabili, gherone all'inguine e cuciture piatte per il massimo comfort.



Cod.	Taglia	Colore	UM	€
3041470	S	NERO	PZ	
3041471	M	NERO	PZ	
3041472	L	NERO	PZ	
3041473	XL	NERO	PZ	
3041474	2XL	NERO	PZ	
3041475	3XL	NERO	PZ	



7 SICUREZZA SPORT/ABBIGLIAMENTO/BATTELLI ALAGGIO

Polo HH Oxford

Polo Helly Hansen Oxford in 100% morbido cotone 210 g/m² con cuciture piatte a contrasto di colore.

Cod.	Taglia	Colore	UM	€
3040780	S	GRIGIO CHIARO	PZ	
3040781	M	GRIGIO CHIARO	PZ	
3040782	L	GRIGIO CHIARO	PZ	
3040783	XL	GRIGIO CHIARO	PZ	
3040784	2XL	GRIGIO CHIARO	PZ	
3040785	3XL	GRIGIO CHIARO	PZ	
3040790	S	BLUE NAVY	PZ	
3040791	M	BLUE NAVY	PZ	
3040792	L	BLUE NAVY	PZ	
3040793	XL	BLUE NAVY	PZ	
3040794	2XL	BLUE NAVY	PZ	
3040795	3XL	BLUE NAVY	PZ	
3040801	S	NERO	PZ	
3040802	M	NERO	PZ	
3040803	L	NERO	PZ	
3040804	XL	NERO	PZ	
3040805	2XL	NERO	PZ	
3040806	3XL	NERO	PZ	
3040810	S	BLU	PZ	
3040811	M	BLU	PZ	



Cod.	Taglia	Colore	UM	€
3040812	L	BLU	PZ	
3040813	XL	BLU	PZ	
3040814	2XL	BLU	PZ	
3040815	3XL	BLU	PZ	



T-Shirt HH Oxford

T-Shirt Helly Hansen Oxford in 100% morbido e leggero cotone 200 g/m² con cuciture piatte a contrasto di colore.

Cod.	Taglia	Colore	UM	€
3040820	S	GRIGIO CHIARO	PZ	
3040821	M	GRIGIO CHIARO	PZ	
3040822	L	GRIGIO CHIARO	PZ	
3040823	XL	GRIGIO CHIARO	PZ	
3040824	2XL	GRIGIO CHIARO	PZ	
3040825	3XL	GRIGIO CHIARO	PZ	
3040830	S	BLUE NAVY	PZ	
3040831	M	BLUE NAVY	PZ	
3040832	L	BLUE NAVY	PZ	
3040833	XL	BLUE NAVY	PZ	
3040834	2XL	BLUE NAVY	PZ	
3040835	3XL	BLUE NAVY	PZ	
3040840	S	NERO	PZ	
3040841	M	NERO	PZ	
3040842	L	NERO	PZ	
3040843	XL	NERO	PZ	
3040844	2XL	NERO	PZ	
3040845	3XL	NERO	PZ	
3040850	S	BLU	PZ	
3040851	M	BLU	PZ	



Cod.	Taglia	Colore	UM	€
3040852	L	BLU	PZ	
3040853	XL	BLU	PZ	
3040854	2XL	BLU	PZ	
3040855	3XL	BLU	PZ	



T-Shirt HH Manchester

T-Shirt Helly Hansen Manchester in 100% morbido e leggero cotone 150 g/m² con cuciture laterali e colletto a coste.

Cod.	Taglia	Colore	UM	€
3041110	S	BIANCO	PZ	
3041111	M	BIANCO	PZ	
3041112	L	BIANCO	PZ	
3041113	XL	BIANCO	PZ	
3041114	2XL	BIANCO	PZ	
3041115	3XL	BIANCO	PZ	
3041120	S	BLUE NAVY	PZ	
3041121	M	BLUE NAVY	PZ	
3041122	L	BLUE NAVY	PZ	
3041123	XL	BLUE NAVY	PZ	
3041124	2XL	BLUE NAVY	PZ	
3041125	3XL	BLUE NAVY	PZ	
3041130	S	NERO	PZ	
3041131	M	NERO	PZ	
3041132	L	NERO	PZ	
3041133	XL	NERO	PZ	
3041134	2XL	NERO	PZ	
3041135	3XL	NERO	PZ	
3041140	S	GRIGIO SCURO	PZ	
3041141	M	GRIGIO SCURO	PZ	
3041142	L	GRIGIO SCURO	PZ	



Cod.	Taglia	Colore	UM	€
3041143	XL	GRIGIO SCURO	PZ	
3041144	2XL	GRIGIO SCURO	PZ	
3041145	3XL	GRIGIO SCURO	PZ	

Guanti HH Sailing Gloves

Guanti Helly Hansen Sailing Gloves in tessuto resistente, struttura ergonomica e polso regolabile. Disponibili in versione con dita a 3/4 oppure con dita intere.

Cod.	L dita	Taglia	UM	€
3049510	3/4	XS	CP	
3049511	3/4	S	CP	
3049512	3/4	M	CP	
3049513	3/4	L	CP	
3049514	3/4	XL	CP	
3049500	Intere	XS	CP	
3049501	Intere	S	CP	
3049502	Intere	M	CP	
3049503	Intere	L	CP	
3049504	Intere	XL	CP	



Visiera HH Crew Visor

Visiera Helly Hansen Crew Visor in 100% cotone effetto lavato. Regolabile sul dietro, con visiera e logo HH®.

Cod.	Colore	UM	€
3049804	BIANCO	PZ	
3049805	BLUE NAVY	PZ	



Cappellino HH Crew Cap

Cappellino Helly Hansen Crew Cap in 100% cotone effetto lavato. Regolabile sul dietro, con visiera e logo HH®.

Cod.	Colore	UM	€
3049800	BIANCO	PZ	
3049801	BLUE NAVY	PZ	
3049802	NERO	PZ	



Berretto HH Fleece Beanie

Berretto classico in pile Helly Hansen Fleece Beanie in tessuto Polartec® riciclato, morbido e confortevole.

Cod.	Colore	UM	€
3049822	NERO	PZ	



Berretto HH Sea Gear

Berretto invernale d'ispirazione rétro Helly Hansen con logo Sea Gear in Acrilico 100%.

Cod.	Colore	UM	€
3049807	NERO	PZ	
3049808	BLUE NAVY	PZ	



Berretto HH Kensington

Berretto Helly Hansen Kensington in acrilico lavorato a maglia.



Cod.	Colore	UM	€
3049810	BLUE NAVY	PZ	
3049811	NERO	PZ	
3049812	GRIGIO CHIARO	PZ	
3049813	ARANCIO	PZ	



Berretto HH Lifa Merino

Berretto Helly Hansen Lifa Merino in tessuto a doppio strato di lana e Polipropilene 215 g/m² con cuciture piatte per il massimo comfort ed isolamento.



Cod.	Colore	UM	€
3049817	NERO	PZ	
3049818	GRIGIO	PZ	



Berretto HH Lifa Max

Berretto Helly Hansen Lifa Max in tessuto a doppio strato 100% Lifa® che allontana l'umidità dalla pelle e Polipropilene 230 g/m² con cuciture piatte per il massimo comfort ed isolamento.



Cod.	Colore	UM	€
3049823	BLUE NAVY	PZ	
3049824	NERO	PZ	



Scaldacollo HH Lifa Max Neck Gaiter

Scaldacollo Helly Hansen Lifa Max Neck Gaiter in tessuto a doppio strato 100% Lifa® che allontana l'umidità dalla pelle e Polipropilene 230 g/m² con cuciture piatte per il massimo comfort ed isolamento.



Cod.	Colore	UM	€
3049825	BLUE NAVY	PZ	
3049826	NERO	PZ	







Borsa HH Scout Duffel

Borsa Helly Hansen Scout Duffel in tessuto 600D impermeabile e resistente all'usura con ampio scomparto principale a chiusura zip, pratica apertura laterale a U con zip, scomparto esterno con zip, maniglie standard e cinghie imbottite da spalla con maniglia.



Cod.	Capacità Lt	Dim cm	Colore	UM	€
3049730	30	55 x 30 x H25	NERO	PZ	
3049735	50	70 x 30 x H25	NERO	PZ	
3049740	70	75 x 35 x H30	NERO	PZ	
3049745	90	75 x 40 x H35	NERO	PZ	
3049780 	30	55 x 30 x H25	BLU OCEAN	PZ	
3049785 	50	70 x 30 x H25	BLU OCEAN	PZ	
3049790 	70	75 x 35 x H30	BLU OCEAN	PZ	



Borsa HH Duffel Bag

Borsa da lavoro Helly Hansen Duffel in tessuto impermeabile con ampio scomparto principale a chiusura zip, tasca interna imbottita per PC portatile, scomparto per kit di pronto soccorso, scomparto esterno per scarpe, maniglie con tracolla imbottita e targhetta porta documento d'identificazione.



Cod.	Capacità Lt	Colore	UM	€
3049750	50	NERO	PZ	
3049751	70	NERO	PZ	
3049752	90	NERO	PZ	



Zaino HH Stockholm Backpack

Zaino Helly Hansen Stockholm Backpack in tessuto impermeabile e resistente all'usura con ampio scomparto principale a chiusura roll-up con fibbie, scomparto esterno con zip e cinghie da spalla regolabili imbottite.



Cod.	Capacità Lt	Dim cm	Colore	UM	€
3049724	28	45 x 15 x 30	NERO	PZ	
3049726	28	45 x 15 x 30	GRIGIO	PZ	



Zaino HH Work Backpack

Zaino da lavoro Helly Hansen Work Backpack in tessuto resistente all'acqua con scomparto principale a chiusura zip, tasca interna imbottita per PC portatile, tasca porta bottiglie, scomparto per kit di pronto soccorso, due tasche frontali e laterali, vari vani porta attrezzi e D-ring. Misure compatibili alle dimensioni per bagaglio a mano in aereo.



Cod.	Capacità Lt	Colore	UM	€
3049702	27	NERO	PZ	



7 SICUREZZA SPORT/ABBIGLIAMENTO/BATTELLI ALAGGIO

Beauty Case HH Scout Duffel Wash Bag

Necessaire da viaggio Helly Hansen Scout Duffel Wash Bag in tessuto impermeabile e resistente all'usura.



Cod.	Colore	UM	€
3049760	NERO	PZ	
3049770	BLU OCEAN	PZ	



- HELLY HANSEN SCARPE E STIVALI -

Scarpa HH Crest Watermoc

Scarpa Helly Hansen ideale per tutti gli sport acquatici, per le attività nautiche e per la spiaggia. Leggera, costruita in materiale resistente, traspirante e ad asciugatura rapida. Con suola in gomma flessibile HellyGrip che garantisce stabilità e una tenuta perfetta.



Cod.	Numero	Colore	UM	€
3041050	40,5 (7,5)	NERO	CP	
3041051	41 (8)	NERO	CP	
3041052	42 (8,5)	NERO	CP	
3041053	42,5 (9)	NERO	CP	
3041054	43 (9,5)	NERO	CP	
3041055	44 (10)	NERO	CP	
3041056	44,5 (10,5)	NERO	CP	
3041057	45 (11)	NERO	CP	
3041058	46 (11,5)	NERO	CP	



Scarpa HH Crest Watermoc Donna

Scarpa Helly Hansen ideale per tutti gli sport acquatici, per le attività nautiche e per la spiaggia. Leggera, costruita in materiale resistente, traspirante e ad asciugatura rapida. Con suola in gomma flessibile HellyGrip che garantisce stabilità e una tenuta perfetta.



Cod.	Numero	Colore	UM	€
3041070	37 (6)	NERO	CP	
3041071	37,5 (6,5)	NERO	CP	
3041072	38 (7)	NERO	CP	
3041073	38,5 (7,5)	NERO	CP	
3041074	39,5 (8)	NERO	CP	
3041075	40 (8,5)	NERO	CP	
3041076	40,5 (9)	NERO	CP	
3041077	41 (9,5)	NERO	CP	



Scarpa HH Ahiga V4 Hydropower

Scarpa da vela Helly Hansen molto leggera e versatile costruita in tessuto di rete, flessibile, traspirabile e ad asciugatura rapida. Suolaletta modellata in EVA antibatterico e suola antisdrucchiolo in gomma HellyGrip ad alta flessibilità.



Cod.	Numero	Colore	UM	€
3041040	40,5 (7,5)	BLUE	CP	
3041041	41 (8)	BLUE	CP	
3041042	42 (8,5)	BLUE	CP	
3041043	42,5 (9)	BLUE	CP	
3041044	43 (9,5)	BLUE	CP	
3041045	44 (10)	BLUE	CP	
3041046	44,5 (10,5)	BLUE	CP	
3041047	45 (11)	BLUE	CP	
3041048	46 (11,5)	BLUE	CP	



Scarpa HH Ahiga V4 Hydropower W Bianca

Scarpa da vela Helly Hansen molto leggera e versatile costruita in tessuto di rete, flessibile, traspirabile e ad asciugatura rapida. Suolaletta modellata in EVA antibatterico e suola antisdrucchiolo in gomma HellyGrip ad alta flessibilità.



Cod.	Numero	Colore	UM	€
3041040W	40,5 (7,5)	BIANCO	CP	
3041041W	41 (8)	BIANCO	CP	
3041042W	42 (8,5)	BIANCO	CP	
3041043W	42,5 (9)	BIANCO	CP	
3041044W	43 (9,5)	BIANCO	CP	
3041045W	44 (10)	BIANCO	CP	
3041046W	44,5 (10,5)	BIANCO	CP	
3041047W	45 (11)	BIANCO	CP	
3041048W	46 (11,5)	BIANCO	CP	



Scarpa HH Skagen F-1 Offshore

Scarpa da vela Helly Hansen high-performance sneaker costruita in tessuto di rete senza cuciture, flessibile, traspirabile, idrofobico e ad asciugatura rapida. La suola è progettata per proteggere i piedi dagli ostacoli presenti sul ponte e dalle rocce, con suoletta modellata in EVA antibatterico e con secondo inserto intermedio a densità. Suola flessibile in gomma antigraffio con sistema antisdrucchiolo multi direzionale e canalette di scolo dell'acqua.



Cod.	Numero	Colore	UM	€
3041030	40,5 (7,5)	BLUE NAVY	CP	
3041031	41 (8)	BLUE NAVY	CP	
3041032	42 (8,5)	BLUE NAVY	CP	
3041033	42,5 (9)	BLUE NAVY	CP	
3041034	43 (9,5)	BLUE NAVY	CP	
3041035	44 (10)	BLUE NAVY	CP	
3041036	44,5 (10,5)	BLUE NAVY	CP	
3041037	45 (11)	BLUE NAVY	CP	
3041038	46 (11,5)	BLUE NAVY	CP	
3041030G	40,5 (7,5)	GRIGIO	CP	
3041031G	41 (8)	GRIGIO	CP	
3041032G	42 (8,5)	GRIGIO	CP	
3041033G	42,5 (9)	GRIGIO	CP	
3041034G	43 (9,5)	GRIGIO	CP	
3041035G	44 (10)	GRIGIO	CP	
3041036G	44,5 (10,5)	GRIGIO	CP	
3041037G	45 (11)	GRIGIO	CP	
3041038G	46 (11,5)	GRIGIO	CP	



Scarpa HH Skagen F-1 Offshore Donna

Scarpa da vela Helly Hansen high-performance sneaker costruita in tessuto di rete senza cuciture, flessibile, traspirabile, idrofobico e ad asciugatura rapida. La suola è progettata per proteggere i piedi dagli ostacoli presenti sul ponte e dalle rocce, con suoletta modellata in EVA antibatterico e con secondo inserto intermedio a densità. Suola flessibile in gomma antigraffio con sistema antisdrucchiolo multi direzionale e canalette di scolo dell'acqua.



Cod.	Numero	Colore	UM	€
3041022	37 (6)	BLUE NAVY	CP	
3041023	37,5 (6,5)	BLUE NAVY	CP	
3041024	38 (7)	BLUE NAVY	CP	
3041025	38,5 (7,5)	BLUE NAVY	CP	
3041026	39,5 (8)	BLUE NAVY	CP	
3041027	40 (8,5)	BLUE NAVY	CP	
3041028	40,5 (9)	BLUE NAVY	CP	
3041029	41 (9,5)	BLUE NAVY	CP	



Stivale HH Nordvik

Stivale HH Nordvik leggero, a taglio basso, ideale per le attività nautiche. Unisce in modo semplice stile e comfort. Suola piatta con scanalature che garantiscono una trazione eccezionale.



Cod.	Numero	Colore	UM	€
3019840	40	BLUE NAVY	CP	
3019841	41	BLUE NAVY	CP	
3019842	42,5	BLUE NAVY	CP	
3019843	44	BLUE NAVY	CP	
3019844	45	BLUE NAVY	CP	
3019845	46,5	BLUE NAVY	CP	



7 SICUREZZA SPORT/ABBIGLIAMENTO/BATTELLI ALAGGIO

Scarpa da Lavoro HH Addvis Low

Scarpe antinfortunistiche performanti Helly Hansen Addvis Low certificate S3 con puntale in materiale composito e intersuola con protezione contro la penetrazione di chiodi. Traspiranti e leggere forniscono un'ammortizzazione di lunga durata gestendo l'umidità. Dotate di intersuola in EVA leggera e suola in gomma antiscivolo.



Cod.	Numero	Colore	UM	€
3041500	40	NERO/GIALLO	CP	
3041501	41	NERO/GIALLO	CP	
3041502	42	NERO/GIALLO	CP	
3041503	43	NERO/GIALLO	CP	
3041504	44	NERO/GIALLO	CP	
3041505	45	NERO/GIALLO	CP	
3041506	46	NERO/GIALLO	CP	



Scarpa da Lavoro HH Addvis Mid

Scarpe antinfortunistiche performanti Helly Hansen Addvis Mid certificate S3 con puntale in materiale composito e intersuola con protezione contro la penetrazione di chiodi. Traspiranti e leggere forniscono un'ammortizzazione di lunga durata gestendo l'umidità. Dotate di intersuola in EVA leggera e suola in gomma antiscivolo.



Cod.	Numero	Colore	UM	€
3041510	40	NERO/GIALLO	CP	
3041511	41	NERO/GIALLO	CP	
3041512	42	NERO/GIALLO	CP	
3041513	43	NERO/GIALLO	CP	
3041514	44	NERO/GIALLO	CP	
3041515	45	NERO/GIALLO	CP	
3041516	46	NERO/GIALLO	CP	



Scarpa da Lavoro HH Chelsea Evolution Boa Low

Scarpe antinfortunistiche performanti Helly Hansen Chelsea Evolution Boa Low certificate S3 con puntale in materiale composito e intersuola con protezione contro la penetrazione di chiodi. Traspiranti e leggere forniscono un'ammortizzazione di lunga durata gestendo l'umidità. Dotate di intersuola in EVA leggera e suola in gomma antiscivolo. Il sistema di allacciatura BOA® permette di infilare e sfilare le scarpe con facilità.



Cod.	Numero	Colore	UM	€
3041520	40	NERO/ARANCIO	CP	
3041521	41	NERO/ARANCIO	CP	
3041522	42	NERO/ARANCIO	CP	
3041523	43	NERO/ARANCIO	CP	
3041524	44	NERO/ARANCIO	CP	
3041525	45	NERO/ARANCIO	CP	
3041526	46	NERO/ARANCIO	CP	



Scarpa da Lavoro HH Chelsea Evolution Boa Mid

Scarpe antinfortunistiche performanti Helly Hansen Chelsea Evolution Boa Mid certificate S3 con puntale in materiale composito e intersuola con protezione contro la penetrazione di chiodi. Traspiranti e leggere forniscono un'ammortizzazione di lunga durata gestendo l'umidità. Dotate di intersuola in EVA leggera e suola in gomma antiscivolo. Il sistema di allacciatura BOA® permette di infilare e sfilare le scarpe con facilità.



Cod.	Numero	Colore	UM	€
3041530	40	NERO/GRIGIO	CP	
3041531	41	NERO/GRIGIO	CP	
3041532	42	NERO/GRIGIO	CP	
3041533	43	NERO/GRIGIO	CP	
3041534	44	NERO/GRIGIO	CP	
3041535	45	NERO/GRIGIO	CP	
3041536	46	NERO/GRIGIO	CP	



Scarpa Orca Bay Maine Russet

Mocassino Maine Russet in pelle marina.
Suola in gomma bianca antiscivolo e antitraccia.
Laccio in cuoio grezzo, occhielli antiruggine e tallone imbottito in EVA.



Cod.	Numero	Colore	UM	€
3019524	41	RUGGINE	CP	
3019525	42	RUGGINE	CP	
3019526	43	RUGGINE	CP	
3019527	44	RUGGINE	CP	
3019528	45	RUGGINE	CP	
3019529	46	RUGGINE	CP	
3019530	47	RUGGINE	CP	



Scarpa Orca Bay Squamish Russet

Mocassino Maine Russet in pelle marina resistente al sale.
Suola in gomma antiscivolo e antitraccia. Laccio in cuoio grezzo e occhielli antiruggine.



Cod.	Numero	Colore	UM	€
3019533	40	RUGGINE	CP	
3019534	41	RUGGINE	CP	
3019535	42	RUGGINE	CP	
3019536	43	RUGGINE	CP	
3019537	44	RUGGINE	CP	
3019538	45	RUGGINE	CP	
3019539	46	RUGGINE	CP	
3019540	47	RUGGINE	CP	



Stivale Orca Bay Storm Sailing Boot

Stivale Orca Bay Storm Sailing Boot in pelle marina a tre strati impermeabili e traspiranti, per alte prestazioni e massimo comfort. Suola in gomma antiscivolo per una trazione eccezionale su ponti scivolosi. Per uso diporto, professionale e rimessaggio in ogni stagione. Consigli per la pulizia e la manutenzione: usare una spazzola per rimuovere eventuali detriti e risciacquare con acqua fredda o panno umido. Lasciare asciugare naturalmente. Applicare occasionalmente uno spray impermeabilizzante per proteggere la pelle e mantenerne l'impermeabilità. Dopodiché si consiglia l'applicazione di una crema nutriente trasparente per mantenere l'elasticità della pelle e lasciare asciugare.



Cod.	Numero	Colore	UM	€
3019503	39	MARRONE	CP	
3019504	40	MARRONE	CP	
3019505	41	MARRONE	CP	
3019506	42	MARRONE	CP	
3019507	43	MARRONE	CP	
3019508	44	MARRONE	CP	
3019509	45	MARRONE	CP	
3019510	46	MARRONE	CP	
3019503C	39	CARBON	CP	
3019504C	40	CARBON	CP	
3019505C	41	CARBON	CP	
3019506C	42	CARBON	CP	
3019507C	43	CARBON	CP	
3019508C	44	CARBON	CP	
3019509C	45	CARBON	CP	
3019510C	46	CARBON	CP	



Stivale Orca Bay Solent

Stivale Orca Bay Solent rivestito con strato in Neoprene di 4mm per comfort e tenuta di calore eccezionali. Impermeabile e traspirante, con suola antiscivolo in gomma premium per la massima flessibilità e durata. Per uso diporto, professionale e rimessaggio in ogni stagione.



Cod.	Numero	Colore	UM	€
3019513	39	GRAFITE	CP	
3019514	40	GRAFITE	CP	
3019515	41	GRAFITE	CP	
3019516	42	GRAFITE	CP	
3019517	43	GRAFITE	CP	
3019518	44	GRAFITE	CP	
3019519	45	GRAFITE	CP	
3019520	46	GRAFITE	CP	



SICUREZZA SPORT/ABBIGLIAMENTO/BATTELLI ALAGGIO 7

Scarpa Orca Bay Belgravia

Elegante sneaker Belgravia in pelle, leggera e comoda. Suola in gomma bianca antiscivolo e antiruggine. Laccio in tessuto, occhielli antiruggine e tallone imbottito in EVA.



Orca Bay

Cod.	Numero	UM	€
3019571	41	CP	New
3019572	42	CP	
3019573	43	CP	
3019574	44	CP	
3019575	45	CP	
3019576	46	CP	



Scarpa Donna Orca Bay Sandusky

Mocassino da donna Sandusky in pelle marina lavabile in lavatrice. Suola in gomma bianca antiscivolo e antiruggine. Laccio in cuoio grezzo, occhielli antiruggine e tallone imbottito in EVA.

Orca Bay

Cod.	Numero	Colore	UM	€
3019550	36	INDACO / BLU	CP	UK
3019551	37	INDACO / BLU	CP	
3019552	38	INDACO / BLU	CP	
3019553	39	INDACO / BLU	CP	
3019554	40	INDACO / BLU	CP	
3019555	41	INDACO / BLU	CP	
3019556	42	INDACO / BLU	CP	
3019560	36	INDACO / MAGENTA	CP	
3019561	37	INDACO / MAGENTA	CP	
3019562	38	INDACO / MAGENTA	CP	
3019563	39	INDACO / MAGENTA	CP	
3019564	40	INDACO / MAGENTA	CP	
3019565	41	INDACO / MAGENTA	CP	
3019566	42	INDACO / MAGENTA	CP	



Scarpa Orca Bay Sandusky

Mocassino Sandusky in pelle marina lavabile in lavatrice. Suola in gomma bianca antiscivolo e antiruggine. Laccio in cuoio grezzo, occhielli antiruggine e tallone imbottito in EVA.



Orca Bay

Cod.	Numero	Colore	UM	€
3019541	41	GRIGIO / INDACO	CP	UK
3019542	42	GRIGIO / INDACO	CP	
3019543	43	GRIGIO / INDACO	CP	
3019544	44	GRIGIO / INDACO	CP	
3019545	45	GRIGIO / INDACO	CP	
3019546	46	GRIGIO / INDACO	CP	
3019547	47	GRIGIO / INDACO	CP	



- JOBE SCARPE -

Scarpa Jobe Aqua Shoes

Scarpa Jobe ideale per tutti gli sport acquatici, per le attività nautiche e per la spiaggia. Costruzione in Neoprene da 2 mm presagomato con suola a profilo sottile per un controllo ottimale della posizione. Complete con laccio elastico per caviglie.



Cod.	Numero	Colore	UM	€
3019230	37	NERO	CP	UK
3019231	38/39	NERO	CP	
3019232	40/41	NERO	CP	
3019233	42	NERO	CP	
3019234	43	NERO	CP	
3019235	44	NERO	CP	
3019236	45	NERO	CP	



Scarpa Jobe Discover Slip-On

Scarpa Jobe ideale per tutti gli sport acquatici, per le attività nautiche e per la spiaggia. Costruzione in materiale antispruzzo, confortevole ed elastico con soletta interna in EVA resistente all'acqua e suola esterna in gomma per un grip ottimale.



Cod.	Numero	Colore	UM	€
3019220	37	NERO	CP	UK
3019221	38	NERO	CP	
3019222	39	NERO	CP	
3019223	40	NERO	CP	
3019224	41	NERO	CP	
3019225	42	NERO	CP	
3019226	43	NERO	CP	
3019227	44	NERO	CP	
3019228	45	NERO	CP	



Copri Scarpa Fendress Soft

Copri scarpa Fendress in 100% Acrilico lavabile in lavatrice. Fabbricati con lo stesso tessuto morbido e robustissimo dei copriparabordi. Perfetti per muoversi a bordo senza togliere le scarpe e per proteggere il ponte.



Cod.	Numero	Colore	UM	€
3019101	35<>38	BLUE NAVY	CP	UK
3019102	39<>41	BLUE NAVY	CP	
3019103	42<>43	BLUE NAVY	CP	
3019104	44+	BLUE NAVY	CP	



Zaino Impermeabile Aquapac Daysack

Zaino impermeabile molto robusto in tessuto rinforzato di Nylon 500D spalmato PVC. La costruzione interamente saldata garantisce un isolamento completo dall'acqua. Cinghie e imbottiture in rete traspirante. Adatto per qualsiasi tipo di utilizzo.

Cod.	Ref	Colore	Capacità Lt	Dim cm	UM	€
3030475	791	LIME	28	47 x 24 x 20	PZ	
3030476	792	BLUE	28	47 x 24 x 20	PZ	



Sacca Impermeabile Aquapac Drybag

Sacca impermeabile molto robusta in tessuto rinforzato di Nylon 500D spalmato PVC. Adatta per contenere qualsiasi carico e per qualsiasi tipo di utilizzo.

Cod.	Ref	Colore	Capacità Lt	Dim cm	UM	€
3030460	731	LIME	7	28 x 16	PZ	
3030461	732	BLUE	7	28 x 16	PZ	
3030462	733	LIME	15	33 x 22	PZ	
3030463	734	BLUE	15	33 x 22	PZ	
3030464	735	LIME	25	50 x 24	PZ	
3030465	736	BLUE	25	50 x 24	PZ	



Sacca Impermeabile Aquapac Drysack

Sacca totalmente impermeabile semi trasparente in Nylon 75D rivestito in Silicone. Comoda e leggerissima, con maniglie su entrambi i lati. Utile per custodire all'interno altri contenitori, effetti personali oppure oggetti che possono perdere liquidi.

Cod.	Ref	Capacità Lt	Dim cm	UM	€
3030470	002	2	21 x 11	PZ	
3030471	004	4	24 x 15	PZ	
3030472	008	8	30 x 16	PZ	
3030473	013	13	35 x 20	PZ	



Sacca Impermeabile Aquapac First Aid Kit

Sacca impermeabile molto robusta in tessuto rinforzato di Nylon 500D spalmato PVC. Perfetta per il kit di pronto soccorso. Adatta per gli sport acquatici, il canottaggio, la vela e le escursioni.

Cod.	Ref	Capacità Lt	Dim cm	UM	€
3030485	174	3	23 x 15	PZ	



Busta Impermeabile Aquapac Keymaster

Custodia stagna fino a 10m di profondità per proteggere gli effetti personali come carte di credito, banconote, chiavi e monete. Completa di laccio.

C = Circonferenza interna.

Cod.	Ref	Colore	Dim mm	C mm	UM	€
3030310	608	GRIGIO	170 x 85	155	PZ	
3030317 	604	BLU	170 x 85	155	PZ	



Busta Impermeabile Aquapac Whanganui

Custodia stagna fino a 10 m di profondità per proteggere gli effetti personali come carte di credito, banconote, chiavi e monete. Completa di laccio.

C = Circonferenza interna.

Cod.	Ref	Dim mm	C mm	UM	€
3030315	654	265 x 138	155	PZ	



Marsupio Impermeabile Aquapac

Marsupio impermeabile fino a 10 m di profondità. Protegge effetti personali come carte di credito, banconote, chiavi e monete. Galleggiante, costruito con cuciture saldate.

C = circonferenza interna.

Cod.	Ref	H interna mm	C mm	UM	€
3030316	828	185	265	PZ	



Busta Impermeabile Aquapac Map

Custodia stagna per proteggere mappe, cartine o qualsiasi altro documento. Le estremità sono rinforzate con fascia rigida forata per agganciare il laccio (compreso). Chiusura roll stagna con Velcro.

Cod.	Ref	Dim mm	UM	€
3030311	808	330 x 310	PZ	

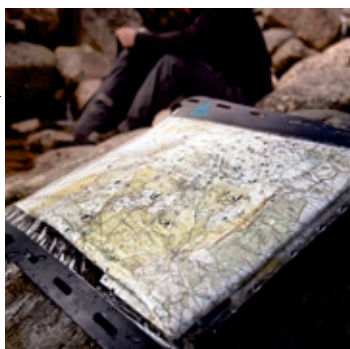

Busta Impermeabile Aquapac Pad

Custodia stagna fino a 10 m di profondità per pad, notepad, iPad e lettori kindle. La doppia lente Lenzlex permette di effettuare foto e video dentro o fuori dall'acqua garantendo ottime prestazioni e una totale sicurezza al pad. Utilizzo garantito di tutti i tasti e del touchscreen anche attraverso la custodia. Dotata di tracolla. La versione F contiene più schiuma per una maggiore protezione.

C = circonferenza interna.

Cod.	Ref	Dim mm	H interna mm	C mm	UM	€
3030308	658F - Mini	210 x 150	200	285	PZ	
3030306	669F - Standard	250 x 185	240	350	PZ	



Busta Impermeabile Aquapac Phone

Custodia stagna fino a 10 m di profondità per smartphone. La doppia lente Lenzlex permette di effettuare foto e video dentro o fuori dall'acqua garantendo ottime prestazioni e una totale sicurezza allo smartphone. Utilizzo garantito del telefono, di tutti i tasti e del touchscreen anche attraverso la custodia. Dotata di tracolla C = circonferenza interna.

Cod.	Ref	Colore	Dim mm	H interna mm	C mm	UM	€
3030301	353	VERDE	195 x 115	160	205	PZ	
3030302	354	BLU	195 x 115	160	205	PZ	
3030303	358	GRIGIO	195 x 115	160	205	PZ	



Busta Impermeabile Aquapac Phone Plus

Custodia stagna fino a 10 m di profondità per smartphone. La doppia lente Lenzlex permette di effettuare foto e video dentro o fuori dall'acqua garantendo ottime prestazioni e una totale sicurezza allo smartphone. Utilizzo garantito del telefono, di tutti i tasti e del touchscreen anche attraverso la custodia. Dotata di tracolla. C = circonferenza interna.

Cod.	Ref	Colore	Dim mm	H interna mm	C mm	UM	€
3030360	363	VERDE	215 x 130	185	240	PZ	
3030361	368	GRIGIO	215 x 130	185	240	PZ	



Busta Impermeabile Aquapac Phone Da Braccio

Custodia da braccio per smartphone, impermeabile fino a 10m di profondità. Facile da indossare, permette di avere sempre con sé il proprio smartphone, GPS o VHF in tutte le attività sportive. Consente di utilizzare il telefono in tutte le sue funzionalità senza problemi. C = circonferenza interna.

Cod.	Ref	H interna mm	C mm	UM	€
3030345	218	180	190	PZ	



Busta Impermeabile Aquapac VHF

Custodia stagna fino a 10m di profondità per VHF. Non crea interferenze con la ricezione o trasmissione del segnale e l'utilizzo di tutti i tasti è garantito attraverso la custodia. Completa di laccio. C = circonferenza interna.

Cod.	Ref	H interna mm	C mm	UM	€
3030323	208	270	170	PZ	
3030321	228	175	195	PZ	
3030322	248	225	225	PZ	



Sacca Impermeabile Aquapac Stormproof VHF

Sacca stagna molto robusta in tessuto rinforzato di Nylon 70D spalmato PVC per VHF. Con finestra trasparente per un facile utilizzo della radio. Galleggia con aria all'interno, impermeabile agli spruzzi pesanti e resistente ai raggi UV. Completa di tracolla regolabile da 25mm x 135cm. C = circonferenza interna.

Cod.	Ref	Dim mm	C mm	UM	€
3030330	214	350 x 110	195	PZ	



SICUREZZA SPORT/ABBIGLIAMENTO/BATTELLI ALAGGIO

Set 3 Pz Buste Yellow Baggy

3 buste portaoggetti impermeabili e galleggianti. Attenzione:

- Non adatte ai bambini, non adatte per immersioni
- Controllare la busta prima dell'uso
- Evitare di inserire oggetti appuntiti
- Evitare l'esposizione prolungata al sole

Dimensioni: 12x15/18x24/27x33 cm

Cod.	UM	€
3030355	CF	



Busta Water Baggy

Busta protettiva impermeabile e galleggiante. Ideale per smartphone, macchine fotografiche, schede o carte di credito.

Cod.	Dim cm	UM	€
3030440	11 x 16	PZ	



Busta Sealed Pack

Busta impermeabile porta oggetti in PVC doppio strato. L'effetto imbottitura preserva meglio gli oggetti al suo interno.

Cod.	Dim cm	UM	€
3030201	10 x 14	PZ	



Sacca Impermeabile Hanger

Sacca a chiusura stagna in tessuto di Nylon spalmato PVC.

Cod.	Capacità Lt	Dim cm	UM	€
3030253	25	30 x 90	PZ	



Sacca Impermeabile Euro Sacs

Sacca a chiusura stagna in Poliестere spalmato PVC.

Cod.	Capacità Lt	Dim cm	UM	€
3030401	20	33 x 56	PZ	
3030403	40	45 x 57	PZ	
3030404	60	45 x 75	PZ	



Contenitori Cilindrici Stagni

Contenitori cilindrici stagni per riporre in sicurezza fuochi da segnalazione, medicinali, effetti personali etc. Diametro collo 127 mm.

Cod.	Capacità Lt	ø cm	Altezza cm	UM	€
3030806	6	24	19,5	PZ	
3030808	8	24	26	PZ	
3030812	12	24	38	PZ	
3030815	15	24	44	PZ	



**Boa Segnalazione Sub**

Boe gonfiabili per segnalare la posizione di subacquei in immersione.

Cod.	Ref	ø mm	L mm	UM	€
3821130	Mini	300		PZ	
3821138	Eco	380		PZ	
3821139	Exp	380		PZ	
3821187	Long	280	880	PZ	

**Palloni Subacquei di Sollevamento**

Palloni subacquei di sollevamento completi di treccia, maniglioni, grilli inox e valvola. Costruiti in resistente Polyplan da 640 g/mq (30<->200 Kg) e in Complplan da 900 g/mq (1500<->2500 Kg).

Cod.	Capacità sollevamento Kg	Dim campane cm	Dim fascia cm	UM	€
3821402	30	60 x 35	140 x 30	PZ	
3821405	50	68 x 43	160 x 30	PZ	
3821406	100	75 x 50	180 x 52	PZ	
3821407	200	75 x 65	190 x 65	PZ	
3821408	500	97 x 74	240 x 72	PZ	
3821410	1000	130 x 100	320 x 100	PZ	
3821415	1500	146 x 100	350 x 100	PZ	
3821420	2000	180 x 150	447 x 150	PZ	
3821425	2500	220 x 150	520 x 150	PZ	



- FISHWATCHING -

Infinity Seascooter Jobe Kit

Infinity Seascooter Jobe è uno scooter subacqueo elettrico a batteria per immersioni fino a 30 m di profondità e con un'autonomia di 40 minuti a batteria. Dal design fluttuante è auto galleggiante. Con 3 livelli di velocità fino a 5 Km/h e attacco action cam. Completo di 2 batterie Li-ion, sacca impermeabile e kit snorkeling. Tempo ricarica: 4 ore a batteria.

Cod.	Dim cm	Peso Kg	UM	€
3008000	53 x 21 x 17	3,5	PZ	

JOBE
WATERSPORTS
Brabus Seascooter Jobe Kit

Brabus Seascooter Jobe è uno scooter subacqueo elettrico a batteria per immersioni fino a 30 m di profondità e con un'autonomia di 40 minuti a batteria. Dal design fluttuante è auto galleggiante. Con 3 livelli di velocità fino a 5 Km/h e attacco action cam. Completo di 2 batterie Li-ion, sacca impermeabile e kit snorkeling. Tempo ricarica: 4 ore a batteria.

Cod.	Dim cm	Peso Kg	UM	€
3008001	53 x 21 x 17	3,5	PZ	

JOBE
WATERSPORTS
Baticopio Base

Baticopio economico per osservare il fondale marino. Vetro in Plexiglass.

Cod.	Dim cm	H cm	UM	€
5310041	17 x 20	41	PZ	

**Baticopio Kristal**

Baticopio professionale per osservare il fondale marino con Vetro in Plexiglass. Smontabile per un facile stivaggio.

Cod.	ø cm	H cm	UM	€
5310051	33,5	51	PZ	



Boa Segnaletica Cilindrica Gigante

Boe da regata gonfiabili in Poliestere 1000D spalmato PVC molto resistente e robusto. Dotate di valvola di gonfiaggio e sgonfiaggio veloce e di 5 anelli in Acciaio Inox alla base che garantiscono un fissaggio al piombo sicuro e resistente a qualunque condizione meteo. Non necessitano di alcuna rete data la robustezza del materiale. Complete di maniglie per un facile trasporto e posizionamento e di 3 tasche in PVC per l'esposizione di eventuali messaggi pubblicitari.

Gonfiatore compatto e veloce opzionale codice 2930080.

Cod.	ø cm	H cm	Colore	UM	€
3821230	100	150	GIALLO	PZ	
3821231	100	150	ARANCIO	PZ	
3821235	150	150	GIALLO	PZ	
3821236	150	150	ARANCIO	PZ	

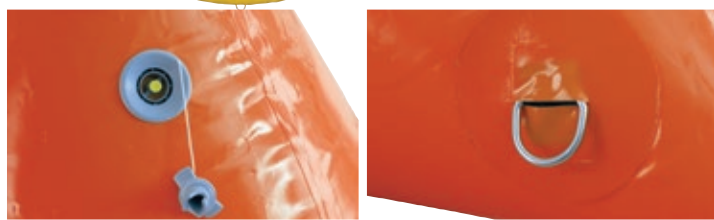
**Boa Segnaletica Triangolare Gigante**

Boe da regata gonfiabili in Poliestere 1000D spalmato PVC molto resistente e robusto. Dotate di valvola di gonfiaggio e sgonfiaggio veloce e di 7 anelli in Acciaio Inox alla base che garantiscono un fissaggio al piombo sicuro e resistente a qualunque condizione meteo. Non necessitano di alcuna rete data la robustezza del materiale. Complete di maniglie per un facile trasporto e posizionamento e di 3 tasche in PVC per l'esposizione di eventuali messaggi pubblicitari.

Gonfiatore compatto e veloce opzionale codice 2930080.

Cod.	Lati cm	Colore	UM	€
3821215	150 x 150 x 150	GIALLO	PZ	
3821216	150 x 150 x 150	ARANCIO	PZ	
3821220	200 x 200 x 200	GIALLO	PZ	
3821221	200 x 200 x 200	ARANCIO	PZ	

**Boa Segnaletica Standard**

Boe da segnalazione in Vinile per regate veliche e motonautiche.

Cod.	ø cm	H cm	Colore	UM	€
3821250	50	100	GIALLO	PZ	
3821251	50	100	ARANCIO	PZ	
3821280	80	120	GIALLO	PZ	
3821281	80	120	ARANCIO	PZ	



Coltello Microsub Race (15049)

Coltello Sub compatto con tagliacima completo di fodero e cinghie. Lama in Acciaio Inossidabile Nitrogeno W1.4060. Dopo l'uso lavare la lama con acqua dolce e ingrassarla.



Cod.	Manico	Lama cm	UM	€
5830006	Nero	6	PZ	

**Coltello Apnea 9**

Coltello sub compatto con tagliacima e foro gira-grilli. Il manico in Acciaio Inox e lo spessore ridotto di soli 4 mm lo rendono un coltello perfetto per sub. Completo di fodero e cinghie. Lama in Acciaio Inossidabile W1.4116. Dopo l'uso sciacquare la lama con acqua dolce e ingrassarla.

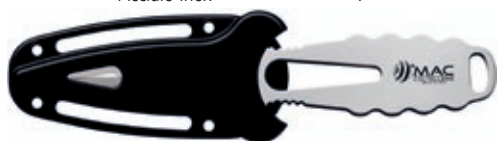

Cod.	Manico	Lama cm	UM	€
5830008	Acciaio Inox	7	PZ	

**Coltello Shark 9**

Coltello Sub compatto con tagliacima, fodero e cinghie. Lama in Acciaio Inossidabile W1.4028. Dopo l'uso lavare la lama con acqua dolce e ingrassarla.



Cod.	Manico	Lama cm	UM	€
5830009	Blue	9	PZ	
5830009G	Giallo	9	PZ	

**Coltello Shark 9/PT**

Coltello Sub compatto senza punta con tagliacima, fodero e cinghie. Lama in Acciaio Inossidabile W1.4028. Dopo l'uso lavare la lama con acqua dolce e ingrassarla.



Cod.	Manico	Lama cm	UM	€
5830028	Blue	8	PZ	
5830029	Nero	8	PZ	

**Coltello Sub 9**

Coltello Sub compatto classico. Completo di fodero e cinghie. Lama in Acciaio Inossidabile W1.4116. Dopo l'uso sciacquare la lama con acqua dolce e ingrassarla.



Cod.	Manico	Lama cm	UM	€
5830010	Blue	9	PZ	
5830010N	Nero	9	PZ	

**Coltello Sub 11**

Coltello Sub compatto classico. Completo di fodero e cinghie. Lama in Acciaio Inossidabile W1.4116. Dopo l'uso sciacquare la lama con acqua dolce e ingrassarla.



Cod.	Manico	Lama cm	UM	€
5830011	Nero	11	PZ	
5830011G	Giallo	11	PZ	



Coltello Sub 12

Coltello Sub con tagliaspago e giragrilli. Completo di fodero e cinghie. Lama in Acciaio Inossidabile W1.4116. Dopo l'uso sciacquare la lama con acqua dolce e ingrassarla.



Cod.	Manico	Lama cm	UM	€
5830012	Giallo	12	PZ	
5830012N	Nero	12	PZ	

**Coltello Torpedo**

Coltello Sub con manico ergonomico completo di fodero e cinghie. Lama a stiletto in Acciaio Inossidabile Nitrogeno W1.4060. Dopo l'uso lavare la lama con acqua dolce e ingrassarla.



Cod.	Manico	Lama cm	UM	€
5830013	Giallo	12	PZ	
5830014	Nero	12	PZ	

**Coltello Aquatys**

Coltello Sub compatto con martello su manico e tagliaspago. Completo di fodero e cinghie. Lama in Acciaio Inossidabile W1.4116. Dopo l'uso sciacquare la lama con acqua dolce e ingrassarla.



Cod.	Manico	Lama cm	UM	€
5830212	Nero/Blue	12	PZ	

**Coltello Squalo 15MR**

Coltello Sub professionale con tagliacima, martello su manico, fodero e cinghie. Lama in Acciaio Inossidabile W1.4116. Dopo l'uso lavare la lama con acqua dolce e ingrassarla.



Cod.	Manico	Lama cm	UM	€
5830020	Nero	14	PZ	

**Coltello Shark/M**

Coltello Sub professionale con tagliaspago e martello su manico. Completo di fodero e cinghie. Lama in Acciaio Inossidabile W1.4116. Dopo l'uso sciacquare la lama con acqua dolce e ingrassarla.



Cod.	Manico	Lama cm	UM	€
5830018	Nero	18	PZ	



Coltello Boat 0

Coltello a serramanico base. Manico in PP, lama in Acciaio Inossidabile W1.4028.



Cod.	Manico	Lama cm	UM	€
5830400	Nero	8,5	PZ	
5830400G	Giallo	8,5	PZ	

**Coltello Boat 0/B91**

Coltello a serramanico con gira-grilli, apribottiglia e cavigliera aprinodi. Manico in PP, lama in Acciaio Inossidabile W1.4028.



Cod.	Manico	Lama cm	UM	€
5830410	Nero	8,5	PZ	
5830410G <small>New</small>	Giallo	8,5	PZ	

**Coltello Boat 1**

Coltello a serramanico con bloccalama. Manico in PP e TPE, lama in Acciaio Inossidabile W1.4034.



Cod.	Manico	Lama cm	UM	€
5830401	Nero	8,5	PZ	
5830401G	Giallo	8,5	PZ	

**Coltello Boat 2**

Coltello a serramanico con bloccalama, gira-grilli, apribottiglia e cacciavite a taglio. Manico in mescola PP/TPE, lama in Acciaio Inossidabile W1.4034.



Cod.	Manico	Lama cm	UM	€
5830411	Nero	8,5	PZ	
5830411G <small>New</small>	Giallo	8,5	PZ	

**Coltello Skippy**

Coltello a serramanico con bloccalama e apribottiglia. Manico in mescola PP/TPE, lama in Acciaio Inossidabile W1.4034.



Cod.	Manico	Lama cm	UM	€
5830403	Blu	6,5	PZ	
5830403G	Giallo	6,5	PZ	

**Coltello Skipper**

Coltello a serramanico con bloccalama. Completo di gira-grilli, apribottiglia, cacciavite a taglio e cavigliera aprinodi. Manico in PP e TPE, lama in Acciaio Inossidabile W1.4419.



Cod.	Manico	Lama cm	UM	€
5830405	Giallo	8,5	PZ	
5830405B	Blu	8,5	PZ	

**Coltello Clipper 6**

Coltello a serramanico con foro gira-grilli. Manico e lama in Acciaio Inossidabile W1.4028.



Cod.	Manico	Lama cm	UM	€
5830506	Acciaio Inox	7,5	PZ	

**Coltello Clipper 3**

Coltello a serramanico in Acciaio Inossidabile. Completo di foro gira-grilli, cavigliera aprinodi e apribottiglie. Manico e lama in Acciaio Inossidabile W1.4028.



Cod.	Manico	Lama cm	UM	€
5830503	Acciaio Inox	7,5	PZ	



Tagliasagole di Sicurezza

Lama tagliasagole contornata da una protezione in Plastica. Completa di fodero. Permette di tagliare in totale sicurezza sagole e cinghie di qualsiasi tipo.



Cod.	Colore	L cm	UM	€
5830710	Nero	18,5	PZ	
5830711	Rosso	18,5	PZ	

MADE IN ITALY MAC
COLTELLERIA**Coltello Rescue 697**

Coltello di sicurezza con bloccalama. Lama seghettata di alta qualità per tagliare qualsiasi tipo di sagola. Manico in PP, lama in Acciaio Inossidabile W1.4034.



Cod.	Manico	Lama cm	UM	€
5830708	Rosso	8	PZ	

MADE IN ITALY MAC
COLTELLERIA**Coltello da Nostromo**

Coltello da nostromo con lama in Acciaio Inossidabile W1.4028. Completo di caviglia con gira-grilli e fodero in tessuto rinforzato. Manico ergonomico in PP e TPE.

MADE IN ITALY 

Cod.	Manico	Lama cm	UM	€
5830424	Giallo	13,8	PZ	

MAC
COLTELLERIA**Coltello da Nostromo Legno**

Coltello da nostromo tradizionale in legno di Mogano con caviglia, gira-grilli e fodero in cuoio lavorato. Lama in Acciaio Inossidabile W1.4116.

MADE IN ITALY 

Cod.	Manico	Lama cm	UM	€
5830426	Mogano	12,5	PZ	

MAC
COLTELLERIA**Attrezzo Milleusi BlackFox Steel**

Attrezzo milleusi in Acciaio Inox completo di astuccio. Comprende pinza, coltello, lima, cacciaviti, forbicine, punteruolo, seghetto, etc.

MADE IN ITALY 

Cod.	UM	€
5830520	PZ	

MAC
COLTELLERIA**Coltello Rescue B97**

Coltello di salvataggio galleggiante con punta arrotondata. Manico in Espanso, lama in Acciaio Inossidabile W1.4028.



Cod.	Manico	Lama cm	UM	€
5830707	Arancio	7	PZ	

MADE IN ITALY **Tenaglia Safety**

Tenaglia tagliacima di sicurezza galleggiante con molla ad apertura e blocco. Manico in PP, tenaglie in Acciaio Inossidabile W1.4028.

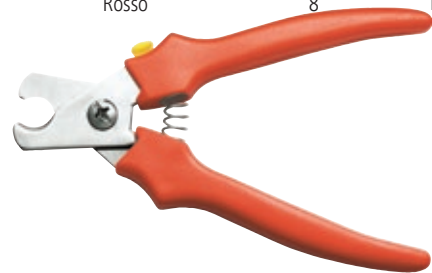

Cod.	Manico	Tenaglie cm	UM	€
5830530	Rosso	8	PZ	

MADE IN ITALY 

Coltello Oyster

Coltello per l'apertura dei molluschi. Manico in PP, lama in Acciaio Inossidabile W1.4028.

Cod.	Ref	Lama cm	UM	€
5830600	Con Paramano	6	PZ	
5830602	Senza Paramano	6	PZ	

**Coltello Fish Floating**

Coltello a serramanico galleggiante. Manico in PP, lama in Acciaio Inossidabile W1.4028.

Cod.	Manico	Lama cm	UM	€
5830607	Giallo	9	PZ	

**Coltello Fish Chef 12**

Coltello per la sfilettatura e la preparazione del pesce. Completo di fodero. Manico in PP, lama in Acciaio Inossidabile W1.4034.

Cod.	Manico	Lama cm	UM	€
5830611	Nero	12	PZ	
5830612	Giallo	12	PZ	

**Coltello Fish Wiper**

Coltello per la sfilettatura e la preparazione del pesce con squamatore. Completo di fodero. Manico in PP, lama in Acciaio Inossidabile W1.4034.

Cod.	Manico	Lama cm	UM	€
5830613	Nero	12	PZ	
5830614	Giallo	12	PZ	

**Coltello Fish Chef 18**

Coltello per la sfilettatura e la preparazione del pesce. Completo di fodero. Manico in PP, lama in Acciaio Inossidabile W1.4034.

Cod.	Manico	Lama cm	UM	€
5830618	Giallo	18	PZ	

**Cogli Ricci**

Attrezzo per cogliere ricci e qualsiasi mollusco da scoglio. Manico in PP, aggancio in Acciaio Inossidabile W1.4301.

Cod.	Manico	Lama cm	UM	€
5830620	Arancione	14	PZ	

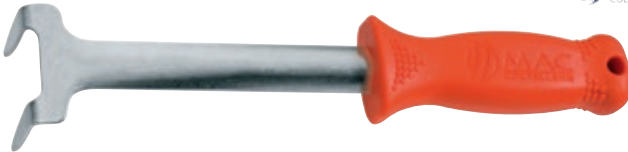
**Taglia Ricci**

Attrezzo per tagliare ricci di mare. Manico in Plastica rinforzata, lama in Acciaio Inossidabile W1.4301.

Cod.	Manico	Lama cm	UM	€
5830626	Blu	11	PZ	

**Cogli Cannolicchi**

Attrezzo per raccogliere cannolicchi. Manico in ABS, picca in Acciaio Inossidabile W1.4301.

Cod.	Manico	Lama cm	UM	€
5830622	Arancione	100	PZ	

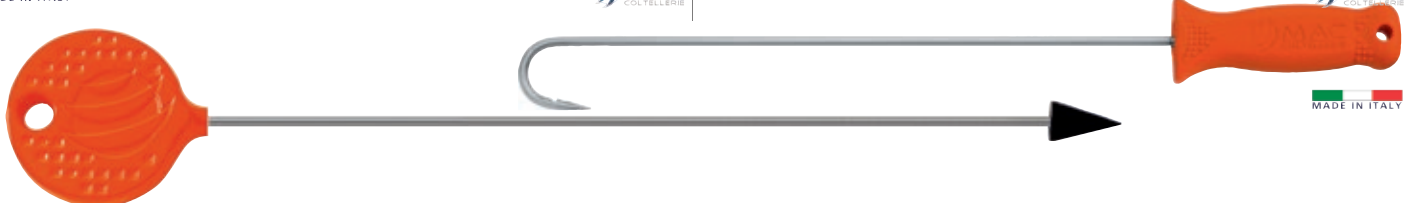
**Raffio**

Attrezzo per agganciare il pescato e tirarlo a bordo quando le dimensioni sono notevoli. Manico in Polipropilene, arpione in Acciaio Inossidabile AISI 316.

Cod.	Manico	Lama cm	UM	€
5830623	Arancione	33	PZ	
5830624	Arancione	44	PZ	
5830625	Arancione	54	PZ	

