

8

VELA FERRAMENTA /  
CORDAME COPERTURE /  
BANDIERE RIVESTIMENTI



**Grillo Dritto**

Grillo Dritto in Acciaio Inox AISI 316 stampato.

Cod.	D mm	L mm	W mm	UM	€
0121515	4	15	10	PZ	
0121517	5	17	12	PZ	
0121524	4	20	10	PZ	
0121525	5	24	16	PZ	
0121526	5	25	14	PZ	
0121542	6	23	16	PZ	

**Grillo Lungo**

Grillo Dritto in Acciaio Inox AISI 316 stampato.

Cod.	D mm	L mm	W mm	UM	€
0121540	5	36	16	PZ	
0121543	6	40	14	PZ	
0121544	8	42	18	PZ	

**Grillo Torto**

Grillo Torto in Acciaio Inox AISI 316 stampato.

Cod.	D mm	L mm	W mm	UM	€
0121552	5	22	12	PZ	
0121557	6	36	14	PZ	

**Grillo Dritto HS Stretto**

Grillo Dritto HS stretto in Acciaio Inox AISI 316 stampato. Testati nel carico di lavoro (WL). Il carico di rottura (BL) è 4 volte il carico di lavoro.

Cod.	D mm	L mm	W mm	WL Kg	UM	€
0121614	4	16	8	150	PZ	
0121615	5	20	8	250	PZ	
0121616	5	22	12	275	PZ	
0121617	6	25	13	325	PZ	

**Grillo Dritto HS Largo**

Grillo Dritto HS largo in Acciaio Inox AISI 316 stampato. Testati nel carico di lavoro (WL). Il carico di rottura (BL) è 4 volte il carico di lavoro.

Cod.	D mm	L mm	W mm	WL Kg	UM	€
0121624	4	20	10	150	PZ	
0121626	5	22	15	275	PZ	
0121627	6	25	17	325	PZ	

**Grillo Dritto Key Pin**

Grillo Dritto a scatto in Acciaio Inox AISI 316 stampato.

Cod.	D mm	L mm	W mm	UM	€
0121562	4	22	11	PZ	
0121563	5	36	15	PZ	
0121564	6	40	15	PZ	

**Grillo Dritto Key Pin B**

Grillo Dritto a scatto in Acciaio Inox AISI 316 stampato con barretta.

Cod.	D mm	L mm	L1 mm	W mm	UM	€
0121573	5	21	12	15	PZ	
0121574	6	25	12	15	PZ	
0121575	8	26	12	20	PZ	

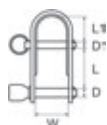

**Grillo Dritto**

Grillo Dritto in Acciaio Inox AISI 316.

Cod.	D mm	L mm	W mm	UM	€
0120004	4	16	8	PZ	
0120005	5	20	10	PZ	
0120006	6	24	12	PZ	
0120008	8	32	16	PZ	
0120010	10	40	20	PZ	
0120012	12	48	24	PZ	
0120014	14	56	28	PZ	
0120016	16	64	32	PZ	

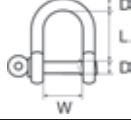

**Grillo Dritto Asse Imperdibile**

Grillo Dritto in Acciaio Inox AISI 316 con asse imperdibile.

Cod.	D mm	L mm	W mm	UM	€
0120104	4	16	8	PZ	
0120105	5	20	10	PZ	
0120106	6	24	12	PZ	
0120108	8	32	16	PZ	
0120110	10	40	20	PZ	

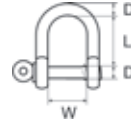

**Grillo Omega**

Grillo Omega in Acciaio Inox AISI 316.

Cod.	D mm	L mm	W mm	UM	€
0120505	5	16	9	PZ	
0120506	6	21	12	PZ	
0120508	8	27	16	PZ	
0120510	10	33	20	PZ	
0120512	12	40	23	PZ	
0120514	14	51	27	PZ	
0120516	16	60	32	PZ	



**Grillo Omega Asse Imperdibile**

Grillo Omega in Acciaio Inox AISI 316 con asse imperdibile.

Cod.	D mm	L mm	W mm	UM	€
0120545	5	25	10	PZ	
0120546	6	30	12	PZ	
0120548	8	40	16	PZ	
0120550	10	50	20	PZ	

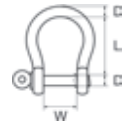

**Grillo Lungo**

Grillo Lungo in Acciaio Inox AISI 316.

Cod.	D mm	L mm	W mm	UM	€
0120804	4	32	8	PZ	
0120805	5	40	10	PZ	
0120806	6	48	12	PZ	
0120808	8	64	16	PZ	
0120810	10	80	20	PZ	

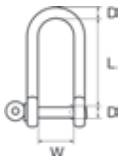

**Grillo Lungo Asse Imperdibile**

Grillo Lungo in Acciaio Inox AISI 316 con asse imperdibile.

Cod.	D mm	L mm	W mm	UM	€
0120704	4	32	8	PZ	
0120705	5	40	10	PZ	
0120706	6	48	12	PZ	
0120708	8	64	16	PZ	

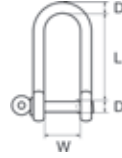

**Grillo Largo**

Grillo Largo in Acciaio Inox AISI 316.

Cod.	D mm	L mm	W mm	UM	€
0121106	6	36	24	PZ	
0121108	8	36	28	PZ	
0121110	10	60	40	PZ	
0121112	12	72	48	PZ	

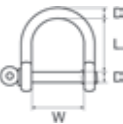

**Grillo Torto**

Grillo Torto in Acciaio Inox AISI 316.

Cod.	D mm	L mm	W mm	UM	€
0121005	5	30	10	PZ	
0121006	6	36	12	PZ	
0121008	8	40	16	PZ	
0121010	10	50	20	PZ	

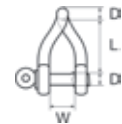

**Grillo Lungo Key Pin**

Grillo Lungo in Acciaio Inox AISI 316 a scatto con asse imperdibile.

Cod.	D mm	L mm	W mm	UM	€
0120905	5	40	13	PZ	
0120906	6	45	16	PZ	
0120908	8	64	22	PZ	



**Grillo Lungo Key Pin B**

Grillo Lungo in Acciaio Inox AISI 316 con asse imperdibile e barretta.

Cod.	D mm	L mm	W mm	UM	€
0120915	5	40	13	PZ	
0120916	6	45	16	PZ	
0120918	8	64	22	PZ	



**Grillo Dritto Wichard**

Grillo Dritto in Acciaio Inox AISI 316 Wichard con asse autobloccante. Testato e garantito nel carico di rottura (BL).

Cod.	D mm	L mm	W mm	BL Kg	UM	€
3521004	4	13	8	700	PZ	
3521005	5	16	10	1000	PZ	
3521006	6	20	12	1600	PZ	
3521008	8	26	16	2700	PZ	
3521010	10	33	20	4300	PZ	
3521012	12	39	24	6000	PZ	

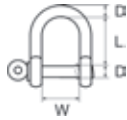

**Grillo Dritto Asse Imperdibile Wichard**

Grillo Dritto in Acciaio Inox AISI 316 Wichard con asse imperdibile autobloccante. Testato e garantito nel carico di rottura (BL).

Cod.	D mm	L mm	W mm	BL Kg	UM	€
3521024	4	13	8	1000	PZ	
3521025	5	16	10	1500	PZ	
3521026	6	20	12	2200	PZ	
3521028	8	26	16	3600	PZ	
3521030	10	33	20	5200	PZ	

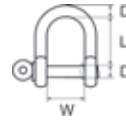

**Grillo Omega Wichard**

Grillo Omega in Acciaio Inox AISI 316 Wichard con asse autobloccante. Testato e garantito nel carico di rottura (BL).

Cod.	D mm	L mm	W mm	BL Kg	UM	€
3521204	4	18	8	700	PZ	
3521205	5	23	10	1000	PZ	
3521206	6	28	12	1600	PZ	
3521208	8	37	16	2700	PZ	
3521210	10	47	20	4300	PZ	
3521212	12	55	24	6000	PZ	



**Grillo Omega Asse Imperdibile Wichard**

Grillo Omega in Acciaio Inox AISI 316 Wichard con asse imperdibile autobloccante. Testato e garantito nel carico di rottura (BL).

Cod.	D mm	L mm	W mm	BL Kg	UM	€
3521224	4	18	8	1000	PZ	
3521225	5	23	10	1500	PZ	
3521226	6	28	12	2200	PZ	
3521228	8	37	16	3700	PZ	
3521230	10	47	20	5200	PZ	

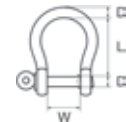

**Grillo Lungo Wichard**

Grillo Lungo in Acciaio Inox AISI 316 Wichard con asse autobloccante. Testato e garantito nel carico di rottura (BL).

Cod.	D mm	L mm	W mm	BL Kg	UM	€
3521104	4	22	8	700	PZ	
3521105	5	29	10	1000	PZ	
3521106	6	33	12	1600	PZ	
3521108	8	45	16	2700	PZ	
3521110	10	55	20	4300	PZ	

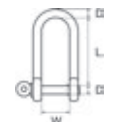

**Grillo Lungo Asse Imperdibile Wichard**

Grillo Lungo in Acciaio Inox AISI 316 Wichard con asse imperdibile autobloccante. Testato e garantito nel carico di rottura (BL).

Cod.	D mm	L mm	W mm	BL Kg	UM	€
3521124	4	31	8	1000	PZ	
3521125	5	39	10	1500	PZ	
3521126	6	46	12	2200	PZ	
3521128	8	62	16	3600	PZ	

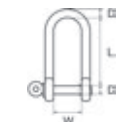

**Grillo Torto Wichard**

Grillo Torto in Acciaio Inox AISI 316 Wichard con asse autobloccante. Testato e garantito nel carico di rottura (BL).

Cod.	D mm	L mm	W mm	BL Kg	UM	€
3521305	5	26	10	1100	PZ	
3521306	6	30	12	1500	PZ	
3521308	8	40	16	3000	PZ	

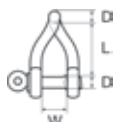

**Grillo Torto Asse Imperdibile Wichard**

Grillo Torto in Acciaio Inox AISI 316 Wichard con asse imperdibile autobloccante. Testato e garantito nel carico di rottura (BL).

Cod.	D mm	L mm	W mm	BL Kg	UM	€
3521325	5	38	10	1500	PZ	
3521326	6	44	12	2100	PZ	
3521328	8	59	16	3700	PZ	

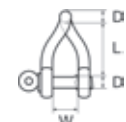

**Grillo Lungo Key Pin Wichard**

Grillo Lungo in Acciaio Inox AISI 316 Wichard a scatto con asse imperdibile. Testato e garantito nel carico di rottura (BL).

Cod.	D mm	L mm	W mm	BL Kg	UM	€
3520905	5	37	12	1100	PZ	
3520906	6	45	16	1500	PZ	
3520908	8	59	21	2300	PZ	



**Grillo Lungo Key Pin B Wichard**

Grillo Lungo in Acciaio Inox AISI 316 Wichard con asse imperdibile e barretta. Testato e garantito nel carico di rottura (BL).

Cod.	D mm	L mm	W mm	BL Kg	UM	€
3520915	5	37	12	1100	PZ	
3520916	6	45	16	1500	PZ	
3520918	8	59	21	2300	PZ	



**Grillo Dritto MTM**

Grillo Dritto in Acciaio Inox 316 di qualità superiore fornito su Card da esposizione. Carico di lavoro (WL) testato e garantito. Il carico di rottura (BL) è 4 volte il carico di lavoro.

Cod.	D mm	L mm	W mm	WL Kg	BL Kg	UM	€
0120005C	5	20	10	230	920	PZ	
0120006C	6	24	12	330	1320	PZ	
0120008C	8	32	16	600	2400	PZ	
0120010C	10	40	20	930	3720	PZ	
0120012C	12	48	24	1400	5600	PZ	
0120014C	14	56	28	1800	7200	PZ	

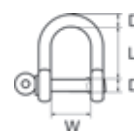

**Grillo Omega MTM**

Grillo Omega in Acciaio Inox 316 di qualità superiore fornito su Card da esposizione. Carico di lavoro (WL) testato e garantito. Il carico di rottura (BL) è 4 volte il carico di lavoro.

Cod.	D mm	L mm	W mm	WL Kg	BL Kg	UM	€
0120506C	6	21	12	330	1320	PZ	
0120508C	8	27	16	590	2370	PZ	
0120510C	10	33	20	930	3720	PZ	
0120512C	12	40	23	1370	5490	PZ	
0120514C	14	51	27	1800	7200	PZ	
0120516C	16	60	32	2440	9760	PZ	

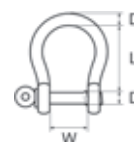

**Grillo Lungo MTM**

Grillo Lungo in Acciaio Inox 316 di qualità superiore fornito su Card da esposizione. Carico di lavoro (WL) testato e garantito. Il carico di rottura (BL) è 4 volte il carico di lavoro.

Cod.	D mm	L mm	W mm	WL Kg	BL Kg	UM	€
0120805C	5	40	10	230	920	PZ	
0120806C	6	48	12	330	1320	PZ	
0120808C	8	64	16	600	2400	PZ	
0120810C	10	80	20	930	3720	PZ	

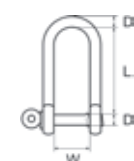

**Grillo Torto MTM**

Grillo Torto in Acciaio Inox 316 di qualità superiore fornito su Card da esposizione. Carico di lavoro (WL) testato e garantito. Il carico di rottura (BL) è 4 volte il carico di lavoro.

Cod.	D mm	L mm	W mm	WL Kg	BL Kg	UM	€
0121005C	5	30	10	230	920	PZ	
0121006C	6	36	12	330	1320	PZ	
0121008C	8	40	16	600	2400	PZ	
0121010C	10	50	20	930	3720	PZ	

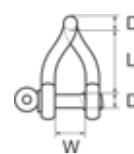

**Grillo Largo MTM**

Grillo Largo in Acciaio Inox 316 di qualità superiore fornito su Card da esposizione. Carico di lavoro (WL) testato e garantito. Il carico di rottura (BL) è 4 volte il carico di lavoro.

Cod.	D mm	L mm	W mm	WL Kg	BL Kg	UM	€
0121106C	6	36	24	330	1320	PZ	
0121108C	8	36	28	600	2400	PZ	
0121110C	10	60	40	930	3720	PZ	
0121112C	12	72	48	1400	5600	PZ	

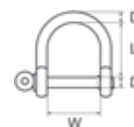

**Grillo Lungo Key Pin MTM**

Grillo Lungo a scatto con perno imperdibile in Acciaio Inox 316 di qualità superiore fornito su Card da esposizione. Carico di lavoro (WL) testato e garantito. Il carico di rottura (BL) è 4 volte il carico di lavoro.

Cod.	D mm	L mm	W mm	WL Kg	BL Kg	UM	€
0120905C	5	40	13	230	920	PZ	
0120906C	6	45	16	330	1320	PZ	
0120908C	8	64	22	600	2400	PZ	



**Grillo Lungo Key Pin B MTM**

Grillo lungo a scatto con barretta in Acciaio Inox 316 di qualità superiore fornito su Card da esposizione. Carico di lavoro (WL) testato e garantito. Il carico di rottura (BL) è 4 volte il carico di lavoro.

Cod.	D mm	L mm	W mm	WL Kg	BL Kg	UM	€
0120915C	5	40	13	230	920	PZ	
0120916C	6	45	16	330	1320	PZ	
0120918C	8	64	22	600	2400	PZ	



**Moschettone Standard**

Moschettone Standard in Acciaio Inox AISI 316.

Cod.	D mm	L mm	A mm	UM	€
0211150	5	50	8	PZ	
0211160	6	60	9	PZ	
0211170	7	70	9	PZ	
0211180	8	80	10	PZ	
0211110	10	100	12	PZ	
0211112	11	120	16	PZ	
0211114	12	140	20	PZ	
0211116	13	160	26	PZ	



**Moschettone Standard Eye**

Moschettone Standard in Acciaio Inox AISI 316 con occhio.

Cod.	D mm	L mm	A mm	O mm	UM	€
0211350	5	50	8	7.5	PZ	
0211360	6	60	9	9	PZ	
0211370	7	70	9	10	PZ	
0211380	8	80	10	11.5	PZ	
0211310	10	100	12	14	PZ	
0211312	11	120	16	16.5	PZ	
0211314	12	140	20	18	PZ	
0211316	13	160	26	20	PZ	

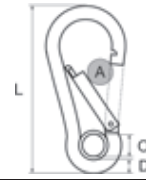

**Moschettone Side**

Moschettone in Acciaio Inox AISI 316 con grande apertura laterale. Non impiglia cavi e cime.

Cod.	D mm	L mm	A mm	UM	€
0211791	8	80	22	PZ	
0211792	10	100	24	PZ	
0211793	11	120	26	PZ	



**Moschettone Wide**

Moschettone in Acciaio Inox AISI 316 tipo largo con grande apertura.

Cod.	D mm	L mm	A mm	UM	€
0211890	6	60	10	PZ	
0211891	8	80	13	PZ	
0211892	10	100	17	PZ	
0211893	11	120	22	PZ	



**Moschettone Wide Lock**

Moschettone in Acciaio Inox AISI 316 con grande apertura e ghiera di sicurezza.

Cod.	D mm	L mm	A mm	UM	€
0211860	6	60	10	PZ	
0211880	8	80	14	PZ	
0211810	10	100	20	PZ	
0211812	11	120	24	PZ	



**Moschettone Wide Lock Eye**

Moschettone in Acciaio Inox AISI 316 con grande apertura, ghiera di sicurezza e occhio.

Cod.	D mm	L mm	A mm	O mm	UM	€
0212060	6	60	10	9	PZ	
0212080	8	80	14	11	PZ	
0212010	10	100	20	14	PZ	
0212012	11	120	24	18	PZ	



**Moschettone Standard MTM**

Moschettone Standard in Acciaio Inox 316 di qualità superiore fornito su Card da esposizione. Carico di lavoro (WL) testato e garantito. Il carico di rottura (BL) è 4 volte il carico di lavoro.



Cod.	D mm	L mm	A mm	WL Kg	BL Kg	UM	€
0211150C	5	50	8	90	360	PZ	
0211160C	6	60	9	130	520	PZ	
0211180C	8	80	10	180	720	PZ	
0211110C	10	100	12	280	1120	PZ	



**Moschettone Standard Eye MTM**

Moschettone Standard in Acciaio Inox 316 di qualità superiore con occhio fornito su Card da esposizione. Carico di lavoro (WL) testato e garantito. Il carico di rottura (BL) è 4 volte il carico di lavoro.



Cod.	D mm	L mm	A mm	O mm	WL Kg	BL Kg	UM	€
0211350C	5	50	8	7,5	90	360	PZ	
0211360C	6	60	9	9	130	520	PZ	
0211380C	8	80	10	11,5	180	720	PZ	
0211310C	10	100	12	14	280	1120	PZ	

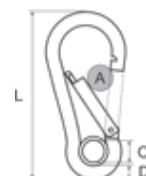

VELA FERRAMENTA/CORDAME COPERTURE/BANDIERE RIVESTIMENTI

8

**Moschettone Wide Spring**

Moschettone in Acciaio Inox A4-AISI 316 tipo largo con ampia apertura e ritorno a molla.

Cod.	D mm	L mm	A mm	UM	€
0211928	8	81	13	PZ	
0211930	10	102	15	PZ	
0211932	12	122	21	PZ	

**New****Moschettone di Sicurezza Standard**

Moschettone di sicurezza con passa cima/cinghia per cinture di sicurezza e imbracature su barche a vela. Costruzione robustissima in Acciaio Inox AISI 316.

Cod.	D mm	L mm	A mm	O mm	UM	€
0212580	8	80	14	16	PZ	
0212510	10	100	20	20	PZ	

**Moschettone Girevole Standard**

Moschettone in Acciaio Inox AISI 316 con occhio girevole.

Cod.	L mm	O mm	UM	€
0211565	68	13	PZ	
0211585	85	18	PZ	

**Moschettone Girevole Standard Bolt**

Moschettone in Acciaio Inox AISI 316 con occhiello girevole. Apertura a pistone.

Cod.	L mm	O mm	UM	€
0211506	64	10	PZ	
0211508	80	13	PZ	

**Moschettone Girevole Square Bolt**

Moschettone in Acciaio Inox AISI 316 con occhiello girevole passacinghia. Apertura a pistone.

Cod.	L mm	O mm	UM	€
0211516	61	13	PZ	
0211518	81	21	PZ	

**Moschettone Fisso Standard**

Moschettone in Acciaio Inox AISI 316 con occhio fisso.

Cod.	L mm	O mm	UM	€
0211453	53	10	PZ	
0211473	73	16	PZ	

**Moschettone con Passacinghia**

Moschettone in Acciaio Inox AISI 316 con passacinghia.

Cod.	A mm	C mm	UM	€
0211450	48	25	PZ	



**Moschettone da Fiocco Chiuso**

Moschettone da fiocco chiuso Wichard in Acciaio Inox AISI 316 forgiato. Testato e garantito nel carico di rottura (BL).



Cod.	L mm	O mm	BL Kg	UM	€
3522350	50	8	300	PZ	
3522375	75	10	700	PZ	

**Moschettone da Spi Occhio Fisso**

Moschettone da spi Wichard in Acciaio Inox AISI 316 forgiato con occhio fisso. Testato e garantito nel carico di rottura (BL).



Cod.	L mm	O mm	BL Kg	UM	€
3522550	50	10	2000	PZ	
3522570	70	13	3500	PZ	

**Moschettone da Spi Occhio Girevole**

Moschettone da spi Wichard in Acciaio Inox AISI 316 forgiato con occhio girevole. Testato e garantito nel carico di rottura (BL).



Cod.	L mm	O mm	BL Kg	UM	€
3522670	70	11	2000	PZ	
3522690	90	14	3850	PZ	

**Moschettone da Spi Occhio Girevole L**

Moschettone da spi Wichard in Acciaio Inox AISI 316 forgiato con occhio girevole. Testato e garantito nel carico di rottura (BL).



Cod.	L mm	O mm	BL Kg	UM	€
3522691	80	19	2000	PZ	
3522692	105	26	3850	PZ	

**Moschettone da Spi Grillo Girevole**

Moschettone da spi Wichard in Acciaio Inox AISI 316 forgiato con grillo girevole. Testato e garantito nel carico di rottura (BL).



Cod.	L mm	O mm	BL Kg	UM	€
3522770	70	12	1700	PZ	
3522790	90	12	3850	PZ	

**Moschettone da Spi Occhio Girevole CL**

Moschettone da spi Wichard in Acciaio Inox AISI 316 forgiato con occhio girevole. Testato e garantito nel carico di rottura (BL).



Cod.	L mm	O mm	BL Kg	UM	€
3522970	70	11	1500	PZ	
3522980	80	12	2300	PZ	
3522990	90	13,5	3200	PZ	
3522991	110	16	4800	PZ	

**Moschettone da Spi Occhio Girevole CR**

Moschettone da spi Wichard HR in Acciaio Inox AISI 316 forgiato con occhio girevole. Testato e garantito nel carico di rottura (BL).



Cod.	L mm	O mm	BL Kg	UM	€
3523090	85	11	3600	PZ	
3523091	105	16	5000	PZ	





**Moschettone da Fiocco Aperto**

Moschettone da fiocco aperto in Acciaio Inox AISI 316, utilizzato per l'attacco del fiocco su golfare di prua. Viene cucito su cinghia oppure piombato su cima, poi ribattuto.

Cod.	L mm	O mm	UM	€
022252	52	8	PZ	
022265	65	10	PZ	



**Moschettone da Fiocco Aperto MTM**

Moschettone da fiocco aperto in Acciaio Inox AISI 316 di grado superiore. Controllo e finitura per il duro uso in mare. Fornito su elegante Card da esposizione. Testato e garantito nel carico di lavoro (WL). Il carico di rottura (BL) è 4 volte il carico di lavoro.

Cod.	L mm	O mm	WL Kg	BL Kg	UM	€
022252C	50	9	90	360	PZ	
022265C	65	9	120	480	PZ	

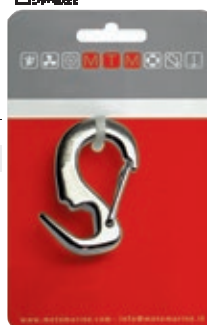

**Moschettone da Fiocco Chiuso**

Moschettone da fiocco chiuso in Acciaio Inox AISI 316, utilizzato per l'attacco del fiocco su golfare di prua. Viene cucito su cinghia oppure piombato su cima.

Cod.	L mm	O mm	UM	€
0222350	50	7	PZ	
0222370	70	9	PZ	
0222310	100	14	PZ	



**Moschettone da Fiocco Chiuso MTM**

Moschettone da fiocco chiuso in Acciaio Inox AISI 316 di grado superiore. Controllo e finitura per il duro uso in mare. Fornito su elegante Card da esposizione. Testato e garantito nel carico di lavoro (WL). Il carico di rottura (BL) è 4 volte il carico di lavoro.

Cod.	L mm	O mm	WL Kg	BL Kg	UM	€
0222350C	50	7	65	260	PZ	
0222370C	70	9	125	500	PZ	
0222310C	100	14	225	900	PZ	

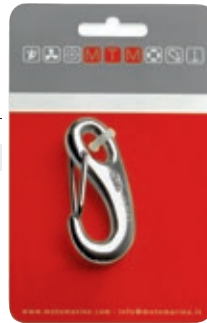

**Moschettone Spi Occhio Fisso**

Moschettone da spi fisso in Acciaio Inox AISI 316, utilizzato per le scotte e le drizze dello spinnaker o del fiocco. La scotta/drizza può essere piombata o annodata.

Cod.	L mm	O mm	UM	€
0222550	55	9	PZ	
0222560	75	12	PZ	
0222590	99	15	PZ	



**Moschettone Spi Occhio Fisso MTM**

Moschettone da spi in Acciaio Inox AISI 316 di grado superiore. Controllo e finitura per il duro uso in mare. Fornito su elegante Card da esposizione. Testato e garantito nel carico di lavoro (WL). Il carico di rottura (BL) è 4 volte il carico di lavoro.

Cod.	L mm	O mm	WL Kg	BL Kg	UM	€
0222560C	70	20	450	1800	PZ	
0222590C	100	20	830	3320	PZ	

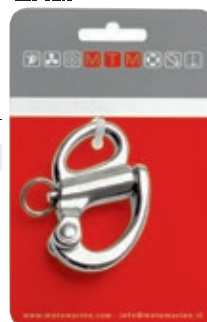

**Moschettone Spi Occhio Girevole**

Moschettone da spi girevole in Acciaio Inox AISI 316, utilizzato per le scotte e le drizze dello spinnaker o del fiocco. La scotta/drizza può essere piombata o annodata.

Cod.	L mm	O mm	UM	€
0222670	70	12	PZ	
0222690	90	16	PZ	
0222613	127	22	PZ	



**Moschettone Spi Occhio Girevole MTM**

Moschettone girevole da spi in Acciaio Inox AISI 316 di grado superiore. Controllo e finitura per il duro uso in mare. Fornito su elegante Card da esposizione. Testato e garantito nel carico di lavoro (WL). Il carico di rottura (BL) è 4 volte il carico di lavoro.

Cod.	L mm	O mm	WL Kg	BL Kg	UM	€
0222670C	70	12	160	640	PZ	
0222690C	90	16	220	880	PZ	
0222613C	127	22	400	1600	PZ	

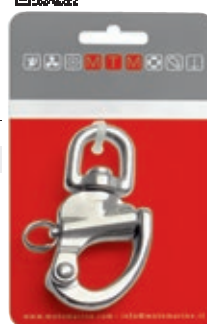

**Moschettone Spi con Grillo Girevole**

Moschettone da spi in Acciaio Inox AISI 316 con grillo girevole, utilizzato per le drizze dello spinnaker o del fiocco. Nel caso di drizze piombate, l'asse del grillo può essere facilmente sostituito se usurato.

Cod.	L mm	O mm	UM	€
0222770	74	12	PZ	
0222790	94	14	PZ	
0222713	138	22	PZ	



**Moschettone Spi con Grillo Girevole MTM**

Moschettone da spi con grillo girevole in Acciaio Inox AISI 316 di grado superiore. Controllo e finitura per il duro uso in mare. Fornito su elegante Card da esposizione. Testato e garantito nel carico di lavoro (WL). Il carico di rottura (BL) è 4 volte il carico di lavoro.

Cod.	L mm	O mm	WL Kg	BL Kg	UM	€
0222770C	74	12	160	640	PZ	
0222790C	94	12	220	880	PZ	
0222713C	138	22	400	1600	PZ	

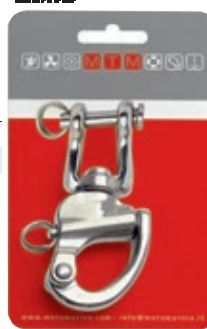

**Ponticelli in Tondino**

Ponticello lavorato in tondino di Acciaio Inox lucidato.



Cod.	D mm	W mm	W1 mm	UM	€
0333340	4	40	10	PZ	
0333350	5	51	12	PZ	
0333360	6	60	14	PZ	
0333363	8	63	15	PZ	

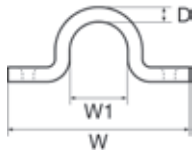

**Ponticelli Stampati L**

Ponticelli stampati in Acciaio Inox a base larga in confezioni da 10 pz.



Cod.	W mm	W1 mm	UM	€
0333213	45	13	PZ	
0333216	48	16	PZ	

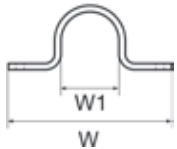

**Ponticello su Piastra Pad Eye 2**

Ponticello su piastra in Acciaio Inox con 2 fori.



Cod.	D mm	L mm	W mm	UM	€
0235045	5	45	15	PZ	
0235060	6	60	20	PZ	
0235080	8	80	26	PZ	

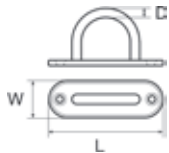

**Anello su Piastra 3 Fori H.D.**

Piastra a 3 fori con anello in Acciaio Inox da fusione. Finitura e qualità eccezionali.



Cod.	L mm	W mm	D mm	UM	€
0234346	44	44	6	PZ	
0234348	55	55	8	PZ	
0234350	73	75	10	PZ	

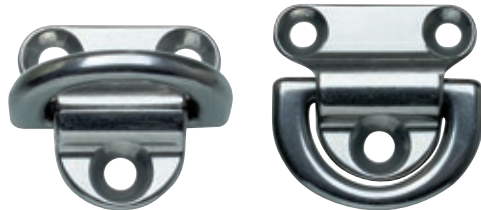
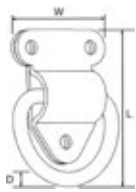

**Anello Doppio su Piastra 4 Fori HD**

Piastra a 4 fori con doppio anello in Acciaio Inox da fusione. Finitura e qualità eccezionali.



Cod.	L mm	W mm	D mm	UM	€
0234360	79	45	10	PZ	



**Ponticelli Stampati S**

Ponticelli stampati in Acciaio Inox a base stretta in confezioni da 10 pz.



Cod.	W mm	W1 mm	UM	€
0333022	38	10	PZ	
0333024	47	14	PZ	
0333026	55	20	PZ	

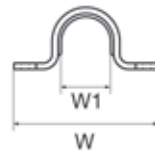

**Ponte Passacnghia**

Ponte Passacnghia lavorato in tondino di Acciaio Inox lucidato.



Cod.	D mm	W mm	W1 mm	UM	€
0333355	5	78	40	PZ	
0333362	6	92	50	PZ	

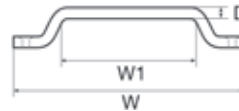

**Ponticello su Piastra Pad Eye 4**

Ponticello su piastra in Acciaio Inox con 4 fori.



Cod.	D mm	L mm	W mm	UM	€
0234035	5	35	30	PZ	
0234040	6	40	35	PZ	
0234050	8	50	40	PZ	



**Golfare su Piastra W1**

Golfare su piastra Wichard con anello abbattibile.



Cod.	L mm	W mm	D mm	Cr Kg	UM	€
3781001	40	40	6	1600	PZ	
3781002	45	45	6	2700	PZ	
3781003	57	55	8	4500	PZ	
3781004	75	75	10	9000	PZ	



**Golfare su Piastra W2**

Golfare su piastra Wichard con anelli abbattibili.



Cod.	L mm	W mm	D mm	Cr Kg	UM	€
3781012	85	45	6	2700	PZ	
3781013	95	55	8	4500	PZ	
3781014	125	75	10	10000	PZ	



**Golfare-Cavallotto U-Bolt P**

Cavallotti a U in Acciaio Inox AISI316 con tondino pizzicato.

Cod.	D mm	M mm	L mm	W mm	H mm	UM	€
0230004	3,5	4	64	30	37	PZ	
0230005	4,5	5	80	35	45	PZ	
0230006	5,2	6	90	35	45	PZ	
0230008	7,1	8	100	35	60	PZ	
0230010	9	10	130	50	75	PZ	
0230012	10,8	12	150	60	85	PZ	

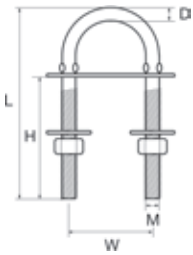

**Golfare-Cavallotto U-Bolt S**

Golfare-Cavallotto in Acciaio Inox con tondino ingrossato.

Cod.	D mm	M mm	L mm	W mm	H mm	UM	€
0230105	7	5	80	36	48	PZ	
0230106	8	6	90	36	52	PZ	
0230108	10	8	100	45	52	PZ	
0230110	12	10	130	50	72	PZ	
0230112	14	12	160	73	85	PZ	

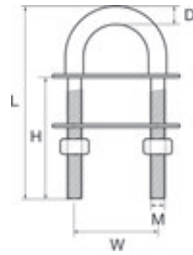

**Golfare-Cavallotto U-Bolt Roca**

Golfare-Cavallotto Roca in Acciaio Inox svedese di resistenza superiore con tondino pizzicato, due piastri e dadi autobloccanti. Finitura perfetta lucidata a specchio.

Cod.	D mm	M mm	L mm	W mm	H mm	UM	€
0230320	8	8	60	32	30	PZ	
0230321	8	8	70	32	35	PZ	
0230322	8	8	80	32	45	PZ	
0230323	8	8	90	32	55	PZ	
0230324	10	10	105	40	65	PZ	

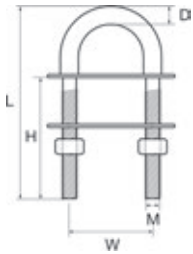

**Golfare-Cavallotto U-Bolt Coat Wichard**

Cavallotti a U Wichard in Acciaio Inox con guarnizione stagna in Gomma.

Cod.	D mm	L mm	W mm	H mm	Cr Kg	UM	€
3781225	5	60	28	30	2000	PZ	
3781226	6	90	32	55	2900	PZ	
3781228	8	100	36	60	4800	PZ	
3781230	10	110	40	65	7000	PZ	

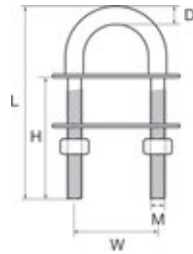

**Golfare con Occhio saldato**

Golfare Inox con perno e occhio saldato.

Cod.	D mm	M mm	W mm	H mm	Cr Kg	UM	€
0231040	6	6	13	40	1000	PZ	
0231060	6	6	13	60	1000	PZ	
0231180	8	8	17	70	1800	PZ	
0231110	10	10	21	90	2400	PZ	
0231112	12	12	25	105	3500	PZ	

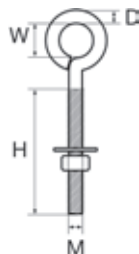

**Golfare con Occhio Tornito**

Golfare Inox con perno e occhio tornito.

Cod.	D mm	M mm	W mm	H mm	Cr Kg	UM	€
0231240	5	6	16	40	1100	PZ	
0231260	5	6	16	60	1100	PZ	
0231280	6	8	20	80	1300	PZ	
0231210	8	10	25	100	2600	PZ	
0231212	10	12	30	140	3500	PZ	

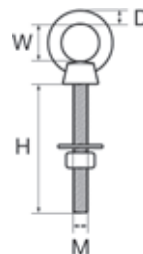

**Tenditori Modulari INOX AISI 316 MTM**

Tenditori modulari MTM in Acciaio Inox AISI 316.

I componenti del tenditore vanno acquistati separatamente per comporre la combinazione desiderata.

L = Sn (Filettatura Sinistra)

R = Ds (Filettatura Destra)

MTM

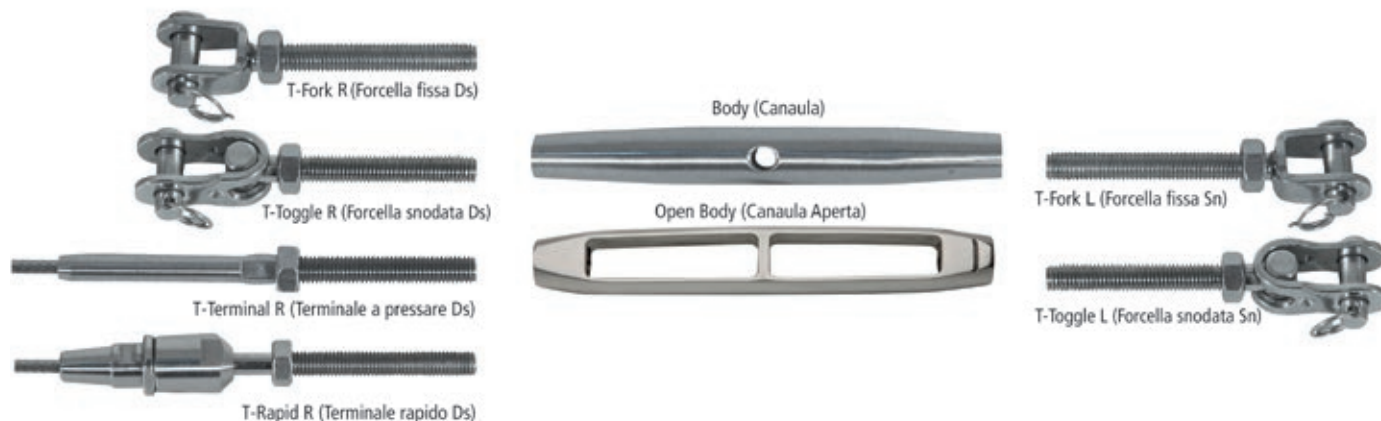

Cod.	Ref	Filettatura	L mm	Cavo ø mm	UM	€
3500025	Body (Corpo)	M5 (Sn/Ds)	80		PZ	
3500026	Body (Corpo)	M6 (Sn/Ds)	90		PZ	
3500028	Body (Corpo)	M8 (Sn/Ds)	105		PZ	
3500030	Body (Corpo)	M10 (Sn/Ds)	125		PZ	
3500032	Body (Corpo)	M12 (Sn/Ds)	150		PZ	
3500034	Body (Corpo)	M14 (Sn/Ds)	165		PZ	
3500036	Body (Corpo)	M16 (Sn/Ds)	190		PZ	
3500056	Open Body (Corpo)	M6 (Sn/Ds)	102		PZ	
3500058	Open Body (Corpo)	M8 (Sn/Ds)	121		PZ	
3500060	Open Body (Corpo)	M10 (Sn/Ds)	135		PZ	
3500062	Open Body (Corpo)	M12 (Sn/Ds)	170		PZ	
3500135	T-Fork L (Forcella fissa Sn)	M5 (Sn)	39		PZ	
3500136	T-Fork L (Forcella fissa Sn)	M6 (Sn)	50		PZ	
3500138	T-Fork L (Forcella fissa Sn)	M8 (Sn)	57		PZ	
3500140	T-Fork L (Forcella fissa Sn)	M10 (Sn)	68		PZ	
3500142	T-Fork L (Forcella fissa Sn)	M12 (Sn)	82		PZ	
3500144	T-Fork L (Forcella fissa Sn)	M14 (Sn)	95		PZ	
3500146	T-Fork L (Forcella fissa Sn)	M16 (Sn)	102		PZ	
3500225	T-Fork R (Forcella fissa Ds)	M5 (Ds)	39		PZ	
3500226	T-Fork R (Forcella fissa Ds)	M6 (Ds)	50		PZ	
3500228	T-Fork R (Forcella fissa Ds)	M8 (Ds)	57		PZ	
3500230	T-Fork R (Forcella fissa Ds)	M10 (Ds)	68		PZ	
3500232	T-Fork R (Forcella fissa Ds)	M12 (Ds)	82		PZ	
3500234	T-Fork R (Forcella fissa Ds)	M14 (Ds)	95		PZ	
3500236	T-Fork R (Forcella fissa Ds)	M16 (Ds)	102		PZ	
3500155	T-Toggle L (Forcella snodata Sn)	M5 (Sn)	42		PZ	
3500156	T-Toggle L (Forcella snodata Sn)	M6 (Sn)	48		PZ	
3500158	T-Toggle L (Forcella snodata Sn)	M8 (Sn)	56		PZ	
3500160	T-Toggle L (Forcella snodata Sn)	M10 (Sn)	67		PZ	
3500162	T-Toggle L (Forcella snodata Sn)	M12 (Sn)	81		PZ	
3500164	T-Toggle L (Forcella snodata Sn)	M14 (Sn)	89		PZ	
3500166	T-Toggle L (Forcella snodata Sn)	M16 (Sn)	103		PZ	
3500245	T-Toggle R (Forcella snodata Ds)	M5 (Ds)	42		PZ	
3500246	T-Toggle R (Forcella snodata Ds)	M6 (Ds)	48		PZ	
3500248	T-Toggle R (Forcella snodata Ds)	M8 (Ds)	56		PZ	
3500250	T-Toggle R (Forcella snodata Ds)	M10 (Ds)	67		PZ	
3500252	T-Toggle R (Forcella snodata Ds)	M12 (Ds)	81		PZ	
3500254	T-Toggle R (Forcella snodata Ds)	M14 (Ds)	89		PZ	
3500256	T-Toggle R (Forcella snodata Ds)	M16 (Ds)	103		PZ	
3500803	T-Terminal R (Terminale a pressare Ds)	M6 (Ds)	100 (48-L1)	3	PZ	
3500804	T-Terminal R (Terminale a pressare Ds)	M8 (Ds)	117 (57-L1)	4	PZ	
3500805	T-Terminal R (Terminale a pressare Ds)	M10 (Ds)	130 (63-L1)	5	PZ	
3500806	T-Terminal R (Terminale a pressare Ds)	M12 (Ds)	162 (80-L1)	6	PZ	
3500807	T-Terminal R (Terminale a pressare Ds)	M14 (Ds)	180 (90-L1)	7	PZ	
3500808	T-Terminal R (Terminale a pressare Ds)	M16 (Ds)	200 (100-L1)	8	PZ	
3500823	T-Rapid R (Terminale rapido Ds)	M6 (Ds)	86 (39-L1)	3	PZ	
3500814	T-Rapid R (Terminale rapido Ds)	M6 (Ds)	92 (45-L1)	4	PZ	
3500824	T-Rapid R (Terminale rapido Ds)	M8 (Ds)	111 (54-L1)	4	PZ	
3500825	T-Rapid R (Terminale rapido Ds)	M10 (Ds)	128 (65-L1)	5	PZ	
3500826	T-Rapid R (Terminale rapido Ds)	M12 (Ds)	162 (82-L1)	6	PZ	

**Tenditori Classici Inox AISI 316**

Tenditori classici in Acciaio Inox AISI 316 rifiniti a lucido.

Cod.	Filettatura	Cr Kg	UM	€
3500004	M4	340	PZ	
3500005	M5	560	PZ	
3500006	M6	770	PZ	
3500008	M8	1390	PZ	
3500010	M10	2180	PZ	
3500012	M12	3200	PZ	
3500014	M14	4360	PZ	
3500016	M16	5700	PZ	



MTM

**- TERMINALI E LANDE IN ACCIAIO INOX AISI 316 -****Terminali a Pressare Occhio**

Terminali a pressare in Acciaio Inox AISI 316 con occhio.

Cod.	Cavo ø mm	D mm	D1 mm	L mm	Cr Kg	UM	€
3501703	3	6,3	6,5	62	1000	PZ	
3501704	4	7,5	8,5	77	1350	PZ	
3501705	5	9,1	10,5	87	2500	PZ	
3501706	6	12,5	13,0	107	4500	PZ	
3501707	7	14,25	15	118,5	5400	PZ	
3501708	8	16,1	14,5	133	6700	PZ	



MTM

**Terminali a Pressare Forcella**

Terminali a pressare in Acciaio Inox AISI 316 con forcella.

Cod.	Cavo ø mm	D mm	L mm	Cr Kg	UM	€
3501603	3	6,3	68	1250	PZ	
3501604	4	7,5	77	1800	PZ	
3501605	5	9,1	87	2650	PZ	
3501606	6	12,5	109	4000	PZ	
3501607	7	14,25	116	5800	PZ	
3501608	8	16,1	148	6500	PZ	

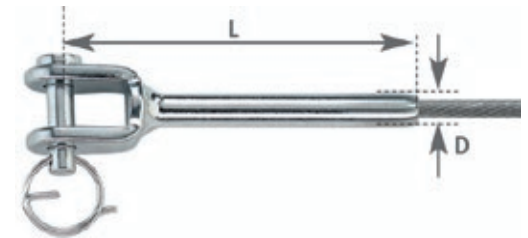

MTM

**Terminali a Pressare Snodati**

Terminali a pressare in Acciaio Inox AISI 316 con forcella snodata.

Cod.	Cavo ø mm	D mm	L mm	Cr Kg	UM	€
3501623	3	6,3	75	670	PZ	
3501624	4	7,5	89	1400	PZ	
3501625	5	9,1	104	1700	PZ	
3501626	6	12,5	127	4000	PZ	
3501628	8	16,1	163	7000	PZ	

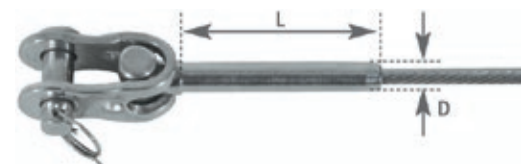

MTM

**Terminali Rapidi Occhio**

Terminali rapidi in Acciaio Inox AISI 316 con occhio. Tenuta eccezionale pari al carico di rottura del cavo. Facili da montare, basta inserire il cavo d'acciaio nel terminale e il mandrino lo cattura automaticamente. Adatti per tutti i tipi di cavi in acciaio (19/49/133 fili).

Cod.	Cavo ø mm	D mm	L mm	A mm	Cr Kg	UM	€
3500403	3	6,5	50	16	800	PZ	
3500404	4	8,5	58	18	1500	PZ	
3500405	5	10,5	70	22	2200	PZ	
3500406	6	12,5	84	25	3200	PZ	

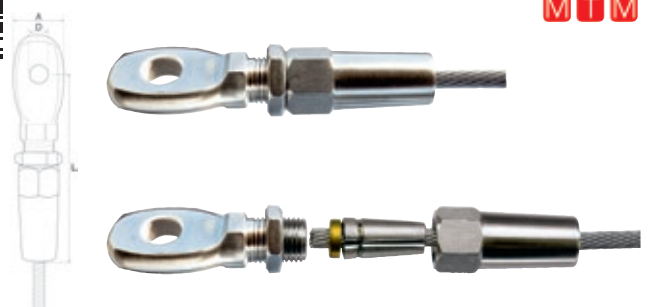

MTM

**Terminali Rapidi Forcella**

Terminali rapidi in Acciaio Inox AISI 316 con forcella. Tenuta eccezionale pari al carico di rottura del cavo. Facili da montare, basta inserire il cavo d'acciaio nel terminale e il mandrino lo cattura automaticamente. Adatti per tutti i tipi di cavi in acciaio (19/49/133 fili).

Cod.	Cavo ø mm	D mm	L mm	B mm	H mm	Cr Kg	UM	€
3500503	3	6	55	6	8	800	PZ	
3500504	4	8	62	8	8	1500	PZ	
3500505	5	10	74	10	10	2200	PZ	
3500506	6	12	89	12	12	3200	PZ	



MTM

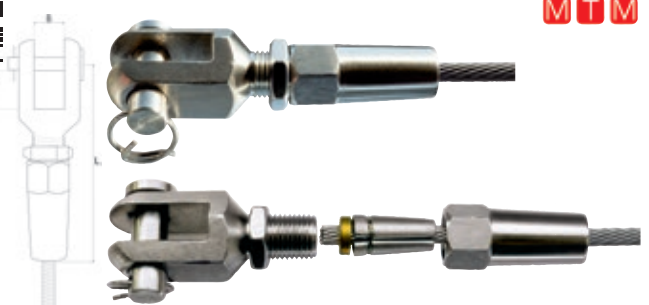

**Terminali a Pressare da Albero**

Terminali a pressare da albero in Acciaio Inox AISI 316.



Cod.	Cavo ø mm	Accessori	UM	€
3503103	3		PZ	
3503104	4		PZ	
3503105	5		PZ	
3503106	6		PZ	
3503303		Piastra albero 50 x 15 mm (terminale 3 mm)	PZ	
3503305		Piastra albero 88 x 26 mm (terminale 4/5 mm)	PZ	
3503306		Piastra albero 122 x 40 mm (terminale 6 mm)	PZ	

**Ganci Pelikan Hook**

Ganci a Pellicano con terminale a pressare in Acciaio Inox AISI 316.

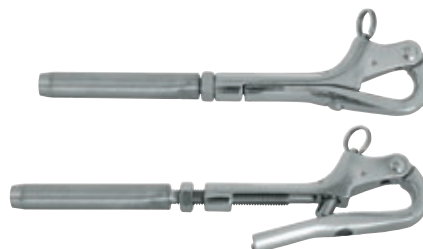

Cod.	Cavo ø mm	Filettatura	Cr Kg	UM	€
3504006	3	M6	1000	PZ	
3504008	4	M8	1500	PZ	
3504010	5	M8	1500	PZ	
3504012	6	M8	1500	PZ	

**Lande a Catena Short**

Landa forata a catena in Acciaio Inox.



Cod.	L mm	W mm	ø Fori mm	UM	€
3500108	80	14	5	PZ	
3500110	100	14	6	PZ	
3500112	120	14	6	PZ	

**Lande a Catena Long**

Landa forata a catena in Acciaio Inox.



Cod.	L mm	W mm	ø Fori mm	UM	€
3500114	150	14	6	PZ	
3500120	200	14	10	PZ	
3500111	1000	14	10	PZ	

**Tenditori Modulari Inox AISI 316 Open Body UNF**

Tenditori modulari in Acciaio Inox AISI 316 Open Body con filettatura UNF in pollici.

I componenti del tenditore vanno acquistati separatamente per comporre la combinazione desiderata.

L = Sn (Filettatura Sinistra)

R = Ds (Filettatura Destra)

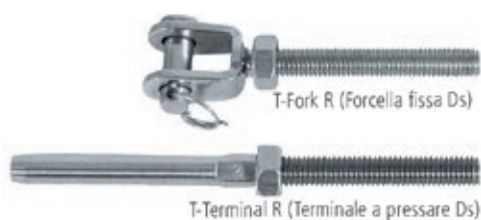

Cod.	Ref	Filettatura UNF	L mm	Cavo ø mm	UM	€
3500310	Open Body (Corpo)	1/4	102		PZ	
3500312	Open Body (Corpo)	5/16	121		PZ	
3500314	Open Body (Corpo)	3/8	135		PZ	
3500316	Open Body (Corpo)	1/2	170		PZ	
3500320	T-Fork R (Forcella fissa Ds)	1/4	50		PZ	
3500322	T-Fork R (Forcella fissa Ds)	5/16	57		PZ	
3500324	T-Fork R (Forcella fissa Ds)	3/8	68		PZ	
3500326	T-Fork R (Forcella fissa Ds)	1/2	82		PZ	
3500330	T-Toggle L (Forcella snodata Sn)	1/4	50		PZ	
3500332	T-Toggle L (Forcella snodata Sn)	5/16	57		PZ	
3500334	T-Toggle L (Forcella snodata Sn)	3/8	68		PZ	
3500336	T-Toggle L (Forcella snodata Sn)	1/2	82		PZ	
3500340	T-Terminal R (Terminale a pressare Ds)	1/4	97	3	PZ	
3500342	T-Terminal R (Terminale a pressare Ds)	5/16	115	4	PZ	
3500344	T-Terminal R (Terminale a pressare Ds)	3/8	128	5	PZ	

**Anellini di Sicurezza**

Anellini di sicurezza in Acciaio Inox.

Cod.	ø mm	UM	€
3501510	10 x 1,5	PZ	
3501514	16 x 1,5	PZ	
3501518	18 x 1,5	PZ	
3501523	22 x 1,5	PZ	

**Anellini di Sicurezza Cotter Rings**

Anellini di sicurezza in Acciaio Inox con gambetto anti sfilamento.

Cod.	ø mm	UM	€
3501411	11 x 1,0	PZ	
3501415	15 x 1,2	PZ	
3501420	20 x 1,5	PZ	
3501425	25 x 1,8	PZ	

**- DRAGLIE E CAVI PER SARTIAME -****Cavo in Acciaio Inox Plastificato per Battagliola**

Cavetto plastificato in Acciaio Inox da 19 fili rivestito con guaina bianca.

Cod.	ø Esterno mm	ø Cavo Inox mm	Rotolo m	UM	€
061650620	6	3	20	CF	
061650630	6	3	30	CF	
061650650	6	3	50	CF	
061650820	8	4	20	CF	
061650830	8	4	30	CF	
061650850	8	4	50	CF	

**Cavo Inox 19-Fili**

Cavo Inox AISI 316 da 19 fili in bobine da 50 metri. Testato e controllato di qualità superiore.

Cod.	Cavo ø mm	Carico rottura Kg	gr/m ±	UM	€
540190150	2	340	20	MT	
540190250	2,5	550	32	MT	
540190350	3	750	46	MT	
540190450	4	1400	79	MT	
540190550	5	2100	125	MT	
540190650	6	3000	178	MT	
540190750	7	4100	240	MT	
540190850	8	5400	320	MT	
540191050	10	8500	495	MT	

**Cavo Inox 49-Fili**

Cavo Inox AISI 316 da 49 fili in bobine da 50 metri. Testato e controllato di qualità superiore.

Cod.	Cavo ø mm	Carico rottura Kg	gr/m ±	UM	€
540490150	2	235	14	MT	
540490250	2,5	380	22	MT	
540490350	3	500	31	MT	
540490450	4	1000	61	MT	
540490550	5	1600	94	MT	
540490650	6	2200	133	MT	
540490850	8	4100	246	MT	
540491050	10	5200	375	MT	

**Cavo Inox 133-Fili**

Cavo Inox AISI 316 da 133 fili in bobine da 50 metri. Testato e controllato di qualità superiore.

Cod.	Cavo ø mm	Carico rottura Kg	gr/m ±	UM	€
541330150	2	250	15	MT	
541330250	2,5	350	22	MT	
541330350	3	600	40	MT	
541330450	4	950	60	MT	
541330550	5	1400	90	MT	
541330650	6	2100	138	MT	
541330850	8	3800	240	MT	
541331050	10	6000	375	MT	



**Morsetti Piatti in Acciaio Inox**

Morsetti piatti in Acciaio Inox per cavi metallici.

Cod.	Cavo ø mm	UM	€
5424222	2	PZ	
5424223	3	PZ	
5424224	4	PZ	
5424225	5	PZ	
5424226	6	PZ	

**Morsetti Piatti Doppi in Acciaio Inox**

Morsetti piatti doppi in Acciaio Inox per cavi metallici.

Cod.	Cavo ø mm	UM	€
5424232	2	PZ	
5424233	3	PZ	
5424234	4	PZ	
5424235	5	PZ	
5424236	6	PZ	

**Morsetti in Acciaio Inox**

Morsetti in Acciaio Inox per un bloccaggio rapido di cavi metallici o tessili.

Cod.	Cavo ø mm	UM	€
5424122	2	PZ	
5424123	3	PZ	
5424140	4	PZ	
5424150	5	PZ	
5424160	6	PZ	
5424180	8	PZ	
5424110	10	PZ	
5424112	12	PZ	
5424114	14	PZ	

**Manicotti in Rame per Impiombare**

Manicotti ovali in Rame per impiombare.

Cod.	Per cavo ø mm	UM	€
5424002	2	PZ	
5424003	3	PZ	
5424004	4	PZ	
5424005	5	PZ	
5424006	6	PZ	
5424008	8	PZ	

**Pinze Impiombatrici Pressamanicotti**

Pinze pressamanicotti per impiombare cavi diametro 2/2,5/3/4/5 mm.

Cod.	Tipo	L mm	UM	€
5424026	ECO	665	PZ	
5424025	PROFI	660	PZ	

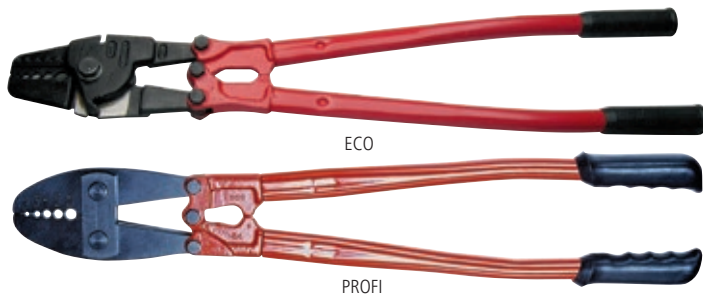

ECO

PROFI

**Pinze Tagliacavi**

Pinze tagliacavi per tondini fino a 6 mm e cavi fino a 9 mm.

Cod.	Tipo	L mm	UM	€
5424038	ECO	520	PZ	
5424035	PROFI	335	PZ	

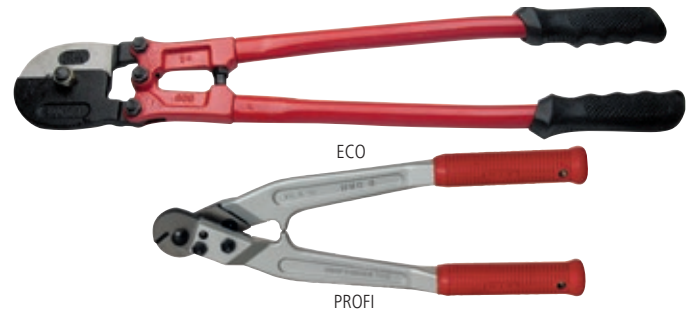

ECO

PROFI

**Redance in Plastica**

Redance in Nylon Bianco evitano che cime o cavi si logorino per l'attrito.

Cod.	Per cima ø mm	UM	€
5430004	4	PZ	
5430005	5	PZ	
5430006	6	PZ	
5430008	8	PZ	
5430010	10	PZ	
5430012	12	PZ	
5430014	14	PZ	
5430016	16	PZ	
5430018	18	PZ	
5430020	20	PZ	
5430022	22	PZ	
5430024	24	PZ	

**Redance in Acciaio Inox**

Redance in Acciaio Inox AISI 316. Impediscono che cime o cavi si logorino per l'attrito.

Cod.	Per cima ø mm	UM	€
5425001	2	PZ	
5425002	2,5	PZ	
5425003	3	PZ	
5425004	4	PZ	
5425005	5	PZ	
5425006	6	PZ	
5425008	8	PZ	
5425010	10	PZ	
5425012	12	PZ	
5425014	14	PZ	
5425016	16	PZ	
5425018	18	PZ	
5425020	20	PZ	
5425022	22	PZ	
5425024	24/26	PZ	
5425028	28/30	PZ	
5425032	32/34	PZ	
5425036	36/38	PZ	
5425040	40/42	PZ	





**Pulpito di Prua - Sail Bow**

Pulpito di prua in Acciaio Inox AISI 316 tipo Sail Bow per barche a vela.

Cod.	ø Tubo mm	H mm	Larghezza mm	Lunghezza mm	UM	€
0611645	22	450	800 (± 150)	900	PZ	
0611660	22	600	740 (± 150)	1100	PZ	

**Pulpito di Poppa - Sail Stern**

Pulpito di poppa in Acciaio Inox AISI 316 tipo Sail Stern per barche a vela. Composto da due pezzi, destro e sinistro.

Cod.	ø Tubo mm	H mm	L dietro mm	L fianco mm	Angolo	UM	€
0611745	22	450	350	400	100°	PZ	
0611760	22	600	400	430	100°	PZ	

**Tientibene di Poppa**

Passamano tientibene di poppa in Acciaio Inox con attacchi per draglie.

Cod.	ø Tubo mm	Altezza mm	Larghezza mm	UM	€
0611802	25	610	325	PZ	

**Candelieri in Acciaio Inox**

Candelieri in Acciaio Inox ø 25 mm.

Cod.	H mm	Fori	Interasse mm	UM	€
0612045	505	2	295	PZ	
0612060	610	2	300	PZ	
0612075	725	2	355	PZ	

**Basi Triangolari per Candelieri**

Basi triangolari in Acciaio Inox per candelieri. Dimensione base 95 x 95 x 77 mm.

Cod.	Per candelieri ø mm	Base	UM	€
0612525	25	Piana	PZ	
0612625	25	Inclinata a 6°	PZ	

**Basi Quadre per Candelieri**

Basi quadre in Acciaio Inox per candelieri. Dimensione base 91 x 64 mm.

Cod.	Per candelieri ø mm	Base	UM	€
0612425	25	Piana	PZ	
0612426	25	Inclinata a 6°	PZ	

**Rete Battagliola H600 mm**

Rete per battagliola H 600 mm in Poliestere 100%. Annodatura saldata la più economica, annodatura a mano la più sicura.

Cod.	Tipo	Confezione m	UM	€
3215508	Saldata a rombi	20	MT	
3215509	Saldata a rombi	30	MT	
3215510	Saldata a rombi	50	MT	
3215512	Annodata a quadrati	20	MT	
3215511	Annodata a quadrati	30	MT	
3215513	Annodata a quadrati	50	MT	



**Ruotini Save-Sail**

Ruotini di protezione per vele. Si applicano su sartiame  $\varnothing$  5 mm.  
Allargando il foro si adattano a sartiame da  $\varnothing$  fino a 10 mm. Venduti in coppia.



Cod.	Pezzi / CF	UM	€
3840105	2	CP	

**Copricrocette in PVC**

Copricrocette in morbido PVC.



Cod.	Sartie $\varnothing$ mm	Crocette $\varnothing$ mm	H mm	UM	€
3841006	5/6	28	91	PZ	
3841008	7/8	30	86	PZ	
3841010	10/12	54	120	PZ	

**Copritenditori Navishell**

Copritenditori in tessuto acrilico idrorepellente e resistente ai raggi UV.  
I colori indelebili stabilizzati restano vivaci per almeno 3 anni di utilizzo continuo.  
Il Velcro garantisce una facile e sicura applicazione.



Cod.	L cm	Colore	UM	€
3840046	37	BLUE NAVY	PZ	
3840047	47	BLUE NAVY	PZ	
3840048	61	BLUE NAVY	PZ	
3840120	37	GRIGIO	PZ	
3840121	47	GRIGIO	PZ	
3840122	61	GRIGIO	PZ	

**Copricrocette Ocean**

Copricrocette in morbido e flessibile Poliuretano per crocette da 100 a 360 mm di circonferenza. L'imbottitura a spessore assorbe urti anche importanti con barche affiancate. Corredate di fascette in nylon per un facile montaggio. Venduti in coppia.



Cod.	Dimensioni cm	UM	€
3841030	20 x 10 x 11	CP	

**Copricrocette in Pelle**

Copricrocette molto eleganti in pelle trattata. Disponibili in quattro taglie.  
Il lato interno è foderato in Neoprene per una vestibilità perfetta.  
Il copricrocette è completo di un lungo cinturino di Velcro che garantisce un fissaggio sicuro anche sulle crocette più grosse. Basta solamente tagliare il cinturino alla lunghezza adatta e montare il copricrocette con il Velcro rivolto all'interno. Vendute in coppia.



Cod.	Taglia	Crocette per sartie continue	Crocette per sartie unite	UM	€
3841042	S	55 <> 95 mm		CP	
3841043	M	95 <> 122 mm	74 <> 95 mm	CP	
3841044	L	122 <> 154 mm	105 <> 122 mm	CP	
3841046	XL		122 <> 154 mm	CP	

**FITTING TABLE**

**Fitting**

1. Measure spreader arm (in the middle, not the tip)
2. What kind of rig: Continuous or linked rig
3. Choose from table

FITTING TABLE	Continuous rig	Linked rig
55-95 mm (2 3/16" - 3 3/8")	1050 Small	
95-122 mm (3 3/8" - 4 13/16")	1052 Medium	
122-154 mm (4 13/16" - 6 1/4")	1054 Large	
122-154 mm (4 13/16" - 4")	1054 Large	1056 X-Large



**Copridraglie Columbus**

Copridraglie Columbus in tessuto esterno 600 DEN resistente ai raggi UV, interno in espanso.

Doppia chiusura in Velcro: una interna per coprire la draglia, una esterna per il fissaggio del copridraglia.

Cod.	L cm	UM	€
3840059	60	PZ	
3840060	100	PZ	

**Copridraglie Navishell**

Copridraglie Navishell in tessuto acrilico idrorepellente e resistente ai raggi UV. I colori indelebili stabilizzati restano vivaci per almeno 3 anni di utilizzo continuo. Dotati di robusta Zip per un montaggio facile e sicuro nel tempo.

Cod.	L cm	Colore	UM	€
3840041	50	BLUE NAVY	PZ	
3840042	75	BLUE NAVY	PZ	
3840043	100	BLUE NAVY	PZ	
3840044	150	BLUE NAVY	PZ	
3840110	50	GRIGIO	PZ	
3840111	75	GRIGIO	PZ	
3840112	100	GRIGIO	PZ	
3840115	150	GRIGIO	PZ	

**Copridraglie Fender-Design**

Copridraglie in materiale non assorbente rivestito in tessuto resistente ai raggi UV. Fissaggio grazie ai due lacci presenti alle estremità.

Cod.	L cm	Colore	UM	€
3840080	33	BLUE NAVY	PZ	

**Copri Candelieri Sail Defender**

Il copricandelieri protegge il genoa dal costante sfregamento sui candelieri. In morbido Poliuretano, si applica ad ogni tipo di candelieri con draglia in linea. 2 bottoni automatici assicurano una perfetta tenuta. Confezione da 4 pezzi.

Cod.	Dimensioni cm	UM	€
3841034	10 x 7 x 3,4	CF	

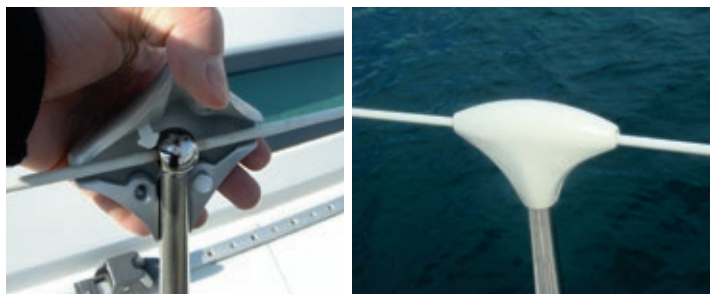
**Protezione in Pelle per Draglie**

Protezioni per terminali draglia molto eleganti in vera pelle trattata. Facile applicazione grazie alla pelle preforata, la confezione è completa di ago e filo. Vendute in coppia.

Cod.	UM	€
3841052	CP	

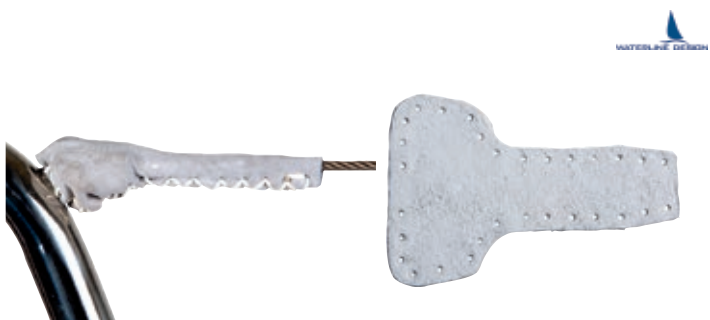
**Protezione in Pelle per Candelieri**

Protezioni per candelieri molto eleganti in vera pelle trattata. Facile applicazione grazie alla pelle preforata, la confezione è completa di ago e filo. Vendute in coppia.

Cod.	UM	€
3841054	CP	

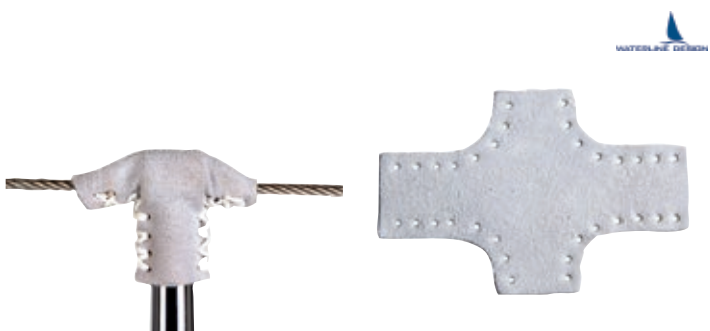

**Bozzelli Inox Outline 6MM**

Bozzelli per scottine fino a 6 mm. Cassa in Acciaio Inox, puleggia D20 mm.

Cod.	Ref	UM	€
3600000	Singolo con perno	PZ	
3600001	Singolo	PZ	
3600004	Singolo con perno estraibile	PZ	
3600006	Singolo con grillo estraibile	PZ	

**Bozzelli HS Micro 4MM**

Bozzelli HS su sfere per cavi in Acciaio e scottine in Dyneema fino a 4 mm.

Sfere, puleggia e cassa in Acciaio Inox.

Diametro puleggia 19 mm.

Carico di rottura 450 Kg.

Cod.	Ref	UM	€
3601350	Singolo	PZ	
3601362	Singolo girevole	PZ	
3601351	Singolo con arricavo	PZ	
3601353	Singolo girevole con arricavo	PZ	
3601355	Doppio	PZ	
3601354	Doppio con arricavo	PZ	
3601356	Triplo	PZ	
3601364	Triplo con strozza e arricavo	PZ	
3601365	Rinvio piano	PZ	
3601366	Rinvio su base	PZ	
3601368	Rinvio verticale	PZ	
3601371	Singolo a incasso	PZ	
3601372	Doppio a incasso	PZ	

**Bozzelli HS Micro 6MM**

Bozzelli HS su sfere per scottine fino a 6 mm.

Sfere e cassa in Acciaio Inox. Diametro puleggia 19 mm. Carico di rottura 450 Kg.

Cod.	Ref	UM	€
3601050	Singolo	PZ	
3601062	Singolo girevole	PZ	
3601051	Singolo con arricavo	PZ	
3601053	Singolo girevole con arricavo	PZ	
3601061	Violino con strozza	PZ	
3601059	Violino con strozza e arricavo	PZ	
3601055	Doppio	PZ	
3601054	Doppio con arricavo	PZ	
3601056	Triplo	PZ	
3601064	Triplo con strozza e arricavo	PZ	
3601065	Rinvio piano	PZ	
3601066	Rinvio su base	PZ	
3601068	Rinvio verticale	PZ	
3601071	Singolo a incasso	PZ	
3601072	Doppio a incasso	PZ	



**Bozzelli HS 8MM su Sfere**

Bozzelli HS su sfere per scotte fino a 8 mm.

Sfere e rinforzi in Acciaio Inox. Diametro puleggia 28 mm. Carico di rottura 600 Kg.



Cod.	Ref	UM	€
3608965	Singolo con perno	PZ	
3608951	Singolo	PZ	
3608953	Singolo girevole	PZ	
3608955	Singolo girevole con grillo	PZ	
3608952	Singolo con arricavo	PZ	
3608954	Singolo girevole con arricavo	PZ	
3608959	Singolo girevole con strozza e arricavo	PZ	
3608961	Doppio	PZ	
3608962	Doppio con arricavo	PZ	
3608963	Tripla	PZ	
3608964	Tripla con arricavo	PZ	
3608966	Tripla girevole con strozza e arricavo	PZ	

**Bozzelli HS 10MM su Sfere**

Bozzelli HS su sfere per scotte fino a 10 mm.

Sfere e rinforzi in Acciaio Inox.

Diametro puleggia 36 mm.

Carico di rottura 850 Kg.



Cod.	Ref	UM	€
3609053	Singolo girevole	PZ	
3609054	Singolo girevole con arricavo	PZ	
3609056	Violino girevole	PZ	
3609061	Singolo girevole con strozza e arricavo	PZ	
3609059	Violino girevole con strozza e arricavo	PZ	
3609062	Doppio	PZ	
3609063	Doppio con arricavo	PZ	
3609064	Tripla	PZ	

**Bozzelli HS 12MM su Sfere**

Bozzelli HS su sfere per scotte fino a 12 mm.

Sfere e rinforzi in Acciaio Inox.

Diametro puleggia 50 mm.

Carico di rottura 1000 Kg.



Cod.	Ref	UM	€
3609151	Singolo girevole	PZ	
3609153	Violino girevole	PZ	
3609154	Violino girevole con arricavo	PZ	
3609155	Singolo girevole con strozza e arricavo	PZ	
3609157	Violino girevole con strozza e arricavo	PZ	
3609159	Doppio	PZ	
3609160	Doppio con arricavo	PZ	
3609161	Tripla	PZ	



**Bozzelli HS 6MM**

Bozzelli HS su boccola per scotte fino a 6 mm.

Cassa in Acciaio Inox. Diametro puleggia 26 mm. Carico di rottura 700 Kg.



Cod.	Ref	UM	€
3600030	Singolo con perno	PZ	
3600031	Singolo	PZ	
3600032	Singolo girevole	PZ	
3600033	Singolo con arricavo	PZ	
3600041	Singolo con strozza e arricavo	PZ	
3600048	Singolo piano	PZ	
3600036	Doppio	PZ	
3600037	Doppio con arricavo	PZ	
3600042	Doppio con strozza e arricavo	PZ	
3600038	Tripla	PZ	
3600039	Tripla con arricavo	PZ	
3600043	Tripla con strozza e arricavo	PZ	

**Bozzelli HS 8MM**

Bozzelli HS su boccola per scotte fino a 8 mm.

Rinforzi in Acciaio Inox.

Diametro puleggia 28 mm.

Carico di rottura 600 Kg.



Cod.	Ref	UM	€
3608901	Singolo	PZ	
3608904	Singolo con arricavo	PZ	
3608911	Doppio	PZ	
3608972	Attacco girevole	PZ	

**Bozzelli HS 10MM**

Bozzelli HS su boccola per scotte fino a 10 mm.

Rinforzi in Acciaio Inox.

Diametro puleggia 36 mm.

Carico di rottura 850 Kg.



Cod.	Ref	UM	€
3609001	Singolo	PZ	
3609004	Singolo con arricavo	PZ	
3609006	Violino	PZ	
3609007	Violino con arricavo	PZ	
3609011	Singolo girevole con strozza e arricavo	PZ	
3609009	Violino girevole con strozza e arricavo	PZ	
3609012	Doppio	PZ	
3609013	Doppio con arricavo	PZ	
3609072	Attacco girevole	PZ	



**Bozzelli HS 12MM**

Bozzelli HS su boccola per scotte fino a 12 mm.

Rinforzi in Acciaio Inox.

Diametro puleggia 50 mm.

Carico di rottura 1000 Kg.



Cod.	Ref	UM	€
3609100	Singolo	PZ	
3609102	Singolo con arricavo	PZ	
3609103	Violino	PZ	
3609107	Violino girevole con strozza e arricavo	PZ	
3609109	Doppio	PZ	
3609110	Doppio con arricavo	PZ	
3609111	Triplo	PZ	
3609172	Attacco girevole	PZ	

**Bozzelli HS 14MM**

Bozzelli HS su boccola per scotte fino a 14 mm.

Rinforzi in Acciaio Inox.

Diametro puleggia 70 mm.

Carico di rottura 2500 Kg.



Cod.	Ref	UM	€
3601256	Singolo girevole	PZ	
3601257	Singolo con arricavo	PZ	
3601263	Violino girevole	PZ	
3601262	Violino girevole con strozza e arricavo	PZ	
3601260	Doppio	PZ	
3601261	Doppio con arricavo	PZ	



**Bozzelli Master Windrider 29MM su Sfere**

Bozzelli Master su sfere con puleggia da 29 mm. Cassa in materiale composito ultra leggero rinforzato con fibra e UV resistente con grillo girevole.

Sfere ad alto scorrimento in Delrin stabilizzato UV.



Cod.	Ref	L mm	Cima mm	WL Kg	BL Kg	UM	€
3612910	Singolo	66	<8	160	500	PZ	
3612911	Singolo con arricavo	78	<8	160	500	PZ	
3612920	Doppio	66	<8	160	500	PZ	
3612921	Doppio con arricavo	78	<8	160	500	PZ	
3612930	Triplo	66	<8	160	500	PZ	
3612931	Triplo con arricavo	78	<8	160	500	PZ	
3612950	Verticale	53	<8	160	500	PZ	

**Bozzelli Master Windrider 40MM su Sfere**

Bozzelli Master su sfere con puleggia da 40 mm. Cassa in materiale composito ultra leggero rinforzato con fibra e UV resistente con grillo girevole.

Sfere ad alto scorrimento in Delrin stabilizzato UV.

NB. Il carico di lavoro/rottura dei bozzelli con strozza scotte sono relativi allo strozza scotte.



Cod.	Ref	L mm	Cima mm	WL Kg	BL Kg	UM	€
3614010	Singolo	90	<10	230	800	PZ	
3614011	Singolo con arricavo	107	<10	230	800	PZ	
3614012	Singolo con arricavo e strozza	107	<8	80	200	PZ	
3614013	Violino	120	<10	230	800	PZ	
3614014	Violino con arricavo	135	<10	230	800	PZ	
3614015	Violino con arricavo e strozza	135	<8	80	200	PZ	
3614020	Doppio	90	<10	230	800	PZ	
3614021	Doppio con arricavo	107	<10	230	800	PZ	
3614030	Triplo	90	<10	230	800	PZ	
3614031	Triplo con arricavo	107	<10	230	800	PZ	
3614032	Triplo con arricavo e strozza	107	<8	80	200	PZ	
3614050	Verticale	67	<10	230	800	PZ	





**Bozzelli Master Windrider 57MM su Sfere**

Bozzelli Master su sfere con puleggia da 57 mm. Cassa in materiale composito ultra leggero rinforzato con fibra e UV resistente. Il grillo girevole può essere bloccato in due posizioni grazie alla leva di blocco. Sfere ad alto scorrimento in Delrin stabilizzato UV.

NB. Il carico di lavoro/rottura dei bozzelli con strozza scotte sono relativi allo strozza scotte.

Cod.	Ref	L mm	Cima mm	WL Kg	BL Kg	UM	€
3615710	Singolo	122	<10	370	1200	PZ	
3615711	Singolo con arricavo	144	<10	370	1200	PZ	
3615712	Singolo con arricavo e strozza	144	<10	100	250	PZ	
3615713	Violino	158	<10	370	1200	PZ	
3615714	Violino con arricavo	179	<10	370	1200	PZ	
3615715	Violino con arricavo e strozza	179	<10	100	250	PZ	
3615720	Doppio	122	<10	370	1200	PZ	
3615721	Doppio con arricavo	144	<10	370	1200	PZ	
3615730	Triplo	122	<10	370	1200	PZ	
3615731	Triplo con arricavo	144	<10	370	1200	PZ	
3615732	Triplo con arricavo e strozza	144	<10	100	250	PZ	

**Bozzelli Master Windrider 75MM su Sfere**

Bozzelli Master su sfere con puleggia da 75 mm. Cassa in materiale composito ultra leggero rinforzato con fibra e UV resistente. Il grillo girevole può essere bloccato in due posizioni grazie alla leva di blocco. Sfere ad alto scorrimento in Delrin stabilizzato UV.

NB. Il carico di lavoro/rottura dei bozzelli con strozza scotte sono relativi allo strozza scotte.

Cod.	Ref	L mm	Cima mm	WL kg	BL Kg	UM	€
3617510	Singolo	141	<14	560	1700	PZ	
3617511	Singolo con arricavo	168	<14	560	1700	PZ	
3617512	Singolo con arricavo e strozza	168	<12	100	250	PZ	
3617520	Doppio	148	<14	560	1700	PZ	
3617521	Doppio con arricavo	174	<14	560	1700	PZ	
3617530	Triplo	148	<14	560	1700	PZ	
3617531	Triplo con arricavo	174	<14	560	1700	PZ	
3617532	Triplo con arricavo e strozza	174	<12	100	250	PZ	



**Bozzelli Master Plain Bearing 50MM**

Bozzelli Master su boccola con grande capacità di carico e puleggia da 50 mm. Cassa in materiale composito ultra leggero rinforzato con fibra e UV resistente. Il grillo girevole può essere bloccato in due posizioni grazie alla leva di blocco.

NB. Il carico di lavoro/rottura dei bozzelli con strozza scotte sono relativi allo strozza scotte.

Cod.	Ref	L mm	Cima mm	WL Kg	BL Kg	UM	€
<b>3610510</b>	Singolo	101	<10	522	1050	PZ	
<b>3610511</b>	Singolo con arricavo	120	<10	522	1050	PZ	
<b>3610512</b>	Violino	130	<10	522	1050	PZ	
<b>3610513</b>	Violino con arricavo	147	<10	522	1050	PZ	
<b>3610515</b>	Singolo con arricavo e strozza	120	<10	100	250	PZ	
<b>3610516</b>	Violino con arricavo e strozza	147	<10	100	250	PZ	
<b>3610520</b>	Doppio	101	<10	522	1050	PZ	
<b>3610521</b>	Doppio con arricavo	120	<10	522	1050	PZ	
<b>3610530</b>	Triplo	101	<10	522	1050	PZ	
<b>3610532</b>	Triplo con arricavo e strozza	120	<8	100	250	PZ	
<b>3610505</b>	Singolo piede albero	90	<10	522	1050	PZ	

**Bozzelli Master Plain Bearing 60MM**

Bozzelli Master su boccola con grande capacità di carico e puleggia da 60 mm. Cassa in materiale composito ultra leggero rinforzato con fibra e UV resistente. Il grillo girevole può essere bloccato in due posizioni grazie alla leva di blocco.

NB. Il carico di lavoro/rottura dei bozzelli con strozza scotte sono relativi allo strozza scotte.

Cod.	Ref	L mm	Cima mm	WL Kg	BL Kg	UM	€
<b>3610610</b>	Singolo	114	<12	600	1500	PZ	
<b>3610611</b>	Singolo con arricavo	138	<12	600	1500	PZ	
<b>3610612</b>	Violino	154	<12	600	1500	PZ	
<b>3610613</b>	Violino con arricavo	178	<12	600	1500	PZ	
<b>3610614</b>	Violino con arricavo e strozza	178	<12	100	250	PZ	
<b>3610605</b>	Singolo piede albero	107	<12	600	1500	PZ	



**Bozzelli Master Plain Bearing 72MM**

Bozzelli Master su boccola con grande capacità di carico e puleggia da 72 mm. Cassa in materiale composito ultra leggero rinforzato con fibra e UV resistente. Il grillo girevole può essere bloccato in due posizioni grazie alla leva di blocco.

NB. Il carico di lavoro/rottura dei bozzelli con strozza scotte sono relativi allo strozza scotte.

Cod.	Ref	L mm	Cima mm	WL Kg	BL Kg	UM	€
<b>3610710</b>	Singolo	140	<12	1000	2000	PZ	
<b>3610711</b>	Singolo con arricavo	168	<12	1000	2000	PZ	
<b>3610712</b>	Violino	190	<12	1000	2000	PZ	
<b>3610713</b>	Violino con arricavo	213	<12	1000	2000	PZ	
<b>3610714</b>	Violino con arricavo e strozza	213	<12	100	250	PZ	
<b>3610720</b>	Doppio	143	<12	1000	2000	PZ	
<b>3610721</b>	Doppio con arricavo	170	<12	1000	2000	PZ	
<b>3610705</b>	Singolo piede albero	138	<12	1000	2000	PZ	

**Bozzelli Master Plain Bearing 90MM**

Bozzelli Master su boccola con grande capacità di carico e puleggia da 90 mm. Cassa in materiale composito ultra leggero rinforzato con fibra e UV resistente. Il grillo girevole può essere bloccato in due posizioni grazie alla leva di blocco.

Cod.	Ref	L mm	Cima mm	WL Kg	BL Kg	UM	€
<b>3610910</b>	Singolo	188	<14	1800	3000	PZ	
<b>3610911</b>	Singolo con arricavo	225	<14	1800	3000	PZ	
<b>3610912</b>	Violino	250	<14	1800	3000	PZ	
<b>3610913</b>	Violino con arricavo	280	<14	1800	3000	PZ	

**Bozzelli Master Hercules in Alluminio su Sfere**

Bozzelli Master su sfere con puleggia e cassa in Alluminio anodizzato nero. Il grillo girevole può essere bloccato in due posizioni grazie alla leva di blocco.

Sfere ad alto scorrimento in Delrin stabilizzato UV.

Cod.	Ref	ø mm	L mm	Cima mm	WL Kg	BL Kg	UM	€
<b>3611510</b>	Singolo	57	140	<16	1100	2000	PZ	
<b>3611710</b>	Singolo	75	165	<19	1600	3200	PZ	
<b>3611511</b>	Singolo con arricavo	57	170	<16	1100	2000	PZ	
<b>3611711</b>	Singolo con arricavo	75	197	<19	1600	3200	PZ	
<b>3611512</b>	Singolo piede albero	57	95	<16	1100	2000	PZ	
<b>3611712</b>	Singolo piede albero	75	118	<19	1600	3200	PZ	



**Bozzello Singolo**

Bozzello molto robusto senza perni e viti con telaio in Alluminio Ossidato nero e teflonato in un unico pezzo. Con pulegge in resina su doppio cuscinetto a sfere che non necessita di lubrificazione. Compreso di testa girevole e grillo in Acciaio Inox ad alta resistenza. L'uso dei migliori materiali garantisce leggerezza e carichi di lavoro elevati.

**antal**

Cod.	Ref	Puleggia mm	Cima mm	Carico di lavoro Kg	UM	€
3600901	Bozzello singolo	50	<10	600	PZ	
3600911	Bozzello singolo + cam	50	<10	600	PZ	
3600931	Bozzello singolo	60	<12	800	PZ	
3600951	Bozzello singolo + cam	60	<12	800	PZ	
3600961	Bozzello singolo	70	<12	1300	PZ	
3600981	Bozzello singolo + cam	70	<12	1300	PZ	

**Bozzello Singolo con Arricavo**

Bozzello molto robusto senza perni e viti con telaio in Alluminio Ossidato nero e teflonato in un unico pezzo. Con pulegge in resina su doppio cuscinetto a sfere che non necessita di lubrificazione. Compreso di testa girevole e grillo in Acciaio Inox ad alta resistenza. L'uso dei migliori materiali garantisce leggerezza e carichi di lavoro elevati.

**antal**

Cod.	Ref	Puleggia mm	Cima mm	Carico di lavoro Kg	UM	€
3600902	Bozzello singolo con arricavo	50	<10	600	PZ	
3600912	Bozzello singolo con arricavo + cam	50	<10	600	PZ	
3600932	Bozzello singolo con arricavo	60	<12	800	PZ	
3600952	Bozzello singolo con arricavo + cam	60	<12	800	PZ	
3600962	Bozzello singolo con arricavo	70	<12	1300	PZ	
3600982	Bozzello singolo con arricavo + cam	70	<12	1300	PZ	

**Bozzello Violino**

Bozzello molto robusto senza perni e viti con telaio in Alluminio Ossidato nero e teflonato in un unico pezzo. Con pulegge in resina su doppio cuscinetto a sfere che non necessita di lubrificazione. Compreso di testa girevole e grillo in Acciaio Inox ad alta resistenza. L'uso dei migliori materiali garantisce leggerezza e carichi di lavoro elevati.

**antal**

Cod.	Ref	Puleggia mm	Cima mm	Carico di lavoro Kg	UM	€
3600903	Bozzello a violino	50	<10	600	PZ	
3600913	Bozzello a violino + cam	50	<10	600	PZ	
3600933	Bozzello a violino	60	<12	800	PZ	
3600953	Bozzello a violino + cam	60	<12	800	PZ	
3600963	Bozzello a violino	70	<12	1300	PZ	
3600983	Bozzello a violino + cam	70	<12	1300	PZ	

**Bozzello Violino con Arricavo**

Bozzello molto robusto senza perni e viti con telaio in Alluminio Ossidato nero e teflonato in un unico pezzo. Con pulegge in resina su doppio cuscinetto a sfere che non necessita di lubrificazione. Compreso di testa girevole e grillo in Acciaio Inox ad alta resistenza. L'uso dei migliori materiali garantisce leggerezza e carichi di lavoro elevati.

**antal**

Cod.	Ref	Puleggia mm	Cima mm	Carico di lavoro Kg	UM	€
3600904	Bozzello a violino con arricavo	50	<10	600	PZ	
3600914	Bozzello a violino con arricavo + cam	50	<10	600	PZ	
3600934	Bozzello a violino con arricavo	60	<12	800	PZ	
3600954	Bozzello a violino con arricavo + cam	60	<12	800	PZ	
3600964	Bozzello a violino con arricavo	70	<12	1300	PZ	
3600984	Bozzello a violino con arricavo + cam	70	<12	1300	PZ	



**Bozzello Doppio**

Bozzello molto robusto senza perni e viti con telaio in Alluminio Ossidato nero e teflonato in un unico pezzo. Con pulegge in resina su doppio cuscinetto a sfere che non necessita di lubrificazione. Compreso di testa girevole e grillo in Acciaio Inox ad alta resistenza. L'uso dei migliori materiali garantisce leggerezza e carichi di lavoro elevati.

**antal**

Cod.	Ref	Puleggia mm	Cima mm	Carico di lavoro Kg	UM	€
3600905	Bozzello doppio	50	<10	800	PZ	
3600915	Bozzello doppio + cam	50	<10	800	PZ	
3600935	Bozzello doppio	60	<12	1300	PZ	
3600955	Bozzello doppio + cam	60	<12	1300	PZ	
3600965	Bozzello doppio	70	<12	2200	PZ	
3600985	Bozzello doppio + cam	70	<12	2200	PZ	

**Bozzello Doppio con Arricavo**

Bozzello molto robusto senza perni e viti con telaio in Alluminio Ossidato nero e teflonato in un unico pezzo. Con pulegge in resina su doppio cuscinetto a sfere che non necessita di lubrificazione. Compreso di testa girevole e grillo in Acciaio Inox ad alta resistenza. L'uso dei migliori materiali garantisce leggerezza e carichi di lavoro elevati.

**antal**

Cod.	Ref	Puleggia mm	Cima mm	Carico di lavoro Kg	UM	€
3600906	Bozzello doppio con arricavo	50	<10	800	PZ	
3600916	Bozzello doppio con arricavo + cam	50	<10	800	PZ	
3600936	Bozzello doppio con arricavo	60	<12	1300	PZ	
3600956	Bozzello doppio con arricavo + cam	60	<12	1300	PZ	
3600966	Bozzello doppio con arricavo	70	<12	2200	PZ	
3600986	Bozzello doppio con arricavo + cam	70	<12	2200	PZ	

**Bozzello Triplo**

Bozzello molto robusto senza perni e viti con telaio in Alluminio Ossidato nero e teflonato in un unico pezzo. Con pulegge in resina su doppio cuscinetto a sfere che non necessita di lubrificazione. Compreso di testa girevole e grillo in Acciaio Inox ad alta resistenza. L'uso dei migliori materiali garantisce leggerezza e carichi di lavoro elevati.

**antal**

Cod.	Ref	Puleggia mm	Cima mm	Carico di lavoro Kg	UM	€
3600907	Bozzello triplo	50	<10	800	PZ	
3600917	Bozzello triplo + cam	50	<10	800	PZ	
3600937	Bozzello triplo	60	<12	1300	PZ	
3600957	Bozzello triplo + cam	60	<12	1300	PZ	
3600967	Bozzello triplo	70	<12	2200	PZ	
3600987	Bozzello triplo + cam	70	<12	2200	PZ	

**Bozzello Triplo con Arricavo**

Bozzello molto robusto senza perni e viti con telaio in Alluminio Ossidato nero e teflonato in un unico pezzo. Con pulegge in resina su doppio cuscinetto a sfere che non necessita di lubrificazione. Compreso di testa girevole e grillo in Acciaio Inox ad alta resistenza. L'uso dei migliori materiali garantisce leggerezza e carichi di lavoro elevati.

**antal**

Cod.	Ref	Puleggia mm	Cima mm	Carico di lavoro Kg	UM	€
3600908	Bozzello triplo con arricavo	50	<10	800	PZ	
3600918	Bozzello triplo con arricavo + cam	50	<10	800	PZ	
3600938	Bozzello triplo con arricavo	60	<12	1300	PZ	
3600958	Bozzello triplo con arricavo + cam	60	<12	1300	PZ	
3600968	Bozzello triplo con arricavo	70	<12	2200	PZ	
3600988	Bozzello triplo con arricavo + cam	70	<12	2200	PZ	



**Bozzello Web**

Bozzello molto robusto senza perni e viti con telaio in Alluminio Ossidato nero e teflonato in un unico pezzo. Con pulegge in resina su doppio cuscinetto a sfere che non necessita di lubrificazione. L'uso dei migliori materiali garantisce leggerezza e carichi di lavoro elevati.

**antal**

Cod.	Ref	Puleggia mm	Cima mm	Carico di lavoro Kg	UM	€
<b>3600909</b>	Bozzello Web	50	<10	600	PZ	
<b>3600939</b>	Bozzello Web	60	<12	800	PZ	
<b>3600969</b>	Bozzello Web	70	<12	1300	PZ	

**Bozzello su Golfare a U**

Bozzello molto robusto senza perni e viti con telaio in Alluminio Ossidato nero e teflonato in un unico pezzo. Con pulegge in resina su doppio cuscinetto a sfere che non necessita di lubrificazione. Compreso di testa girevole e golfare in Acciaio Inox ad alta resistenza. L'uso dei migliori materiali garantisce leggerezza e carichi di lavoro elevati.

**antal**

Cod.	Ref	Puleggia mm	Cima mm	Carico di lavoro Kg	UM	€
<b>3600923</b>	Bozzello su golfare	50	<10	500	PZ	
<b>3600943</b>	Bozzello su golfare	60	<12	800	PZ	
<b>3600973</b>	Bozzello su golfare	70	<12	1300	PZ	

**Rinvio Singolo e Doppio**

Bozzello molto robusto senza perni e viti con telaio in Alluminio Ossidato nero e teflonato in un unico pezzo. Con pulegge in resina su doppio cuscinetto a sfere che non necessita di lubrificazione. Compreso di viti in Acciaio Inox ad alta resistenza. L'uso dei migliori materiali garantisce leggerezza e carichi di lavoro elevati.

**antal**

Cod.	Ref	Puleggia mm	Cima mm	Carico di lavoro Kg	UM	€
<b>3600921</b>	Rinvio singolo	50	<10	600	PZ	
<b>3600922</b>	Rinvio doppio	50	<10	600	PZ	
<b>3600941</b>	Rinvio singolo	60	<12	800	PZ	
<b>3600942</b>	Rinvio doppio	60	<12	800	PZ	
<b>3600971</b>	Rinvio singolo	70	<12	1300	PZ	
<b>3600972</b>	Rinvio doppio	70	<12	1300	PZ	

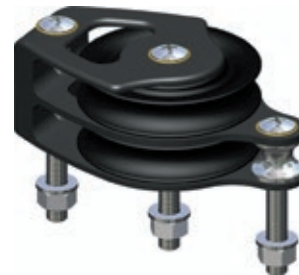
**- BOZZELLI APRIBILI ANTAL -****Bozzelli Apribili Mini D=32 mm**

Bozzello Apribile Mini D=32 mm completamente in resina ad alta resistenza, con doppio cuscinetto a sfere. Si può fissare con una cima o con un grillo. Lo Snap Ring è un anello tessile con sistema di bloccaggio veloce e sicuro che si usa per evitare aperture accidentali.

**antal**

Cod.	Ref	Testa	Puleggia mm	Cima mm	Carico di lavoro Kg	UM	€
<b>3601140</b>	Bozzello	Fissa	32	<8	250	PZ	
<b>3601143</b>	Snap Ring					PZ	

**Bozzelli Apribili D=40 & 60 mm**

La guancia ruota attorno all'asse della puleggia permettendo l'apertura del bozzello; una sfera di sicurezza garantisce la chiusura e una vite di regolazione può bloccare il bozzello chiuso. Da connettere con una cima tessile. Fornito di arricavo per un elastico di sospensione. Materiali: puleggia con cuscinetto principale in fibra e doppio cuscinetto laterale a sfere. Guance in Alluminio ossidato nero e teflonato e protezioni laterali in gomma (gialla sulla guancia rotante).

**antal**

Cod.	Bozzello	Testa	Puleggia mm	Cima mm	Carico di lavoro Kg	UM	€
<b>3601145</b>	D40	Fissa	40	<12	700	PZ	
<b>3601146</b>	D60	Fissa	60	<14	1300	PZ	



**Bozzelli Rinvio Verticale**

Bozzelli rinvio con puleggia su sfere. Rinforzi Inox.



Cod.	ø Puleggia mm	ø Scotta mm	UM	€
3602423	28	8	PZ	
3602424	35	10	PZ	



**Rinvio con Morsetto Clamp**

Bozzello di rinvio con morsetto da ø 25 mm.



Cod.	ø Puleggia mm	ø Scotta mm	UM	€
3602428	28	8	PZ	
3602430	35	10	PZ	



**Guida Scotta Clamp**

Guida scotta Inox con morsetto da ø 25 mm.



Cod.	UM	€
3602431	PZ	



**Rinvio Single Plate**

Rinvio con puleggia ø 20 mm. Scotta <6 mm.



Cod.	UM	€
3600008	PZ	



**Rinvio da Ponte HS VB**

Rinvio da ponte HS con puleggia su sfere. Distanza asse puleggia - base: 25 mm. Gabbia in Acciaio Inox. Scotta <8 mm / CR = 300 Kg.



Cod.	Ref	Accessori	UM	€
3722418	Rinvio HS VB		PZ	
3722419		Basetta per montaggio verticale	PZ	



**Rinvio HS 8B**

Rinvio da ponte HS. Puleggia ø 28 mm su sfere. Gabbia in Acciaio Inox. Scotta <8 mm / CR = 600 Kg.



Cod.	UM	€
3722408	PZ	



**Rinvio HS Deck 12**

Rinvio da ponte HS per scotta <12 mm.



Cod.	L mm	Cr Kg	UM	€
3722912	96	1000	PZ	



**Passascotte**

Passa scotte a ponte in Nylon.



Cod.	Scotta mm	UM	€
3703603	<9	PZ	
3703602	<13	PZ	
3703601	<15	PZ	



**Rinvio HS Deck Series Midi**

Rinvio da ponte HS con 1 - 2 - 3 pulegge.

Cod.	Pulegge	L mm	Cima ø mm	Cr Kg	UM	€
3722951	1	69	<12	800	PZ	
3722952	2	124	<12	800	PZ	
3722953	3	178	<12	800	PZ	

**Rulliera per V-CAM 814 Antal**

Rulliera che permette di deviare la manovra in uscita verso i winch. Carter e pulegge in Alluminio ossidato nero con cuscinetti a sfere. Carico di lavoro massimo 400 Kg.

Cod.	Pulegge	L mm	Cima ø mm	Carico di lavoro Kg	UM	€
3723013	3	110	<14	400	PZ	
3723014	4	139	<14	400	PZ	
3723015	5	168	<14	400	PZ	
3723016	6	197	<14	400	PZ	

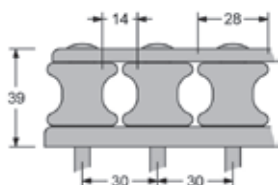
**antal****Antal Organizers D=40 - D=50**

Carenatura in Alluminio anodizzato nero, pulegge in resina ad alta resistenza su cuscinetti a sfere. Tutti i modelli sono forniti con viti, rondelle e dadi in Acciaio Inox AISI 316.

Cod.	Pulegge	D mm	P mm	L mm	Cima ø mm	Carico lavoro Kg	UM	€
3723512	2	40	44	111	<14	600	PZ	
3723513	3	40	44	155	<14	600	PZ	
3723514	4	40	44	199	<14	600	PZ	
3723515	5	40	44	243	<14	600	PZ	
3723516	6	40	44	287	<14	600	PZ	
3723502	2	50	52	133	<16	800	PZ	
3723503	3	50	52	185	<16	800	PZ	
3723504	4	50	52	237	<16	800	PZ	
3723505	5	50	52	289	<16	800	PZ	
3723506	6	50	52	341	<16	800	PZ	

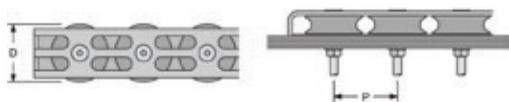
**antal****Master Deck Organizers**

Deck organizers Master con pulegge da 57 mm e cassa in Alluminio anodizzato nero. Cuscinetti su sfere ad alto scorrimento in Delrin stabilizzato UV. Interasse pulegge 78,5 mm.

Cod.	Pulegge	L mm	Cima ø mm	Carico lavoro Kg	UM	€
3723212	2	169	<16	2000	PZ	
3723213	3	248	<16	2000	PZ	
3723214	4	326	<16	2000	PZ	
3723215	5	405	<16	2000	PZ	

**MASTER**



**Anelli Antal**

Anelli Antal molto resistenti e leggeri in Alluminio Anodizzato nero ideali per tutte le soluzioni da ponte.

Cod.	ø mm	Foro ø mm	Per cima ø mm	Carico lavoro Kg	UM	€
3723110	18	7	5	400	PZ	
3723111	25	10	7	800	PZ	
3723112	35	14	10	1600	PZ	
3723113	50	20	14	3200	PZ	
3723114	70	28	20	6400	PZ	
3723115	99	38	28	10000	PZ	

**Anelli Solid Ring Antal**

Anelli Solid Ring Antal molto resistenti e leggeri in Alluminio Anodizzato nero lucidato a specchio a minimo attrito. Ideali per le mani dei terzaroli, per la regolazione 3D della scotta genoa e per tutte le soluzioni da ponte.

Cod.	ø mm	Foro ø mm	Carico lavoro Kg	UM	€
3723120	56	30	1800	PZ	
3723121	64	34	2800	PZ	
3723122	76	40	4400	PZ	
3723123	94	50	6500	PZ	

**- STROZZASCOTTE -****Strozzascotte HS Cleat**

Strozzascotte HS Midi e Mini Cleat in Camlan.

Cod.	Scotta mm	UM	€
3712507	3<6	PZ	
3712505	8<13	PZ	

**Guida Singola HS per Strozzascotte**

Guida singola per strozzascotte HS Mini e Midi.

Cod.	Ref	UM	€
3713520	Mini	PZ	
3713530	Midi	PZ	

**Guida Doppia HS per Strozzascotte**

Guida doppia per strozzascotte HS Mini e Midi.

Cod.	Ref	UM	€
3713522	Mini	PZ	
3713532	Midi	PZ	

**Strozzascotte Master**

Strozzascotte Master in Alluminio anodizzato nero resistente alla corrosione e ai raggi UV. Camme con molla in tensione costante su sfere ad alto scorrimento in Delrin.

Nota: Il carico di rottura è due volte il carico di lavoro.

Cod.	Scotta mm	H mm	Interasse viti mm	Carico di lavoro Kg	UM	€
3714527	3<6	22	27 (M4)	100	PZ	
3714538	3<12	27	38 (M5)	150	PZ	
3714552	6<16	32	52,2 (M6)	250	PZ	

**MASTER****Guida Master per Strozzascotte**

Guida a ponticello per strozzascotte Master.

Cod.	Ref interasse	UM	€
3714507	Small (27 mm)	PZ	
3714508	Medium (38 mm)	PZ	

**MASTER**

**Stopper Easylock I**

Stopper Easylock I permette di cazzare e lasciare la scotta sotto carico.

Guance in Alluminio Anodizzato.

L 108 mm. Carico di lavoro 300 Kg.

**easy**

Cod.	Stopper	Scotte ø mm	Ricambi	UM	€
<b>3707810</b>	Singolo	6<10		PZ	
<b>3707820</b>	Doppio	6<10		PZ	
<b>3707830</b>	Triplo	6<10		PZ	
<b>3707831</b>			Leva ricambio	PZ	

**Stopper Easylock Mini**

Stopper Easylock Mini permette di cazzare e lasciare la scotta sotto carico.

Guance in Alluminio Anodizzato.

L 115 mm. Carico di lavoro 450 Kg.

**easy**

Cod.	Stopper	Scotte ø mm	Ricambi	UM	€
<b>3708010</b>	Singolo	6<10		PZ	
<b>3708020</b>	Doppio	6<10		PZ	
<b>3708030</b>	Triplo	6<10		PZ	
<b>3708031</b>			Leva ricambio	PZ	

**Stopper Easylock Midi**

Stopper Easylock Midi permette di cazzare e lasciare la scotta sotto carico.

Guance in Alluminio Anodizzato.

L 140 mm. Carico di lavoro 700 Kg.

**easy**

Cod.	Stopper	Scotte ø mm	Ricambi	UM	€
<b>3709210</b>	Singolo	6<12		PZ	
<b>3709220</b>	Doppio	6<12		PZ	
<b>3709230</b>	Triplo	6<12		PZ	
<b>3709231</b>			Leva ricambio	PZ	

**Stopper Master XTC**

Stopper Master XTC in composito nero resistente raggi UV con parti meccaniche in Acciaio Inox e Alluminio anodizzato. Progettato per cazzare e lasciare con facilità la cima sotto carichi elevati.

**MASTER**

Cod.	Stopper	Cima ø mm	Carico di lavoro Kg	Carico massimo Kg	UM	€
<b>3707501</b>	Singolo	8<12	300	600	PZ	
<b>3707502</b>	Doppio	8<12	300	600	PZ	
<b>3707503</b>	Triplo	8<12	300	600	PZ	



**Stopper Antal Cam 611**

Stopper Antal Cam 611 automatico che permette il recupero e bloccaggio della manovra nella nuova posizione a stopper chiuso, oppure di cazzare e lasciare la scotta sotto carico.

Cod.	Ref	Cima ø mm	UM	€
3703010	Singolo	6<11	PZ	
3703020	Doppio	6<11	PZ	
3703030	Triplo	6<11	PZ	

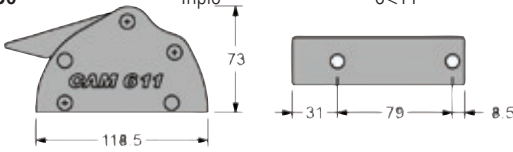
**antal****Stopper Antal V-CAM 814**

Stopper Antal V-CAM 814, aumenta la lunghezza di bloccaggio senza deformare il cavo. Ideale per cavi rigidi come Kevlar, Spectra, Vectran etc. Eccellente su poliestere. Struttura in resina anti-UV con rinforzi in Acciaio, base in Alluminio, camma a V e guide di allineamento in Acciaio. Completamente smontabile per una facile manutenzione e riparazione. Il recupero è possibile a stopper chiuso, la manovra si blocca automaticamente nella nuova posizione.

Cod.	Ref	Cima ø mm	UM	€
3707151	Singolo	8<10	PZ	
3707152	Doppio	8<10	PZ	
3707153	Triplo	8<10	PZ	
3707161	Singolo	10<12	PZ	
3707162	Doppio	10<12	PZ	
3707163	Triplo	10<12	PZ	
3707171	Singolo	12<14	PZ	
3707172	Doppio	12<14	PZ	
3707173	Triplo	12<14	PZ	

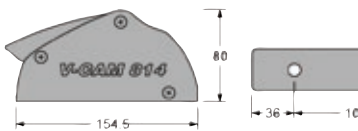
**antal****Stopper Antal V-GRIP**

Stopper Antal V-GRIP che aumenta la lunghezza di bloccaggio senza deformare il cavo. Ideale per cavi rigidi come Kevlar, Spectra, Vectran etc. Eccellente su Poliestere. Struttura interna in Acciaio. Possibile il rilascio in tensione senza verricello e il recupero senza apertura dello stopper che blocca la manovra nella nuova posizione. Solo 6,5 cm di altezza.

Cod.	Ref	Cima ø mm	UM	€
3707111	Singolo	8<12	PZ	
3707121	Doppio	8<12	PZ	
3707131	Triplo	8<12	PZ	
3707112	Singolo	10<14	PZ	
3707122	Doppio	10<14	PZ	
3707132	Triplo	10<14	PZ	
3707113	Singolo	12<16	PZ	

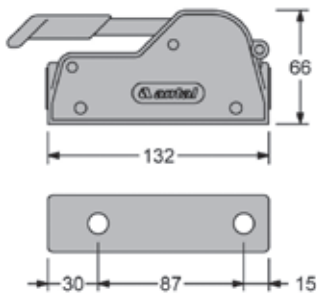
**antal****Etichette Segna Stopper**

Set etichette adesive segna stopper per una facile identificazione delle manovre. Composto da 20 etichette per ciascun colore: Nero, Rosso, Verde e Bianco.

Cod.	Lingua	UM	€
3703000	Inglese	PZ	
3703001	Francese	PZ	
3703002	Italiano	PZ	

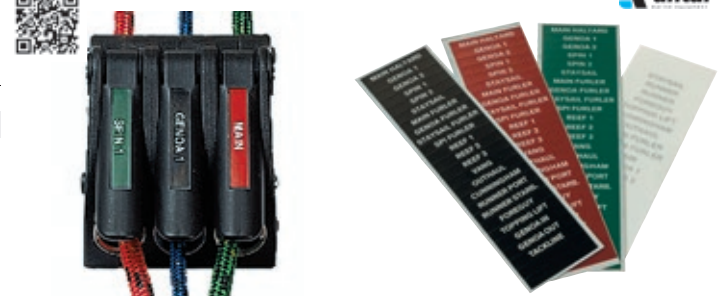
**antal**

**Winch Velocita' Diretta**

Winch Antal a una velocità diretta. La rotazione oraria della manovella innesta l'unica velocità: la diretta. In senso antiorario la manovella gira libera.

**antal**

Cod.	Ref	Power	Peso Kg	ø mm	ø1 mm	H mm	UM	€
<b>3730110</b>	W6	6.7	0.40	94	60	87	PZ	
<b>3730111</b>	W7	6.7	0.70	97	60	95	PZ	
<b>3730113</b>	W8	7.3	1.50	110	70	105	PZ	

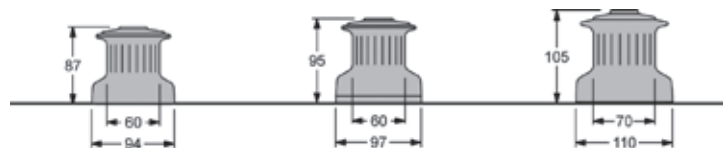
**Winch Self Tailing XT Velocita' Ridotta**

Winch Self Tailing XT compatti a velocità ridotta lenta e potente. Nell'altro verso la manovella gira libera. Per scotte da 6<>10 mm.

**antal**

Cod.	Ref	Power	Peso Kg	ø mm	ø1 mm	H mm	UM	€
<b>3740211</b>	XT16	14	2.40	112	71	119	PZ	
<b>3740212</b>	XT30	28	2.70	128	73	135	PZ	

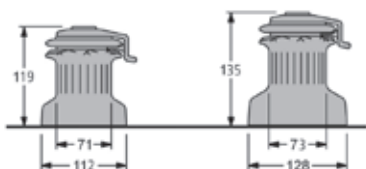
**Winch Self-Tailing XT Velocita' Diretta e Ridotta**

Winch Self-Tailing XT a velocità diretta e ridotta. La possibilità di un recupero veloce assieme ai pesi e alle dimensioni molto contenuti li rende ottimali per la regata. Per scotte da 6<>10 mm.

**antal**

Cod.	Ref	Power	Peso Kg	ø mm	ø1 mm	H mm	UM	€
<b>3740221</b>	XT16.2	7/14	2.60	112	71	119	PZ	
<b>3740222</b>	XT30.2	7/28	2.90	128	73	135	PZ	

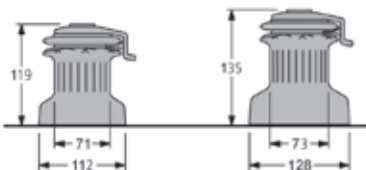
**Winch Self Tailing XT Due Velocita' Ridotte**

Winch Self Tailing XT a due velocità ridotte. Con il primo rapporto, pur realizzando notevoli potenze, si ha un recupero veloce; all'aumentare dello sforzo, cambiando il verso di rotazione della manovella, si inserisce automaticamente la seconda velocità che realizza la massima potenza. Per scotte da 6<>14 mm.

**antal**

Cod.	Ref	Power	Peso Kg	ø mm	ø1 mm	H mm	UM	€
<b>3740225</b>	XT40	13/40	4.40	153	80	157	PZ	
<b>3740226</b>	XT44	20/43	6.20	173	93	185	PZ	
<b>3740227</b>	XT48	19/47	6.90	182	93	197	PZ	

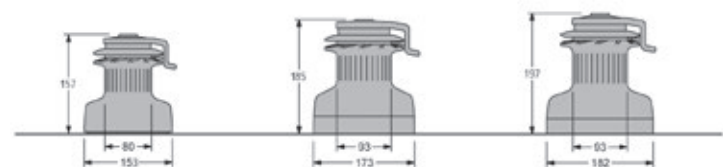

**Manovelle Antal Single-Grip**

Leggerissime manovelle standard single grip in Alluminio nero da 200 e 250 mm (8/10"). Il profilo è forgiato in Alluminio a caldo con fori di alleggerimento è leggerissimo e resiste alle torsioni più violente. L'impugnatura, rivestita in gomma per una presa più salda, scorre su 2 cuscinetti a sfere che ne aumentano l'efficienza. Tutti i modelli hanno il fermo che blocca automaticamente la manovella sul winch.



Cod.	Impugnatura	L mm	Peso g	UM	€
<b>3751201</b>	Single-Grip	200	400	PZ	
<b>3751251</b>	Single-Grip	250	460	PZ	

**antal****Manovelle Antal Power-Grip**

Leggerissime manovelle in Alluminio nero da 250 mm (10"). Disponibili con impugnatura doppia e la nuova ball-grip. Il profilo è forgiato in Alluminio a caldo con fori di alleggerimento; è leggerissimo e resiste alle torsioni più violente. L'impugnatura, rivestita in gomma per una presa più salda, scorre su 2 cuscinetti a sfere che ne aumentano l'efficienza. Tutti i modelli hanno il fermo che blocca automaticamente la manovella sul winch.



Cod.	Impugnatura	L mm	Peso g	UM	€
<b>3751252</b>	Ball-Grip	250	490	PZ	
<b>3751253</b>	Doppia	250	540	PZ	

**antal****Manovelle Antal Speedylock**

Leggerissima e resistente manovella in Alluminio forgiato a caldo, con fori di alleggerimento e impugnatura su doppio cuscinetto a sfere rivestita in gomma per una presa più salda. Dotata di pratico meccanismo di fermo Speedylock che garantisce un rapidissimo inserimento e uso della manovella.



Cod.	Impugnatura	L mm	Peso g	UM	€
<b>3751200</b>	Single-Grip	250	430	PZ	
<b>3751202</b>	Ball-Grip	250	530	PZ	

**antal****Manovelle Antal Chrome**

Leggere manovelle in Bronzo Cromato da 250 mm (10") con due diverse impugnature: single e ball grip. Il profilo è forgiato in Bronzo a caldo, è leggero e resiste alle torsioni più violente. L'impugnatura, rivestita in gomma per una presa più salda, scorre su 2 cuscinetti a sfere che ne aumentano l'efficienza. Tutti i modelli hanno il fermo che blocca automaticamente la manovella sul winch.



Cod.	Impugnatura	L mm	Peso g	UM	€
<b>3751260</b>	Single-Grip	250	870	PZ	
<b>3751261</b>	Ball-Grip	250	970	PZ	

**antal****Manovella Base Single Grip**

Manovella ideale per piccole e medie imbarcazioni. Struttura robusta e leggera con blocco. Galleggia.



Cod.	L mm	UM	€
<b>3750224</b>	200	PZ	
<b>3750225</b>	250	PZ	

**MTM**

**Carrello e Rotaia Genoa 26x4**

Carrello in Alluminio ossidato Nero con fermo d'arresto in Acciaio Inox AISI 316 e pattini di scorrimento in Nylon. Supporto puleggia in Acciaio Inox AISI 316 orientabile ( $\pm 50^\circ$ ). Puleggia in resina su cuscinetti a sfere laterali (self-captive) a sezione allargata per il passaggio della doppia scotta. Carico di lavoro (SWL) 800 Kg.  
Rotaia a T passo foratura 50 mm.  
Profilo in Alluminio ad alta resistenza.  
Fissaggio con viti da 5 mm.

**antal**

Cod.	Ref	Rotaia	UM	€
<b>3722026</b>	Carrello		PZ	
<b>3722025</b>		26x4 - 1.0 m	PZ	
<b>3722029</b>		26x4 - 2.0 m	PZ	
<b>3722027</b>		Terminale rotaia	PZ	

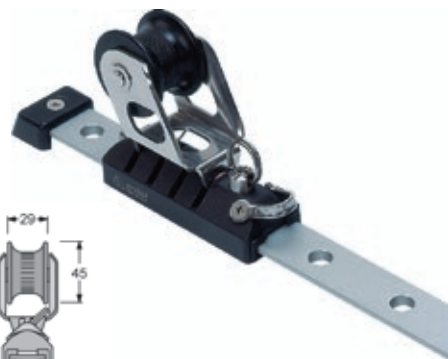
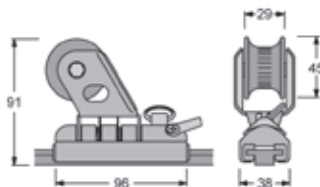
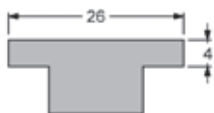
**Carrello e Rotaia Genoa 32x6**

Carrello in Alluminio ossidato Nero su pattini in Nylon a basso attrito. Supporto puleggia in Acciaio AISI 316 orientabile ( $\pm 50^\circ$ ). Puleggia in resina con doppio cuscinetto laterale a sfere (self-captive) a sezione allargata per il passaggio della doppia scotta. Fermo d'arresto in Acciaio AISI 316 con posizione di disinserimento. Arricavo frontale.  
Carico di lavoro (SWL) 2800 Kg.  
Rotaia a T passo foratura 100 mm.  
Profilo in Alluminio ad alta resistenza anodizzato.  
Fissaggio con viti da 6 mm.

**antal**

Cod.	Ref	Rotaia	UM	€
<b>3722032</b>	Carrello		PZ	
<b>3722035</b>		32x6 - 2.0 m	PZ	
<b>3722036</b>		32x6 - 3.0 m	PZ	
<b>3722033</b>		Terminale rotaia	PZ	

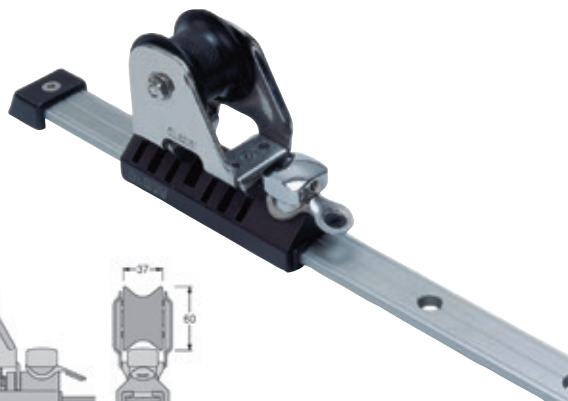
**Carrello e Rotaia Genoa 40x8**

Carrello in Alluminio ossidato Nero su pattini in Nylon a basso attrito. Supporto puleggia in Acciaio AISI 316 orientabile ( $\pm 50^\circ$ ). Puleggia in Alluminio con doppio cuscinetto laterale a sfere. Fermo d'arresto in Acciaio AISI 316 con posizione di disinserimento. Arricavo frontale.  
Carico di lavoro (SWL) 3800 Kg.  
Rotaia a T passo foratura 100 mm.  
Profilo in Alluminio ad alta resistenza anodizzato.  
Fissaggio con viti da 8 mm.

**antal**

Cod.	Ref	Rotaia	UM	€
<b>3722040</b>	Carrello		PZ	
<b>3722044</b>		40x8 - 2.0 m	PZ	
<b>3722045</b>		40x8 - 3.0 m	PZ	
<b>3722041</b>		Terminale rotaia	PZ	

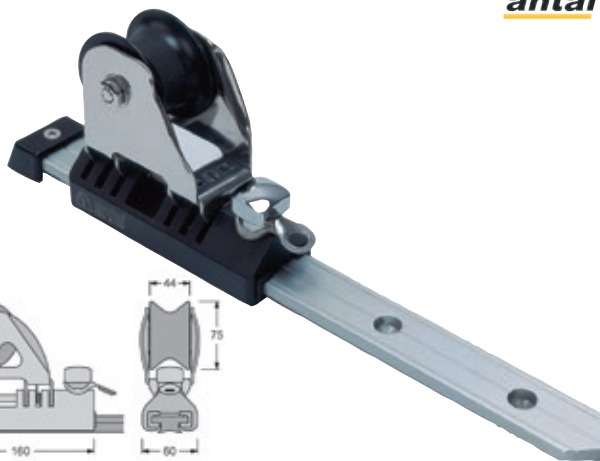
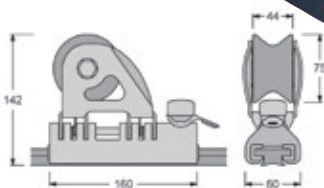
**Sistemi Randa Taglia 100 per Barche Sino a 33'**

Sistema carrello randa a sfere da 100.  
Dimensioni carrello: 62 x L98 mm. Carico di lavoro (SWL) 820 Kg.  
Monta sfere da 1/4" (50 sfere Torlon sulle piste inferiori e 50 Delrin su quelle superiori).  
Diametro pulegge laterali per il controllo del carrello: 35 mm.  
Il sistema è completo con rotaia e bozzello.

**antal**

Cod.	Ref	Paranco carrello	L Rotaia m	UM	€
<b>3723601</b>	Mod 4261	1:1	1.0	PZ	
<b>3723602</b>	Mod 4261	1:1	2.0	PZ	
<b>3723603</b>	Mod 4904	3:1	1.0	PZ	
<b>3723604</b>	Mod 4904	3:1	2.0	PZ	



**Carrello e Rotaia Genoa HS20**

Carrello e rotaia Genoa HS20 per imbarcazioni fino a 7.20 m (24')

Cod.	Ref	Rotaia	UM	€
3722001	Carrello con arresto		PZ	
3720015		1.50 m	PZ	
3720020		2.00 m	PZ	
3722002	Terminale rotaia		CP	

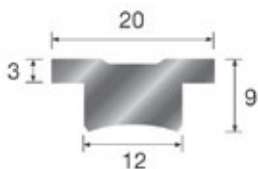
**Carrello e Rotaia Genoa HS25**

Carrello e rotaia Genoa HS25 per imbarcazioni fino a 10.20 m (34')

Cod.	Ref	Rotaia	UM	€
3722005	Carrello con arresto		PZ	
3720115		1.50 m	PZ	
3720120		2.00 m	PZ	
3722007	Terminale rotaia		CP	

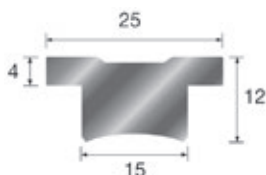
**Carrello e Rotaia Genoa HS32**

Carrello e rotaia Genoa HS32 per imbarcazioni fino a 13 m (43')

Cod.	Ref	Rotaia	UM	€
3722010	Carrello con arresto		PZ	
3720215		1.50 m	PZ	
3720220		2.00 m	PZ	
3722012	Terminale rotaia		CP	

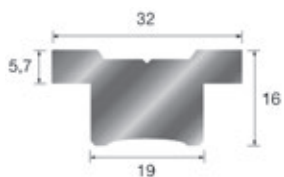
**Carrello Randa HS24 con Rotaie**

Carrello Randa HS24 per imbarcazioni fino a 9,60 m (32').

Le rotaie T21 basse necessitano di supporto, montano un terminale rotaia per lato.

Le rotaie L25 autoportanti non necessitano di supporto, montano due terminali rotaia per lato.

Cod.	Ref	Rotaia	UM	€
3722104	Carrello		PZ	
3722112	Terminali con strozza		CP	
3722152		T21 - 1.20 m	PZ	
3722155		T21 - 1.50 m	PZ	
3722158		T21 - 1.80 m	PZ	
3722162		L25 - 1.20 m	PZ	
3722165		L25 - 1.50 m	PZ	
3722168		L25 - 1.80 m	PZ	
3722121	Coppia terminali per rotaia		CP	



**Avvolgifiocco Bamar**

Avvolgifiocco manuale Bamar disponibile in varie taglie: C0, C0T, C1, C2, C3, C4. La rotazione del tamburo avvolgitore avviene su una doppia serie di sfere in Torlon che non richiedono lubrificazione o manutenzione. Il tamburo è cavo all'interno permettendo così l'installazione con strallo passante e l'alloggiamento del tenditore dello strallo all'interno.



Il Kit tamburo è completo di lande distanziatrici che possono essere tagliate a misura per modificare l'altezza della mura.

Il Kit profili comprende il profilo inferiore, un profilo intermedio da 1,5 m, giunti intermedi e di rinforzo, anello terminale, tappo e testa girevole.

Per un avvolgifiocco completo servono: 1 kit tamburo, 1 kit profili ed una serie di profili intermedi che aggiunti alla lunghezza kit profili portino la lunghezza totale uguale o superiore alla lunghezza dello strallo. Il profilo intermedio è completo di giunto.

Cod.	Tipo	Ref	Strallo mm	L max strallo m	UM	€
3782000	C0	Kit tamburo	4<>7	9	CF	
3782003	C0	Kit profili 2,5 m	4<>7		CF	
3782001	C0T	Kit tamburo	4<>7	10,5	CF	
3782004	C0T	Kit profili 2,5 m	4<>7		CF	
3782010	C1	Kit tamburo	5<>8	15	CF	
3782011	C1	Kit profili 2,5 m	5<>8		CF	
3782012	C0-C0T-C1	Profilo intermedio 1,5 m	4<>8		PZ	
3782020	C2	Kit tamburo	8<>10	18	CF	
3782021	C2	Kit profili 2,5 m	8<>10		CF	
3782030	C3	Kit tamburo	10<>12	19,5	CF	
3782031	C3	Kit profili 2,5 m	10<>12		CF	
3782032	C2 - C3	Profilo intermedio 1,5 m	8<>12		PZ	
3782040	C4	Kit tamburo	12<>14	21	CF	
3782041	C4	Kit profili 4,5 m	12<>14		CF	
3782042	C4	Profilo intermedio 1,5 m	12<>14		PZ	

**Accessori e Ricambi per Avvolgifiocco Bamar**

Accessori e ricambi per avvolgifiocco Bamar.

Cod.	Tipo	Ref	UM	€
3782060	C0	Profilo inferiore	CF	
3782061	C2 / C3	Profilo inferiore	CF	
3782072	C4	Profilo inferiore	CF	
3782064	C0 / C0T / C1	Giunto intermedio con rivetto	CF	
3782066	C2 / C3	Giunto intermedio con rivetto	CF	
3782062	C4	Giunto intermedio con rivetto	CF	
3782065	C0 / C0T / C1	Giunto di rinforzo senza rivetto	CF	
3782067	C2 / C3	Giunto di rinforzo senza rivetto	CF	
3782068	C0	Testa fissa con puleggia	CF	
3782069	C0T	Testa girevole	CF	
3782070	C1	Testa girevole	CF	
3782071	C2	Testa girevole	CF	

**Tendistrallo Bamar**

Tendistrallo meccanico Bamar resistente, potente, molto facile da installare e usare. Il modello compatto BTV a volantino è munito di bracci pieghevoli. L'attrito dovuto agli elevati carichi che si crea sulla filettatura è ridotto al minimo grazie alle bronzine autolubrificanti.

Il modello BTM si aziona con la manovella per winch ed è realizzato in Alluminio con le aste a doppio filo in Acciaio Inox, garantendo così una corsa maggiore.

Cod.	Ref	Strallo mm	L mm	Corsa mm	WL Kg	UM	€
3783005	BTV a volantino	5	420	140	1500	CF	
3783006	BTV a volantino	6	530	200	2300	CF	
3783008	BTM a manovella	8	900	300	4400	CF	
3783010	BTM a manovella	10	900	300	5000	CF	
3783012	BTM a manovella	12	950	300	7000	CF	





**Gennaker e Code 0 Furler Bamar**

Avvolgitore manuale Bamar per vele asimmetriche con bordo d'entrata libero come Spi Asimmetrico, Gennaker, MPS e Reacher. Costruito in Ergal, Acciaio 17-4PH e fibra di Carbonio che consentono una diminuzione del peso di carico del 60%. Composto da tamburo, testa girevole e dallo speciale kit strallo anti-torsione RollGen. Il tamburo ruota con una cima a circuito chiuso e può (tipo Code 0) essere utilizzato assieme alla testa per avvolgere vele con bordo d'entrata solidale allo strallo come Code 0, Drifter, ecc. Il tamburo EVO S è un avvolgitore per stralli strutturali e può contenere all'interno tutta la cima lasciando libero il ponte da ostacoli. Il luff control è un doppio girevole che consente la regolazione della tensione del bordo di entrata della vela.



Cod.	Tipo	Ref	L max strallo m	Accessori	UM	€
3787008	RLG-EVO 08	Kit tamburo Code 0	15		PZ	
3787009	RLG-EVO 08	Kit testa girevole Code 0	15		PZ	
3787038	RLG-EVO 08	Kit strallo RollGen	15		PZ	
3787058	RLG-EVO 08			Luff control	PZ	
3787010	RLG-EVO 10	Kit tamburo Code 0	17		PZ	
3787011	RLG-EVO 10	Kit testa girevole Code 0	17		PZ	
3787040	RLG-EVO 10	Kit strallo RollGen	17		PZ	
3787041	RLG-EVO 10	Kit strallo RollGen 3K	20		PZ	
3787060	RLG-EVO 10			Luff control	PZ	
3787061	RLG-EVO 10			Luff control 3K	PZ	
3787020	RLG-EVO 20	Kit tamburo Code 0	22		PZ	
3787032	RLG-EVO 20	Kit tamburo EVO S	22		PZ	
3787021	RLG-EVO 20	Kit testa girevole Code 0	22		PZ	
3787042	RLG-EVO 20	Kit strallo RollGen	22		PZ	
3787043	RLG-EVO 20	Kit strallo RollGen 3K	27		PZ	
3787070	RLG-EVO 20			Luff control	PZ	
3787071	RLG-EVO 20			Luff control 3K	PZ	
3787084				4 m kit cima 8 mm circuito chiuso	PZ	
3787086				6 m kit cima 8 mm circuito chiuso	PZ	
3787088				8 m kit cima 8 mm circuito chiuso	PZ	
3787090				10 m kit cima 8 mm circuito chiuso	PZ	
3787092				12 m kit cima 8 mm circuito chiuso	PZ	
3787093				12 m kit cima 10 mm circuito chiuso	PZ	

**Vang Bamar**

Vang meccanico Bamar con molla interna in Acciaio Inox che spinge il boma verso l'alto. Costruito in lega di Alluminio Anodizzato e speciali terminali d'attacco con pulegge incorporate in modo da formare un compatto paranco di cima rinviabile direttamente in pozzetto, oppure fissabile sul vang stesso utilizzando il paranco supplementare completo di strozza. La molla può regolare la spinta con la semplice rotazione del tubo/terminale superiore.



Cod.	Ref	L max	Diagonale con boma 90°	L imbarcazione	Accessori	UM	€
3786010	100	1600 mm	900<>1500 mm	9<>10.5 m		PZ	
3786020	200	2000 mm	1100<>2000 mm	10.5<>13.5 m		PZ	
3786030	300S	2000 mm	1250<>2000 mm	12.5<>16 m		PZ	
3786031	300	2500 mm	1400<>2350 mm	15<>17 m		PZ	
3786040					Attacco snodato albero mod 100	PZ	
3786044					Attacco snodato albero mod 200/300S	PZ	
3786048					Attacco snodato albero mod 300	PZ	
3786041					Attacco boma senza canaletta mod 100/200/300S	PZ	
3786042					Attacco boma con canaletta 20 mm mod 100	PZ	
3786045					Attacco boma con canaletta 25 mm mod 200	PZ	
3786043					Paranco supplementare con strozza mod 100	PZ	
3786046					Paranco supplementare con strozza mod 200	PZ	
3786047					Paranco supplementare con strozza mod 300S	PZ	
3786050					Paranco supplementare con strozza mod 300	PZ	



**Scotta MTM Classica da Crociera**

Ottima scotta da randa e da spi in Poliestere con spia colorata.  
Caratteristiche: Anima in doppia treccia di Poliestere prestirato.  
Calza in Poliestere da 20 fusi con grande resistenza all'abrasione.



Cod.	ø mm	Spia	daN	Metri	UM	€
3132406200	6	ROSSA	750	200	MT	
3142406200	6	BLU	750	200	MT	
3122406200	6	VERDE	750	200	MT	
3142606200	6	GIALLA	750	200	MT	
3132408200	8	ROSSA	1300	200	MT	
3142408200	8	BLU	1300	200	MT	
3122408200	8	VERDE	1300	200	MT	
3142608200	8	GIALLA	1300	200	MT	
3132410200	10	ROSSA	2100	200	MT	
3142410200	10	BLU	2100	200	MT	
3122410200	10	VERDE	2100	200	MT	
3142610200	10	GIALLA	2100	200	MT	
3132412200	12	ROSSA	2800	200	MT	
3142412200	12	BLU	2800	200	MT	
3122412200	12	VERDE	2800	200	MT	
3142612200	12	GIALLA	2800	200	MT	
3132414150	14	ROSSA	4100	150	MT	
3142414150	14	BLU	4100	150	MT	
3122414150	14	VERDE	4100	150	MT	
3142614150	14	GIALLA	4100	150	MT	
3132416100	16	ROSSA	5000	100	MT	
3142416100	16	BLU	5000	100	MT	
3122416100	16	VERDE	5000	100	MT	
3142616100	16	GIALLA	5000	100	MT	
3132418100	18	ROSSA	7200	100	MT	
3142418100	18	BLU	7200	100	MT	
3122418100	18	VERDE	7200	100	MT	
3142618100	18	GIALLA	7200	100	MT	

**Scotta MTM Colore da Crociera**

Ottima scotta da randa e da spi in Poliestere full-color con spia.  
Caratteristiche: Anima in doppia treccia di Poliestere prestirato.  
Calza in Poliestere da 20 fusi con grande resistenza all'abrasione.



Cod.	ø mm	Colore	daN	Metri	UM	€
3132506200	6	ROSSO	750	200	MT	
3142506200	6	BLU	750	200	MT	
3122506200	6	VERDE	750	200	MT	
3142626200	6	GIALLO	750	200	MT	
3132508200	8	ROSSO	1300	200	MT	
3142508200	8	BLU	1300	200	MT	
3122508200	8	VERDE	1300	200	MT	
3142628200	8	GIALLO	1300	200	MT	
3132510200	10	ROSSO	2100	200	MT	
3142510200	10	BLU	2100	200	MT	
3122510200	10	VERDE	2100	200	MT	
3142630200	10	GIALLO	2100	200	MT	
3132512200	12	ROSSO	2800	200	MT	
3142512200	12	BLU	2800	200	MT	
3122512200	12	VERDE	2800	200	MT	
3142632200	12	GIALLO	2800	200	MT	
3132514150	14	ROSSO	4100	150	MT	
3142514150	14	BLU	4100	150	MT	
3122514150	14	VERDE	4100	150	MT	
3142634150	14	GIALLO	4100	150	MT	



**Drizza MTM Classica da Crociera/Regata**

Ottima drizza per tutte le manovre correnti in Poliestere con spia colorata.

Caratteristiche: anima in doppia treccia di Poliestere prestirato.

Calza in Poliestere da 32 fusi con grande resistenza all'abrasione.

Cod.	ø mm	Spia	daN	Metri	UM	€
3133806200	6	ROSSA	1000	200	MT	
3143806200	6	BLU	1000	200	MT	
3153806200	6	VERDE	1000	200	MT	
3153906200	6	GIALLA	1000	200	MT	
3133808200	8	ROSSA	1800	200	MT	
3143808200	8	BLU	1800	200	MT	
3153808200	8	VERDE	1800	200	MT	
3153908200	8	GIALLA	1800	200	MT	
3133810200	10	ROSSA	2500	200	MT	
3143810200	10	BLU	2500	200	MT	
3153810200	10	VERDE	2500	200	MT	
3153910200	10	GIALLA	2500	200	MT	
3133812200	12	ROSSA	3200	200	MT	
3143812200	12	BLU	3200	200	MT	
3153812200	12	VERDE	3200	200	MT	
3153912200	12	GIALLA	3200	200	MT	
3133814150	14	ROSSA	4500	150	MT	
3143814150	14	BLU	4500	150	MT	
3153814150	14	VERDE	4500	150	MT	
3153914150	14	GIALLA	4500	150	MT	

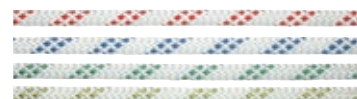
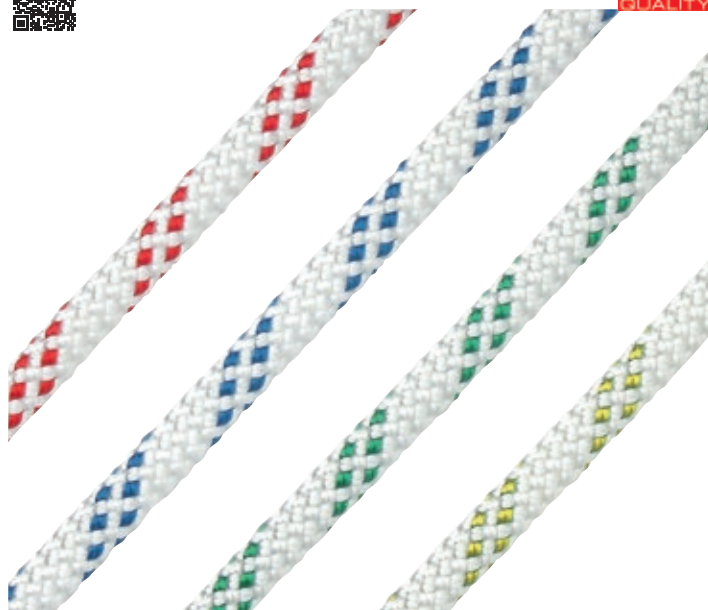

**Drizza MTM Colore da Crociera/Regata**

Ottima drizza per tutte le manovre correnti in Poliestere full-color con spia. Caratteristiche: anima in doppia treccia di Poliestere prestirato. Calza in Poliestere da 32 fusi con grande resistenza all'abrasione.

Cod.	ø mm	Colore	daN	Metri	UM	€
3133826200	6	ROSSO	1000	200	MT	
3143826200	6	BLU	1000	200	MT	
3153826200	6	VERDE	1000	200	MT	
3153926200	6	GIALLO	1000	200	MT	
3133828200	8	ROSSO	1800	200	MT	
3143828200	8	BLU	1800	200	MT	
3153828200	8	VERDE	1800	200	MT	
3153928200	8	GIALLO	1800	200	MT	
3133830200	10	ROSSO	2500	200	MT	
3143830200	10	BLU	2500	200	MT	
3153830200	10	VERDE	2500	200	MT	
3153930200	10	GIALLO	2500	200	MT	
3133832200	12	ROSSO	3200	200	MT	
3143832200	12	BLU	3200	200	MT	
3153832200	12	VERDE	3200	200	MT	
3153932200	12	GIALLO	3200	200	MT	
3133834150	14	ROSSO	4500	150	MT	
3143834150	14	BLU	4500	150	MT	
3153834150	14	VERDE	4500	150	MT	
3153934150	14	GIALLO	4500	150	MT	



**Liros Top-Cruising**

Scotta classica a basso allungamento (<5%) morbida, flessibile e resistente, adatta per imbarcazioni da crociera di ogni dimensione, ideale per randa, fiocco e spinnaker. Termofissata, facile da impiombare, non torce. Anima in treccia di Poliestere ad alta tenacità e calza in Poliestere resistente alle abrasioni.

Cod.	ø mm	Spia	daN	Metri	UM	€
3133006200	6	ROSSA	1100	200	MT	
3133007200	7	ROSSA	1300	200	MT	
3133008200	8	ROSSA	1650	200	MT	
3133010200	10	ROSSA	2700	200	MT	
3133012200	12	ROSSA	3200	200	MT	
3133014150	14	ROSSA	3800	150	MT	
3133016100	16	ROSSA	5000	100	MT	
3133106200	6	BLU	1100	200	MT	
3133107200	7	BLU	1300	200	MT	
3133108200	8	BLU	1650	200	MT	
3133110200	10	BLU	2700	200	MT	
3133112200	12	BLU	3200	200	MT	
3133114150	14	BLU	3800	150	MT	
3133116100	16	BLU	5000	100	MT	
3133206200	6	GIALLA	1100	200	MT	
3133207200	7	GIALLA	1300	200	MT	
3133208200	8	GIALLA	1650	200	MT	
3133210200	10	GIALLA	2700	200	MT	
3133212200	12	GIALLA	3200	200	MT	
3133214150	14	GIALLA	3800	150	MT	
3133216100	16	GIALLA	5000	100	MT	
3133306200	6	NERA	1100	200	MT	
3133307200	7	NERA	1300	200	MT	
3133308200	8	NERA	1650	200	MT	
3133310200	10	NERA	2700	200	MT	
3133312200	12	NERA	3200	200	MT	
3133314150	14	NERA	3800	150	MT	
3133316100	16	NERA	5000	100	MT	

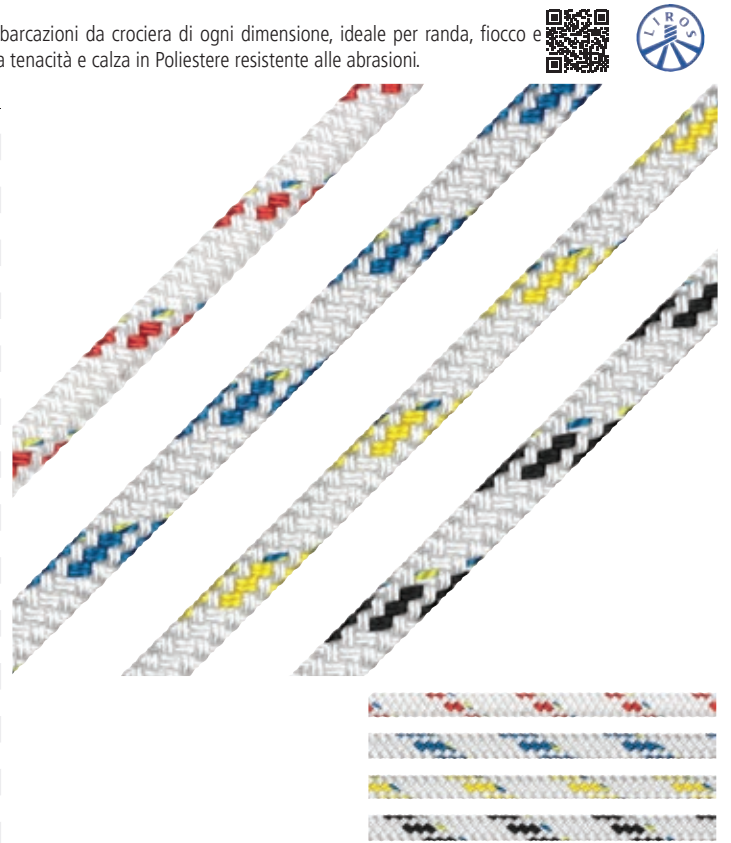
**Liros Herkules Colour**

Scotta/drizza di qualità a basso allungamento (<5%) molto versatile e resistente, adatta per imbarcazioni da crociera di ogni dimensione. La colorazione piena garantisce una facile identificazione della funzione della cima. Facile da impiombare, non torce. Anima in treccia di Poliestere ad alta tenacità e calza in Poliestere resistente alle abrasioni.

Cod.	ø mm	Colore	daN	Metri	UM	€
3142104250	4	ROSSO	400	250	MT	
3142105250	5	ROSSO	650	250	MT	
3142106200	6	ROSSO	800	200	MT	
3142108200	8	ROSSO	1600	200	MT	
3142110200	10	ROSSO	2500	200	MT	
3142112200	12	ROSSO	3500	200	MT	
3142114150	14	ROSSO	4500	150	MT	
3142116100	16	ROSSO	5000	100	MT	
3142304250	4	BLUE NAVY	400	250	MT	
3142305250	5	BLUE NAVY	650	250	MT	
3142306200	6	BLUE NAVY	800	200	MT	
3142308200	8	BLUE NAVY	1600	200	MT	
3142310200	10	BLUE NAVY	2500	200	MT	
3142312200	12	BLUE NAVY	3500	200	MT	
3142314150	14	BLUE NAVY	4500	150	MT	
3142316100	16	BLUE NAVY	5000	100	MT	
3142204250	4	GIALLO	400	250	MT	
3142205250	5	GIALLO	650	250	MT	
3142206200	6	GIALLO	800	200	MT	
3142208200	8	GIALLO	1600	200	MT	
3142210200	10	GIALLO	2500	200	MT	
3142212200	12	GIALLO	3500	200	MT	
3142214150	14	GIALLO	4500	150	MT	
3142216100	16	GIALLO	5000	100	MT	

**Liros Herkules Tradition Classic**

Scotta/drizza di alta qualità a basso allungamento (<5%) molto versatile e resistente, adatta per imbarcazioni classiche e vecchi armi di ogni dimensione. Facile da impiombare, non torce. Anima in treccia di Poliestere ad alta tenacità e calza in Poliestere resistente alle abrasioni. daN = carico di rottura in Kg.

Cod.	ø mm	daN	Metri	UM	€
3142004250	4	400	250	MT	
3142005250	5	650	250	MT	
3142006200	6	800	200	MT	
3142008200	8	1600	200	MT	
3142010200	10	2500	200	MT	
3142012200	12	3500	200	MT	
3142014150	14	4500	150	MT	
3142016100	16	5000	100	MT	

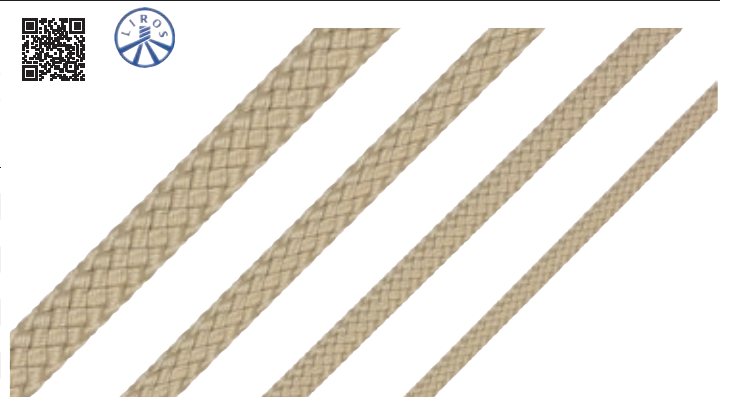

**Liros Seastar Colour**

Scotta "pelosa" di altissima qualità a basso allungamento (<6%) morbida, flessibile e con ottimo grip. Adatta per imbarcazioni da crociera e derivate, la colorazione piena garantisce una facile identificazione della funzione della cima. Termofissata, con anima in treccia di Poliestere e calza in Poliestere pettinato.

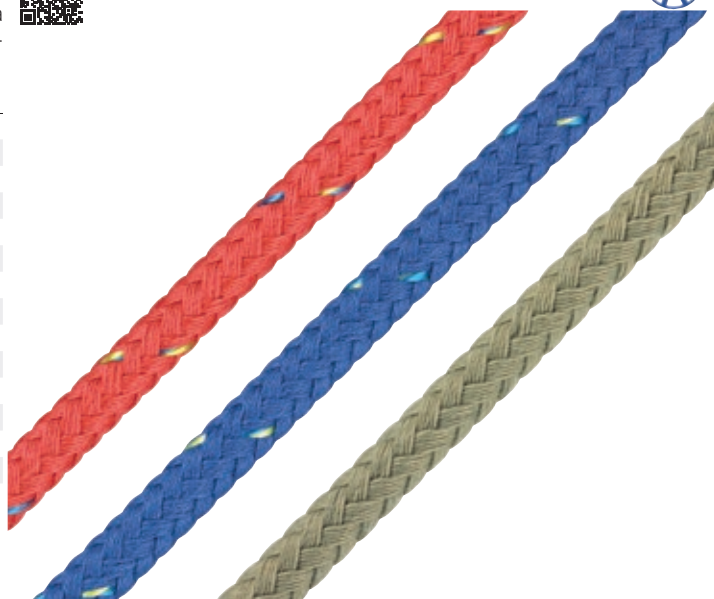

Cod.	ø mm	Colore	daN	Metri	UM	€
3132008200	8	ROSSO	1000	200	MT	
3132010200	10	ROSSO	1900	200	MT	
3132012200	12	ROSSO	2400	200	MT	
3132014150	14	ROSSO	2900	150	MT	
3132016100	16	ROSSO	3500	100	MT	
3132208200	8	BLUE	1000	200	MT	
3132210200	10	BLUE	1900	200	MT	
3132212200	12	BLUE	2400	200	MT	
3132214150	14	BLUE	2900	150	MT	
3132216100	16	BLUE	3500	100	MT	
3132308200	8	CANAPA	1000	200	MT	
3132310200	10	CANAPA	1900	200	MT	
3132312200	12	CANAPA	2400	200	MT	
3132314150	14	CANAPA	2900	150	MT	
3132316100	16	CANAPA	3500	100	MT	

**Liros Herkules Vision**

Scotta/drizza di ottima qualità a basso allungamento (<5%) molto versatile e resistente, adatta per imbarcazioni da crociera e regata. Cima facile da impiombare, non torce. Anima in treccia di Poliestere ad alta tenacità e calza in Poliestere resistente alle abrasioni.



Cod.	ø mm	Colore	daN	Metri	UM	€
3143006200	6	ROSSO	800	200	MT	
3143008200	8	ROSSO	1600	200	MT	
3143010200	10	ROSSO	2500	200	MT	
3143012200	12	ROSSO	3500	200	MT	
3143014150	14	ROSSO	4500	150	MT	
3143106200	6	BLU	800	200	MT	
3143108200	8	BLU	1600	200	MT	
3143110200	10	BLU	2500	200	MT	
3143112200	12	BLU	3500	200	MT	
3143114150	14	BLU	4500	150	MT	
3143206200	6	NERO	800	200	MT	
3143208200	8	NERO	1600	200	MT	
3143210200	10	NERO	2500	200	MT	
3143212200	12	NERO	3500	200	MT	
3143214150	14	NERO	4500	150	MT	
3143306200	6	ARANCIO	800	200	MT	
3143308200	8	ARANCIO	1600	200	MT	
3143310200	10	ARANCIO	2500	200	MT	
3143312200	12	ARANCIO	3500	200	MT	
3143314150	14	ARANCIO	4500	150	MT	

**Liros Dynamic Plus**

Scotta/drizza con allungamento minimo (<2%) leggera, performante e morbida, adatta per tutte le manovre correnti. Anima in Dyneema SK78 con guaina intermedia di protezione per facilitare l'impiombatura. Non torce grazie alla nuova calza in Poliestere a 32 fusi resistente alle abrasioni.



Cod.	ø mm	Spia	daN	Metri	UM	€
3143506200	6	ROSSA	1200	200	MT	
3143508200	8	ROSSA	2300	200	MT	
3143510200	10	ROSSA	3100	200	MT	
3143512200	12	ROSSA	4800	200	MT	
3143514150	14	ROSSA	6500	150	MT	
3143606200	6	BLU	1200	200	MT	
3143608200	8	BLU	2300	200	MT	
3143610200	10	BLU	3100	200	MT	
3143612200	12	BLU	4800	200	MT	
3143614150	14	BLU	6500	150	MT	
3143706200	6	GIALLA	1200	200	MT	
3143708200	8	GIALLA	2300	200	MT	
3143710200	10	GIALLA	3100	200	MT	
3143712200	12	GIALLA	4800	200	MT	
3143714150	14	GIALLA	6500	150	MT	
3143406200	6	VERDE	1200	200	MT	
3143408200	8	VERDE	2300	200	MT	
3143410200	10	VERDE	3100	200	MT	
3143412200	12	VERDE	4800	200	MT	
3143414150	14	VERDE	6500	150	MT	

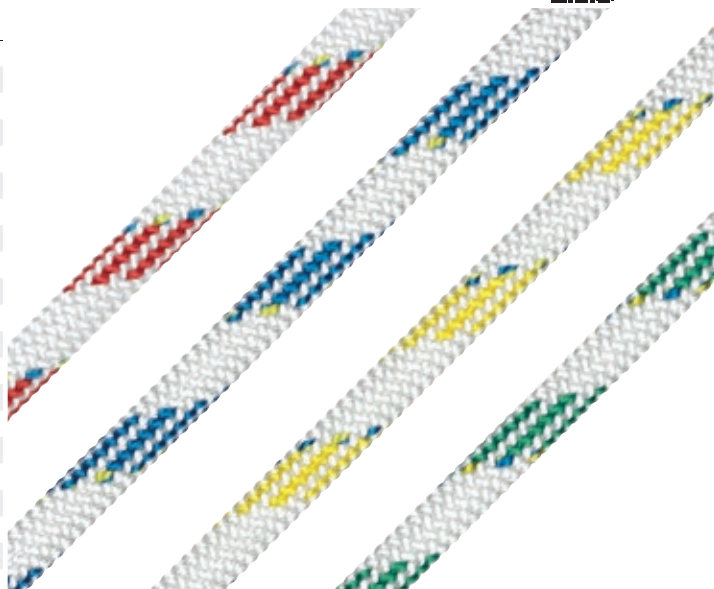

**Liros Dynamic Plus Color**

Scotta/drizza con allungamento minimo (<2%) leggera, performante e morbida, adatta per tutte le manovre correnti. Anima in Dyneema SK78 con guaina intermedia di protezione per facilitare l'impomatatura. Non torce grazie alla nuova calza in Poliestere a 32 fusi resistente alle abrasioni.

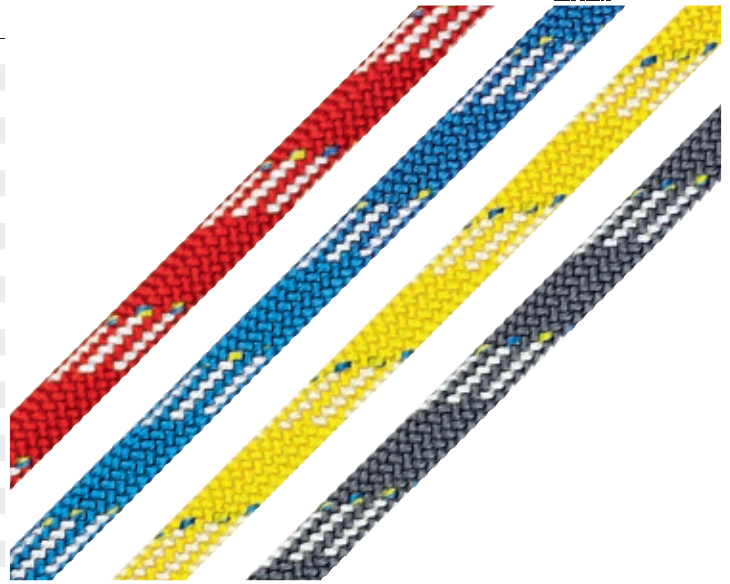

Cod.	ø mm	Colore	daN	Metri	UM	€
3147506200	6	ROSSO	1200	200	MT	
3147508200	8	ROSSO	2300	200	MT	
3147510200	10	ROSSO	3100	200	MT	
3147512200	12	ROSSO	4800	200	MT	
3147514150	14	ROSSO	6500	150	MT	
3147606200	6	BLU	1200	200	MT	
3147608200	8	BLU	2300	200	MT	
3147610200	10	BLU	3100	200	MT	
3147612200	12	BLU	4800	200	MT	
3147614150	14	BLU	6500	150	MT	
3147706200	6	GIALLO	1200	200	MT	
3147708200	8	GIALLO	2300	200	MT	
3147710200	10	GIALLO	3100	200	MT	
3147712200	12	GIALLO	4800	200	MT	
3147714150	14	GIALLO	6500	150	MT	
3147806200	6	GRIGIO STEEL	1200	200	MT	
3147808200	8	GRIGIO STEEL	2300	200	MT	
3147810200	10	GRIGIO STEEL	3100	200	MT	
3147812200	12	GRIGIO STEEL	4800	200	MT	
3147814150	14	GRIGIO STEEL	6500	150	MT	

**Liros Regatta 2000**

Scotta/drizza con allungamento minimo (<1,5%) e carico di rottura molto elevato. Leggera e molto resistente è adatta per tutte le manovre correnti. Anima in Dyneema SK78 con guaina intermedia di protezione per una migliore impomatatura ed una perfetta connessione tra anima e calza. Calza in Poliestere High-Performance con estrema resistenza alle abrasioni.



Cod.	ø mm	Spia	daN	Metri	UM	€
3146504250	4	ROSSA	800	250	MT	
3146505250	5	ROSSA	1100	250	MT	
3146506200	6	ROSSA	2500	200	MT	
3146508200	8	ROSSA	3800	200	MT	
3146510200	10	ROSSA	5000	200	MT	
3146512200	12	ROSSA	7200	200	MT	
3146514150	14	ROSSA	9500	150	MT	
3146516100	16	ROSSA	12800	100	MT	
3146604250	4	BLU	800	250	MT	
3146605250	5	BLU	1100	250	MT	
3146606200	6	BLU	2500	200	MT	
3146608200	8	BLU	3800	200	MT	
3146610200	10	BLU	5000	200	MT	
3146612200	12	BLU	7200	200	MT	
3146614150	14	BLU	9500	150	MT	
3146616100	16	BLU	12800	100	MT	
3146704250	4	GIALLA	800	250	MT	
3146705250	5	GIALLA	1100	250	MT	
3146706200	6	GIALLA	2500	200	MT	
3146708200	8	GIALLA	3800	200	MT	
3146710200	10	GIALLA	5000	200	MT	
3146712200	12	GIALLA	7200	200	MT	
3146714150	14	GIALLA	9500	150	MT	
3146716100	16	GIALLA	12800	100	MT	
3146804250	4	BIANCA	800	250	MT	
3146805250	5	BIANCA	1100	250	MT	
3146806200	6	BIANCA	2500	200	MT	
3146808200	8	BIANCA	3800	200	MT	
3146810200	10	BIANCA	5000	200	MT	
3146812200	12	BIANCA	7200	200	MT	
3146814150	14	BIANCA	9500	150	MT	
3146816100	16	BIANCA	12800	100	MT	
3146904250	4	ARANCIO	800	250	MT	
3146905250	5	ARANCIO	1100	250	MT	
3146906200	6	ARANCIO	2500	200	MT	
3146908200	8	ARANCIO	3800	200	MT	
3146910200	10	ARANCIO	5000	200	MT	
3146912200	12	ARANCIO	7200	200	MT	
3146914150	14	ARANCIO	9500	150	MT	
3146916100	16	ARANCIO	12800	100	MT	

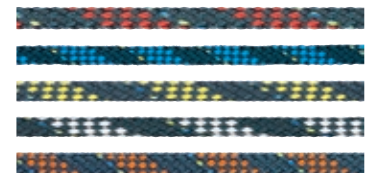

**Liros Racer Vision**

Scotta/drizza high-tech con allungamento minimo (<1,5%) e carico di rottura molto elevato. Facile da impiombare, molto leggera, ideale per winch e stoppers grazie alla elevata resistenza all'abrasione. Calza in Poliestere SteelBlue ad alta torsione a 32 fusi resistente all'abrasione. Anima in Dyneema a 12 fusi con trattamento grip XTR.

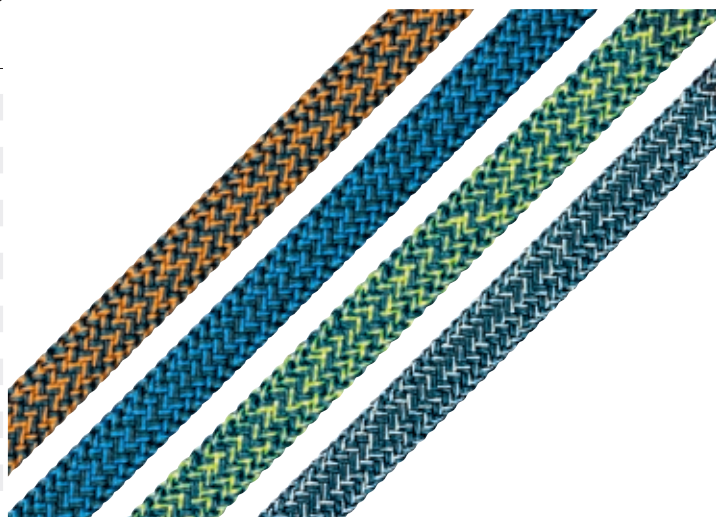

Cod.	ø mm	Colore	daN	Metri	UM	€
3145608200	8	ARANCIO	4200	200	MT	
3145610200	10	ARANCIO	5500	200	MT	
3145612200	12	ARANCIO	8000	200	MT	
3145614150	14	ARANCIO	10500	150	MT	
3145708200	8	BLU	4200	200	MT	
3145710200	10	BLU	5500	200	MT	
3145712200	12	BLU	8000	200	MT	
3145714150	14	BLU	10500	150	MT	
3145808200	8	GIALLO	4200	200	MT	
3145810200	10	GIALLO	5500	200	MT	
3145812200	12	GIALLO	8000	200	MT	
3145814150	14	GIALLO	10500	150	MT	
3145908200	8	SILVER	4200	200	MT	
3145910200	10	SILVER	5500	200	MT	
3145912200	12	SILVER	8000	200	MT	
3145914150	14	SILVER	10500	150	MT	

**Liros Racer-XTR**

Scotta/drizza con allungamento minimo (<1%) e carico di rottura elevatissimo. Utilizzata in competizione dai migliori regatanti, perfetta con strozzatori potenti e stoppers sotto carico. Calza in fibra ibrida a 32 fusi estremamente resistente all'abrasione anche ad alta temperatura. Anima in Dyneema SK78 a 12 fusi con trattamento grip XTR.



Cod.	ø mm	Colore	daN	Metri	UM	€
3144908200	8	BIANCO/STEEL BLUE	4700	200	MT	
3144910200	10	BIANCO/STEEL BLUE	6900	200	MT	
3144912200	12	BIANCO/STEEL BLUE	9900	200	MT	
3144914150	14	BIANCO/STEEL BLUE	13000	150	MT	
3144808200	8	BIANCO/ARANCIO	4700	200	MT	
3144810200	10	BIANCO/ARANCIO	6900	200	MT	
3144812200	12	BIANCO/ARANCIO	9900	200	MT	
3144814150	14	BIANCO/ARANCIO	13000	150	MT	

**Liros Control-XTR**

Cima con allungamento minimo (<1%) di qualità ed eccellenza estreme, perfetta per stoppers e winches. Grip eccezionale, resistenza totale all'abrasione e alle temperature elevate. Calza in Technora e Poliestere ad alta tenacità a 32 fusi con Aramide che ne impedisce la fusione ad alta temperatura. Anima in Dyneema SK99 prestirato con sistema Liros HSS e LCS con Grip Coating che garantisce il trasporto del carico dell'anima sulla calza.



Cod.	ø mm	Colore	daN	Metri	UM	€
3147110100	10	ROSSO	8000	100	MT	
3147112100	12	ROSSO	11200	100	MT	
3147114100	14	ROSSO	14100	100	MT	
3147116100	16	ROSSO	17500	100	MT	
3147118100	18	ROSSO	20400	100	MT	
3147310100	10	BLU	8000	100	MT	
3147312100	12	BLU	11200	100	MT	
3147314100	14	BLU	14100	100	MT	
3147316100	16	BLU	17500	100	MT	
3147318100	18	BLU	20400	100	MT	
3147010100	10	BIANCO	8000	100	MT	
3147012100	12	BIANCO	11200	100	MT	
3147014100	14	BIANCO	14100	100	MT	
3147016100	16	BIANCO	17500	100	MT	
3147018100	18	BIANCO	20400	100	MT	
3147210100	10	VERDE	8000	100	MT	
3147212100	12	VERDE	11200	100	MT	
3147214100	14	VERDE	14100	100	MT	
3147216100	16	VERDE	17500	100	MT	
3147218100	18	VERDE	20400	100	MT	



**Liros Magic Edge**

Cima performante con allungamento minimo (<1,5%) ideale per tutte le applicazioni in gare e regate. Calza in Poliestere compatta e molto resistente alle abrasioni. I diametri 1,5 e 2 vengono forniti con colore pieno senza spia. Anima in Dyneema SK78.

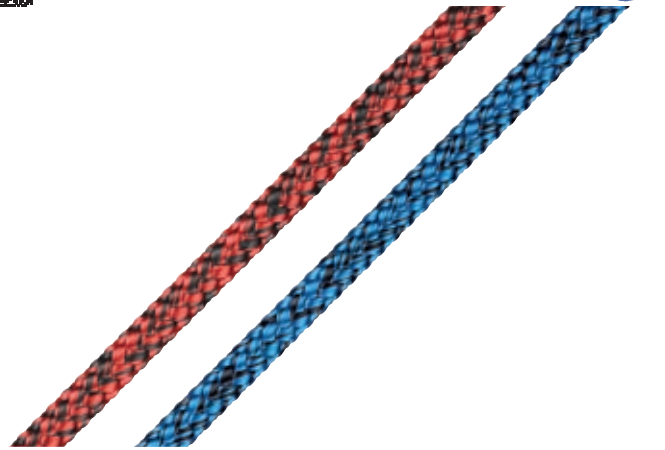

Cod.	ø mm	Colore	daN	Metri	UM	€
3143901100	1,5	ROSSO	125	100	MT	
3143902100	2	ROSSO	240	100	MT	
3143903100	3	ROSSO	420	100	MT	
3143904100	4	ROSSO	580	100	MT	
3143905100	5	ROSSO	1050	100	MT	
3143906100	6	ROSSO	1800	100	MT	
3144001100	1,5	BLU	125	100	MT	
3144002100	2	BLU	240	100	MT	
3144003100	3	BLU	420	100	MT	
3144004100	4	BLU	580	100	MT	
3144005100	5	BLU	1050	100	MT	
3144006100	6	BLU	1800	100	MT	

**Liros Magic Sport**

Cima tecnica multiuso a basso allungamento (<5%) in Neon-Design ideale per derive e piccole imbarcazioni da regata. Molto resistente all'abrasione, con anima in Poliestere ad alta tenacità a 16 fusi termofissati.

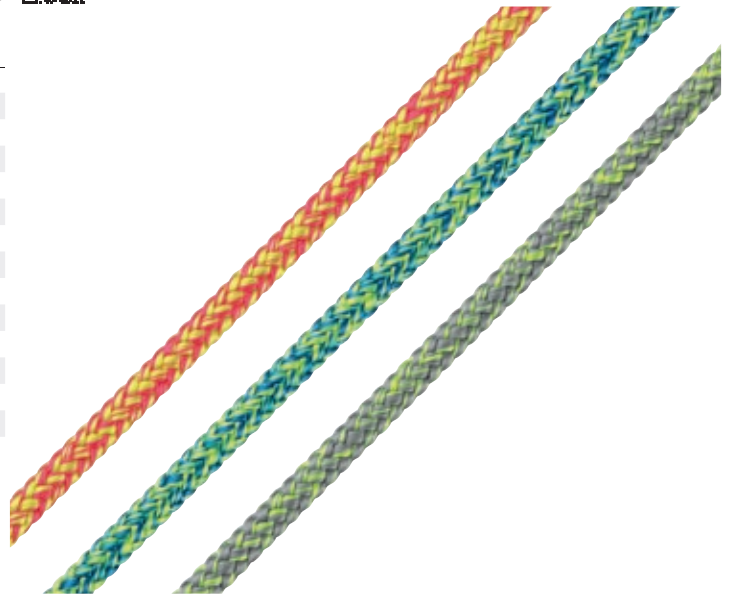

Cod.	ø mm	Colore	daN	Metri	UM	€
3144202100	2	ROSSO	95	100	MT	
3144203100	3	ROSSO	185	100	MT	
3144204100	4	ROSSO	550	100	MT	
3144205100	5	ROSSO	850	100	MT	
3144206100	6	ROSSO	1000	100	MT	
3144402100	2	BLUE	95	100	MT	
3144403100	3	BLUE	185	100	MT	
3144404100	4	BLUE	550	100	MT	
3144405100	5	BLUE	850	100	MT	
3144406100	6	BLUE	1000	100	MT	
3144302100	2	SILVER	95	100	MT	
3144303100	3	SILVER	185	100	MT	
3144304100	4	SILVER	550	100	MT	
3144305100	5	SILVER	850	100	MT	
3144306100	6	SILVER	1000	100	MT	

**Liros Magic Pro**

Scotta/drizza con allungamento minimo utilizzata in competizione da derive e catamarani. Garantisce una tenuta eccezionale su strozzatori, bozzelli e stoppers grazie al fattore grip molto alto, mentre la coesione tra anima e calza permette la massima rapidità nelle manovre. Calza in Poliestere Grip ad alta tenacità. Anima in Dyneema SK78 con speciale trattamento grip XTR.



Cod.	ø mm	Colore	daN	Metri	UM	€
3145003100	3	ROSSO	450	100	MT	
3145004100	4	ROSSO	620	100	MT	
3145005100	5	ROSSO	1250	100	MT	
3145006100	6	ROSSO	1600	100	MT	
3145008100	8	ROSSO	3000	100	MT	
3145103100	3	BLU	450	100	MT	
3145104100	4	BLU	620	100	MT	
3145105100	5	BLU	1250	100	MT	
3145106100	6	BLU	1600	100	MT	
3145108100	8	BLU	3000	100	MT	
3145203100	3	NERO	450	100	MT	
3145204100	4	NERO	620	100	MT	
3145205100	5	NERO	1250	100	MT	
3145206100	6	NERO	1600	100	MT	
3145208100	8	NERO	3000	100	MT	
3145303100	3	GIALLO	450	100	MT	
3145304100	4	GIALLO	620	100	MT	
3145305100	5	GIALLO	1250	100	MT	
3145306100	6	GIALLO	1600	100	MT	
3145308100	8	GIALLO	3000	100	MT	





**Liros D-Pro**

Cima senza calza per applicazioni estreme con allungamento minimo (<1%) utilizzata su tutti i tipi di imbarcazioni da gara. Leggera, facile da impiombare, resistente all'abrasione e con carico di rottura più alto di un cavo d'acciaio dello stesso diametro.

Costruzione in Dyneema SK78 impregnato a 12 fusi.

Cod.	ø mm	daN	Metri	UM	€
3145501100	1	195	100	MT	
3145515100	1,5	230	100	MT	
3145502100	2	410	100	MT	
3145525100	2,5	580	100	MT	
3145503100	3	950	100	MT	
3145504100	4	1300	100	MT	
3145505100	5	2600	100	MT	
3145506100	6	4300	100	MT	
3145508100	8	5300	100	MT	
3145510100	10	9000	100	MT	
3145512100	12	11900	100	MT	

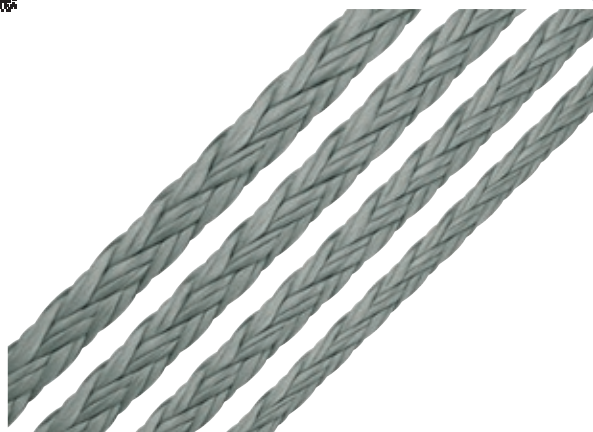
**Liros Slide Protect-XTR**

Calza molto scorrevole per protezione supplementare contro l'abrasione, raccomandata per tutte le cime che lavorano su passaggi di pulegge e rinvii. Da non usare su stopper e winches data la frizione ridotta della calza. Costruzione in Dyneema SK78 impregnato a 48 fusi.

Cod.	Per cima ø mm	Metri	UM	€
3146105100	3<>6	25	MT	
3146108100	5<>10	25	MT	
3146112100	8<>12	25	MT	
3146116100	14<>22	25	MT	

**Liros Grip Protect-XTR**

Calza per protezione supplementare contro l'abrasione, raccomandata per tutte le cime che lavorano su stoppers e winches. Ha un grip eccezionale, garantisce il trasporto del carico tra la cima e la calza evitando slittamenti. Costruzione in Technora a 48 fusi con Aramide che ne impedisce la fusione ad alta temperatura.

Cod.	Per cima ø mm	Metri	UM	€
3146005100	3<>6	25	MT	
3146008100	5<>10	25	MT	
3146012100	8<>14	25	MT	
3146016100	12<>22	25	MT	

**Liros Soft Shackles**

Grilli in treccia che sostituiscono grilli e moschettoni in metallo per collegare scotte, drizze e bozzelli, si usano anche per applicazioni industriali. Apertura veloce, semplice e sicura tramite la cinghia Liros, evita incidenti e danni sul ponte. Costruiti in resistente Dyneema SK78, sono colorati in base al carico di rottura per una facile identificazione.

Cod.	ø mm	Colore	Carico di rottura Kg	UM	€
3109004	6	BIANCO	1000	PZ	
3109005	8	NERO	1500	PZ	
3109006	10	ROSSO	2000	PZ	
3109008	12	BLU	4000	PZ	
3109010	14	GIALLO	6000	PZ	



**Treccia Liros Polyamide Braid**

Treccia per usi vari e legature resistente all'abrasione, flessibile ed elastica (<15%). Costruzione e materiali: Polyamide ad alta tenacità resistente UV trecciato a 8 fusi.



Cod.	ø mm	daN	m	UM	€
3104502100	2	100	100	MT	
3104503100	3	180	100	MT	
3104505100	5	550	100	MT	
3104506100	6	850	100	MT	

**Treccia Multiuso**

Treccia in multifilo stabilizzato per usi vari e legature. Costruzione e materiali: 8 fusi e 100% Polietilene di alta qualità.



Cod.	ø mm	daN	m	UM	€
3103502100	2	90	100	MT	
3103503100	3	130	100	MT	
3103504100	4	220	100	MT	
3103505100	5	340	100	MT	
3103506100	6	500	100	MT	

**Treccia Lapo**

Treccia da ormeggio e ancoraggio economica multiuso. Lavorazione a 16 fusi di Poliestere con spia. Non galleggia.

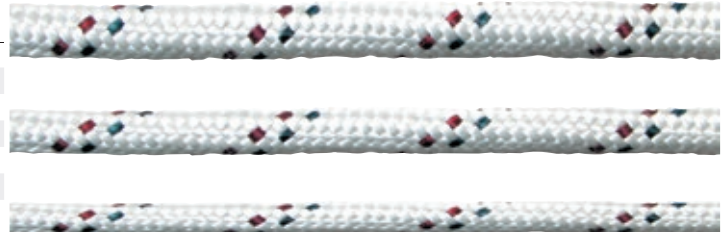

Cod.	ø mm	daN	m	UM	€
3101504500	4	190	500	MT	
3101505400	5	275	400	MT	
3101506200	6	500	200	MT	
3101508200	8	840	200	MT	
3101510200	10	1200	200	MT	
3101512200	12	1400	200	MT	
3101514100	14	1600	100	MT	

**Treccia Galleggiante Arancio**

Treccia resistente e leggera per tientibene, salvagenti, ormeggio etc. 3 fusi - 100% Polietilene. Galleggia.

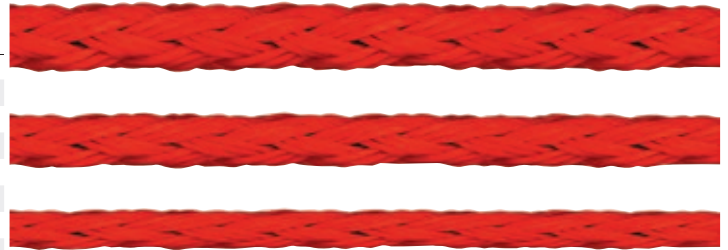

Cod.	ø mm	daN	m	UM	€
3101006200	6	300	200	MT	
3101008200	8	400	200	MT	
3101010200	10	500	200	MT	
3101012200	12	800	200	MT	
3101014100	14	1100	100	MT	
3101016100	16	1400	100	MT	
3101018100	18	1800	100	MT	
3101020100	20	2200	100	MT	

**Treccia Galleggiante Nera**

Treccia resistente e leggera per tientibene, salvagenti, ormeggio etc. 3 Fusi 100% Polietilene. Galleggia.



Cod.	ø mm	daN	m	UM	€
3101206200	6	300	200	MT	
3101208200	8	400	200	MT	
3101210200	10	500	200	MT	
3101212200	12	800	200	MT	
3101214100	14	1100	100	MT	
3101216100	16	1400	100	MT	
3101218100	18	1800	100	MT	
3101220100	20	2200	100	MT	

**Treccia Galleggiante Grigia**

Treccia in multifilo per usi vari, ideale per gommoni e tender.

Morbida e leggera, galleggia, non assorbe l'umidità.

Costruzione e materiali: 16 fusi, 100% Polietilene stabilizzato UV.



Cod.	ø mm	daN	m	UM	€
3101308200	8	700	200	MT	
3101310200	10	1000	200	MT	
3101312200	12	1300	200	MT	
3101314150	14	1800	150	MT	
3101316100	16	2000	100	MT	



**Portacime strap**

Portacime per scotte e drizze in tessuto acrilico idrorepellente e resistente ai raggi UV. I colori indelebili stabilizzati restano vivaci per almeno 3 anni di utilizzo continuo.

Facile installazione grazie al velcro interno, permette di ordinare le cime in maniera compatta e veloce.

Cod.	Dim cm	Colore	UM	€
<b>3215639</b>	8 x 13	BLU NAVY	PZ	
<b>3215640</b>	8 x 13	GRIGIO	PZ	

**Sacca Portacime Navishell Small**

Sacca per scotte e drizze in tessuto acrilico idrorepellente e resistente ai raggi UV. I colori indelebili stabilizzati restano vivaci per almeno 3 anni di utilizzo continuo.

Due i sistemi di fissaggio a scelta in dotazione:

- 1) Con le ventose che garantiscono un facile e sicuro fissaggio senza forare
- 2) Con i gancetti che garantiscono un facile e sicuro fissaggio forando la parete

Cod.	Dim cm	Colore	UM	€
<b>3215601</b>	30 x 11 x H18	BLU NAVY	PZ	
<b>3215602</b>	30 x 11 x H18	GRIGIO	PZ	

**Sacca Portacime Navishell Large**

Sacca per scotte e drizze in tessuto acrilico idrorepellente e resistente ai raggi UV. I colori indelebili stabilizzati restano vivaci per almeno 3 anni di utilizzo continuo.

Due i sistemi di fissaggio a scelta in dotazione:

- 1) Con le ventose che garantiscono un facile e sicuro fissaggio senza forare
- 2) Con i gancetti che garantiscono un facile e sicuro fissaggio forando la parete

Cod.	Dim cm	Colore	UM	€
<b>3215604</b>	35 x 13 x H24	BLU NAVY	PZ	
<b>3215605</b>	35 x 13 x H24	GRIGIO	PZ	

**Sacca Portacime Navishell Deep**

Sacca per scotte e drizze in tessuto acrilico idrorepellente e resistente ai raggi UV. I colori indelebili stabilizzati restano vivaci per almeno 3 anni di utilizzo continuo.

Due i sistemi di fissaggio a scelta in dotazione:

- 1) Con le ventose che garantiscono un facile e sicuro fissaggio senza forare
- 2) Con i gancetti che garantiscono un facile e sicuro fissaggio forando la parete

Cod.	Dim cm	Colore	UM	€
<b>3215607</b>	36 x 10 x H30	BLU NAVY	PZ	
<b>3215608</b>	36 x 10 x H30	GRIGIO	PZ	

**Sacca Portacime Battagliola & Pozzetto Navishell**

Sacca per scotte e drizze in tessuto acrilico idrorepellente e resistente ai raggi UV. I colori indelebili stabilizzati restano vivaci per almeno 3 anni di utilizzo continuo.

Tre i sistemi di fissaggio a scelta in dotazione:

- 1) Sulla battagliola con il Velcro che garantisce un facile e sicuro fissaggio
- 2) In pozzetto con le ventose che garantiscono un facile e sicuro fissaggio senza forare
- 3) In pozzetto con i gancetti che garantiscono un facile e sicuro fissaggio forando la parete

Cod.	Dim cm	Colore	UM	€
<b>3215610</b>	40 x 20 x H28	BLU NAVY	PZ	
<b>3215611</b>	40 x 20 x H28	GRIGIO	PZ	



**Bobinette Liros Treccine Poliestere**

Scatola di colori assortiti di bobinette di treccia in Poliestere. Estremamente resistente, molto flessibile, resistente raggi UV, non indurisce nel tempo.



Cod.	ø mm	Confezione	UM	€
3106532	2	10 x 30 m	PZ	
3106533	3	10 x 15 m	PZ	
3106534	4	5 x 10 m	PZ	

**Bobinette Liros Magic Speed**

Scatola di colori assortiti di bobinette di treccia in Poliestere con calza a 16 fusi. Resistentissima alle abrasioni, alta tenuta su gallocc e minimo allungamento. Ideale per scottine, legature, derive e mille altri usi a bordo.



Cod.	ø mm	Confezione	UM	€
3105112	2	10 x 30 m	PZ	
3105113	3	10 x 15 m	PZ	

**Bobinette Liros Optisail**

Bobinette di treccia in Dyneema SK78 con calza in Poliestere a 16 fusi. Estremamente resistente, flessibile, allungamento minimo (<1,5%), perfetta tenuta ai nodi.



Cod.	ø mm	L metri	UM	€
3106612	1,2	20	PZ	

**Bobinette Multicolor in Poliestere**

Bobinette di treccia in Poliestere multicolore. Ideali per scottine, sagole, legature e mille altri usi a bordo.



Cod.	Colore	ø mm	L m	Accessori	UM	€
3105032	GIALLO	2	30		PZ	
3105013	GIALLO	3	15		PZ	
3105232	ROSSO	2	30		PZ	
3105213	ROSSO	3	15		PZ	
3105432	BLUE	2	30		PZ	
3105413	BLUE	3	15		PZ	
3105632	VERDE	2	30		PZ	
3105613	VERDE	3	15		PZ	
3105031				Espositore per 10 bobine	PZ	

**Bobinette Multicolor in Dyneema**

Bobinette hi-tech di treccia in Dyneema multicolore. Ideali per scottine, drizze, sagole, legature e mille altri usi a bordo.



Cod.	Colore	ø mm	L m	Accessori	UM	€
3107001	BLUE	1	40		PZ	
3107002	BLUE	2	30		PZ	
3107003	BLUE	3	15		PZ	
3107011	ROSSO	1	40		PZ	
3107012	ROSSO	2	30		PZ	
3107013	ROSSO	3	15		PZ	
3107021	GIALLO	1	40		PZ	
3107022	GIALLO	2	30		PZ	
3107023	GIALLO	3	15		PZ	
3105031				Espositore per 10 bobine	PZ	



**Bobinette Fullcolor**

Bobinette di treccina in Polipropilene tutto colore. Ideali per sagole, legature e mille altri usi a bordo.



MTM

Cod.	Colore	ø mm	L m	Accessori	UM	€
3106032	BLUE	2	30		PZ	
3106042	BLUE con spia	2	30		PZ	
3106033	BLUE	3	15		PZ	
3106043	BLUE con spia	3	15		PZ	
3106232	ROSSO	2	30		PZ	
3106242	ROSSO con spia	2	30		PZ	
3106233	ROSSO	3	15		PZ	
3106243	ROSSO con spia	3	15		PZ	
3106332	GIALLO	2	30		PZ	
3106342	GIALLO con spia	2	30		PZ	
3106333	GIALLO	3	15		PZ	
3106343	GIALLO con spia	3	15		PZ	
3105031				Espositore per 10 bobine	PZ	

**Bobinette All Black**

Bobinette di treccina in Poliestere Nero. Ideali per sagole, legature e mille altri usi a bordo.



MTM

Cod.	ø mm	L m	Accessori	UM	€
3105921	1	40		PZ	
3105922	2	30		PZ	
3105923	3	15		PZ	
3105031			Espositore per 10 bobine	PZ	

**Bobinette All White**

Bobinette di treccina in Poliestere Bianco. Ideali per sagole, legature e mille altri usi a bordo.



MTM

Cod.	ø mm	L m	Accessori	UM	€
3105901	1	40		PZ	
3105902	2	30		PZ	
3105903	3	15		PZ	
3105031			Espositore per 10 bobine	PZ	

**Treccia di Avviamento per Motori Fuoribordo**

Treccia di avviamento per motori fuoribordo.

Costruzione e materiali: 16 fusi. 100% Poliestere alta tenacità.



MTM

Cod.	ø mm	L m	UM	€
3104035	3	100	MT	
3104040	4	100	MT	
3104050	5	100	MT	

**Bobinette per Fucili Subacquei**

Treccia per fucili subacquei. Costruzione e materiali: 16 fusi. 100% Poliestere alta tenacità.



MTM

Cod.	ø mm	L m	UM	€
3104215	1,5	40	PZ	
3104220	2,0	40	PZ	

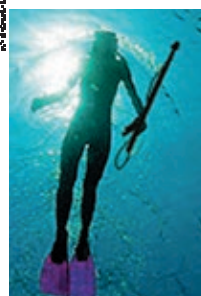

**Tagliacorde a Fusione**

Tagliacorde elettrico 220V - 60W per tagliare a fusione corde e trecce. Adatto anche al taglio di vele, tende, cinghie, nastri e tessuti sintetici.



Cod.	Ref	UM	€
3190001	Tagliacorde	PZ	
3190002	Lama ricambio	PZ	

**Tagliacorde a Fusione Pro**

Tagliacorde elettrico professionale per uso continuo 220V - 120W. Raggiunge 500°C in pochi secondi e taglia velocemente cime, corde e trecce anche di grosso diametro. Si raffredda subito grazie al sistema di raffreddamento a ricircolo d'aria. Adatto anche per tagliare vele, tende, cinghie, nastri e qualsiasi tessuto sintetico. Completo di lama, spazzola per pulire residui e cavo da 3 metri. Fornito con valigetta portatile.



Cod.	Ref	UM	€
3190005	Tagliacorde	PZ	
3190002	Lama ricambio	PZ	
3190006	Lama accessoria taglia cinghie	PZ	

**Tagliacorde a Fusione a Batteria**

Tagliacorde elettrico portatile a batteria ricaricabile. Raggiunge 400°C in pochi secondi e taglia velocemente cime, corde e trecce anche di grosso diametro. Adatto anche per tagliare vele, tende, cinghie, nastri e qualsiasi tessuto sintetico. Completo di lama, spazzola per pulire residui, batteria ricaricabile e caricabatterie. Fornito con valigetta portatile.



Cod.	Ref	UM	€
3190003	Tagliacorde	PZ	
3190002	Lama ricambio	PZ	
3190006	Lama accessoria taglia cinghie	PZ	
3190004	Batteria ricambio	PZ	

**Forbici Kevlar-Dyneema**

Forbici tagliacime con speciale lama seghettata in lega di Acciaio e Carbonio particolarmente adatta per il taglio delle cime in Dyneema, per il Kevlar e per tutti i materiali tessili più duri.



Cod.	UM	€
3191090	PZ	

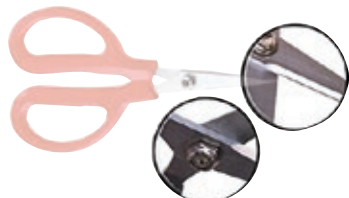

**Liros Rigger Bag Splicing Kit**

Borsa kit con tutti gli attrezzi e gli accessori necessari per le impiombature del cordame. Perfetta per professionisti e per velisti fai da te.

Cod.	UM	€
3191006	CF	

**Caviglie Inox**

Caviglie in Acciaio Inox con manico in legno per impiombare cordame e sciogliere nodi.

Cod.	L cm	UM	€
5830701	17,5	PZ	
5830702	26,5	PZ	

**Set di Aghi per Impiombature**

Set di 4 aghi in Acciaio Inossidabile per impiombature.

Lunghezze aghi mm: 120/140/180/220.

Rispettivi diametri mm: 5/7/9/12.

Cod.	UM	€
3191000	CF	

**Aghi Liros Splicer Pro**

Aghi in Acciaio 304 perfetti per impiombature su cime con calza.

Cod.	Misura	Impiombatura mm	L cm	UM	€
3191008	Small	6-8	15	CF	
3191009	Medium	10-12	30	CF	
3191010	Large	12-18	34	CF	

**Filo per Impiombature in Poliestere Paraffinato**

Filo bianco per impiombature in Poliestere paraffinato.

Cod.	ø mm	Metri	UM	€
3100525	0,5	80	PZ	
3101023	1,0	30	PZ	
3101523	1,5	20	PZ	

**Filo per Impiombature in Poliestere Paraffinato Colorato**

Filo per impiombature in Poliestere paraffinato colorato.

Cod.	Colore	ø mm	Metri	UM	€
3101122	BLU	1,5	20	PZ	
3101222	NERO	1,5	20	PZ	

**Filo per Impiombature in Dyneema**

Filo grigio Carbonio per impiombature in Dyneema paraffinato.

Cod.	ø mm	Metri	UM	€
3101025	1,2	30	PZ	



**Redance in Plastica**

Redance in Nylon Bianco evitano che cime o cavi si logorino per l'attrito.



Cod.	Per cima ø mm	UM	€
5430004	4	PZ	
5430005	5	PZ	
5430006	6	PZ	
5430008	8	PZ	
5430010	10	PZ	
5430012	12	PZ	
5430014	14	PZ	
5430016	16	PZ	
5430018	18	PZ	
5430020	20	PZ	
5430022	22	PZ	
5430024	24	PZ	

**Redance in Acciaio Inox**

Redance in Acciaio Inox AISI 316. Impediscono che cime o cavi si logorino per l'attrito.



Cod.	Per cima ø mm	UM	€
5425001	2	PZ	
5425002	2,5	PZ	
5425003	3	PZ	
5425004	4	PZ	
5425005	5	PZ	
5425006	6	PZ	
5425008	8	PZ	
5425010	10	PZ	
5425012	12	PZ	
5425014	14	PZ	
5425016	16	PZ	
5425018	18	PZ	
5425020	20	PZ	
5425022	22	PZ	
5425024	24/26	PZ	
5425028	28/30	PZ	
5425032	32/34	PZ	
5425036	36/38	PZ	
5425040	40/42	PZ	

**Manicotti in Alluminio per Impiombare**

Manicotti ovali in Alluminio Anodizzato per impiombare.



Cod.	Per cima ø mm	UM	€
5424503	3	PZ	
5424504	4	PZ	
5424505	5	PZ	
5424506	6	PZ	
5424508	8	PZ	
5424510	10	PZ	
5424512	12	PZ	
5424514	14	PZ	

**Manicotti in Rame per Impiombare**

Manicotti ovali in Rame per impiombare.



Cod.	Per cavo ø mm	UM	€
5424002	2	PZ	
5424003	3	PZ	
5424004	4	PZ	
5424005	5	PZ	
5424006	6	PZ	
5424008	8	PZ	

**Capicorda Termici**

Capicorda termorestringenti e antisfilciamento. Confezione da 6 pz.



Cod.	Cima ø mm	Confezione	UM	€
3191012	6,5<>12,5	6 Pz	CF	
3191018	10<>19	6 Pz	CF	

**- RIPARAZIONI VELE -****Scucitori per Vele**

Scucitori per vele sacche e tessuti.



Cod.	Lunghezza mm	UM	€
3191071	85	PZ	
3191072	130	PZ	

**Forbici Tagliafilì**

Forbici tagliafilì.



Cod.	Lunghezza mm	UM	€
3191080	110	PZ	

**Filo per Cuciture in Poliestere**

Filo per cuciture bianco in Poliestere.



Cod.	ø mm	Metri	UM	€
3100350	0,3	140	PZ	

**Kit Riparazione Vele Sail Set**

Scatola stagna con:

- 5 Aghi
- 1 Guardiapalmo
- 50 m Filo paraffinato da 1 mm
- 1 Rotolo adesivo per riparazioni veloci.



Cod.	UM	€
3191005	CF	

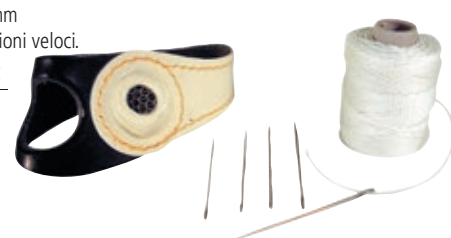



**Aghi Riparazione Vele**

Aghi per riparazioni di vele, tendalini e coperture.

Cod.	Ago 1 L mm	Ago 2 L mm	Ago 3 L mm	Ago 4 L mm	Ago 5 L mm	Ago 6 L mm	UM	€
3191050	40 (Curvo)	50 (Curvo)	75 (Curvo)				CF	
3191052	40 (Dritto)	50 (Dritto)	60 (Dritto)	100 (Dritto)	75 (Curvo)		CF	
3191054	40 (Dritto)	75 (Dritto)	125 (Dritto)	150 (Dritto)	200 (Dritto)	75 (Curvo)	CF	

**Nastro Ripstop Tape Spinnaker**

Nastro leggerissimo e tenace Ripstop Tape Spinnaker ideale per riparazioni immediate di vele leggere e spi.

Cod.	L m	H mm	Colore	UM	€
5720407	4.5	50	ROSSO	PZ	
5720408	4.5	50	BIANCO	PZ	
5720409	4.5	50	VERDE	PZ	
5720410	4.5	50	NERO	PZ	
5720411	4.5	50	GIALLO	PZ	
5720412	4.5	50	BLU	PZ	
5720413	4.5	50	BLU CHIARO	PZ	
5720414	4.5	50	ARANCIO	PZ	
5720415	4.5	50	PINK	PZ	
5720417	4.5	50	ARANCIO fluo	PZ	
5720418	4.5	50	VERDE fluo	PZ	
5720419	4.5	50	GIALLO fluo	PZ	

**Nastro Maintape Sail**

Nastro robustissimo e tenace Maintape per riparazioni immediate di vele di tutti i tipi.

Cod.	L m	H mm	Colore	UM	€
5720430	1.5	100	BIANCO	PZ	
5720431	1.5	100	BLUE	PZ	
5720432	1.5	100	ROSSO	PZ	

**Nastro Mylar Tape**

Nastro Mylar Tape per riparare le parti trasparenti di vele e capottine.

Cod.	L m	H mm	UM	€
5720440	3	50	PZ	
5720441	3	100	PZ	

**Nastro Kevlar Tape**

Nastro Kevlar Tape specifico per riparare vele in Kevlar.

Cod.	L m	H mm	UM	€
5720445	1.5	50	PZ	

**- SERRAVELE -****Elastici Millepiedi**

Elastici millepiedi usati per fissare la randa sul boma.

Cod.	L cm	ø mm	UM	€
3176020	200	8	PZ	
3176030	300	8	PZ	
3176130	300	10	PZ	

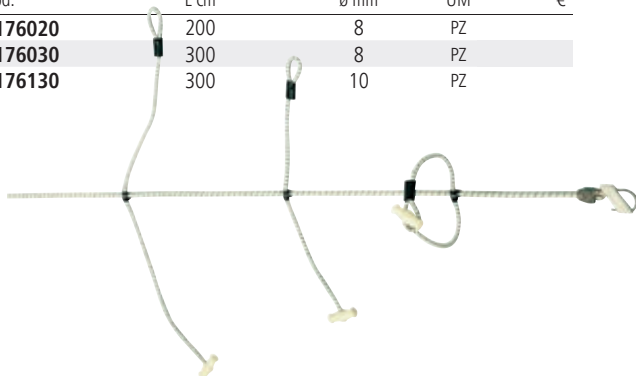
**Serravele Navishell**

Serravele in tessuto acrilico intrecciato. Idrorepellente e resistente ai raggi UV. Contiene un elastico al loro interno per facilitare l'applicazione. La confezione contiene 3 pezzi.

Cod.	ø Vela cm	UM	€
3175925	23<->33	CF	
3175926	27<->47	CF	
3175927	37<->58	CF	



**Corda Elastica Bianca**

Corda elastica Bianca di ottima qualità e durata.

Cod.	ø mm	m	UM	€
3170003100	3	100	MT	
3170004100	4	100	MT	
3170005100	5	100	MT	
3170006100	6	100	MT	
3170008100	8	100	MT	
3170010100	10	100	MT	
3170012100	12	100	MT	

**Corda Elastica Nera**

Corda elastica Nera di ottima qualità e durata.

Cod.	ø mm	m	UM	€
3170104100	4	100	MT	
3170105100	5	100	MT	
3170106100	6	100	MT	
3170108100	8	100	MT	
3170110100	10	100	MT	

**Corda Elastica Blu**

Corda elastica Blu Elettrico di ottima qualità e durata.

Cod.	ø mm	m	UM	€
3170404100	4	100	MT	
3170405100	5	100	MT	
3170406100	6	100	MT	
3170408100	8	100	MT	
3170410100	10	100	MT	



New

**Gancetti Classici Bianchi per Elastici**

Gancetto per elastici.

Cod.	Elastico ø mm	UM	€
0332804	4	PZ	
0332805	5*	PZ	
0332806	6	PZ	
0332808	8	PZ	
0332810	10	PZ	

**Gancetti Classici Neri per Elastici**

Gancetto per elastici.

Cod.	Elastico ø mm	UM	€
0332704	4	PZ	
0332705	5*	PZ	
0332706	6	PZ	
0332708	8	PZ	
0332710	10	PZ	

**Gancetti Inox per Elastici**

Gancetto in Acciaio Inox per elastici.

Cod.	Elastico ø mm	UM	€
0332816	6	PZ	
0332818	8	PZ	
0332820	10	PZ	

**Anelle Ferma Elastici**

Anelle ferma corda elastica. Confezione 100 pz.

Cod.	Elastico ø mm	UM	€
3175004	4	PZ	
3175006	5<>6	PZ	
3175008	8	PZ	
3175010	10	PZ	

**Gancetti Autobloccanti Bianchi per Elastici**

Gancetto autobloccante per elastici.

Cod.	Elastico ø mm	UM	€
0332843	5<>6	PZ	
0332844	8	PZ	

**Gancetti Autobloccanti Neri per Elastici**

Gancetto autobloccante per elastici.

Cod.	Elastico ø mm	UM	€
0332840	5<>6	PZ	
0332842	8	PZ	

**Gancetti Autoblock per Elastici**

Sistema autobloccante per elastici.

Cod.	Colore	Elastico ø mm	UM	€
0332835	BLU	5<>6	PZ	
0332836	NERO	5<>6	PZ	

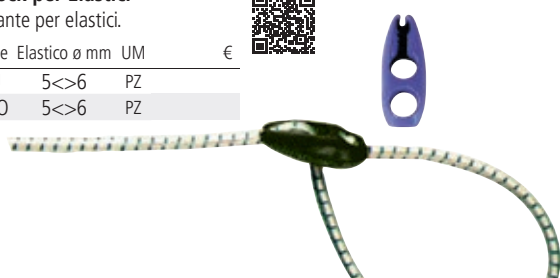
**Ganci Piatti per Elastici**

Gancetti fissa-telo per gommoni. In confezione da 10 pezzi.

Cod.	Colore	Elastico ø mm	UM	€
0332600	NERO	6/8	PZ	
0332610	BIANCO	6/8	PZ	
0332620	GRIGIO	6/8	PZ	



**Elastici con 2 Ganci Classic**

Elastici con 2 ganci classici in Nylon.

Cod.	L cm	ø mm	Confezione pz	UM	€
3172420	20	4	4	PZ	
3172430	30	4	4	PZ	
3172630	30	6	4	PZ	
3172650	50	6	4	PZ	
3172850	50	8	2	PZ	
3173010	100	10	2	PZ	

**Elastici con 2 Ganci Open**

Elastici con 2 ganci aperti in Nylon.



Cod.	L cm	ø mm	Confezione pz	UM	€
3172404	20	4	4	PZ	
3172405	30	4	4	PZ	
3172406	30	6	4	PZ	
3172407	50	6	4	PZ	



New

**Elastici con 1 Gancio Open**

Elastici con 1 gancio aperto in Nylon.

Cod.	L cm	ø mm	Confezione pz	UM	€
3174520	20	4	4	PZ	
3174535	35	4	4	PZ	
3174555	55	4	4	PZ	
3174563 	35	6	4	PZ	
3174565 	55	6	4	PZ	
3174567 	75	6	4	PZ	

**Elastici con Autobloccante**

Elastici con sistema autobloccante.

Cod.	L cm	ø mm	Confezione pz	UM	€
3175550	50	5	4	PZ	
3175670	70	6	4	PZ	

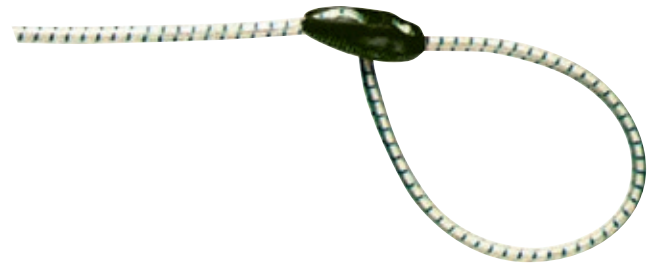
**Elastici con Caviglia**

Elastici con caviglia.

Cod.	L cm	ø mm	Confezione pz	UM	€
3175935	35	6	4	PZ	
3175955	55	6	4	PZ	
3175975	75	6	4	PZ	

**Elastici con Palline**

Elastici con palline fissavele e usi vari.

Cod.	L cm	ø mm	Confezione pz	UM	€
3175830	30	4	4	PZ	
3175840	40	4	4	PZ	
3175850	50	4	4	PZ	

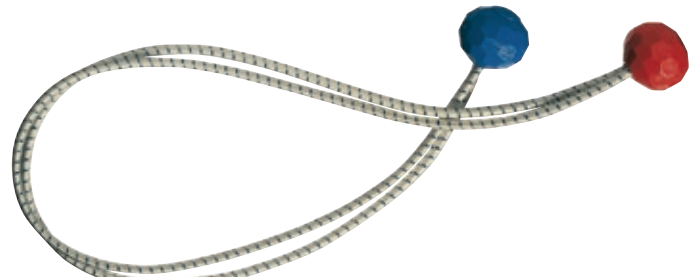
**Elastici con 2 Ganci Inox**

Elastici con 2 ganci Inox.

Cod.	L cm	ø mm	Confezione pz	UM	€
3173630	30	6	2	PZ	
3173850	50	8	2	PZ	
3173880	80	8	2	PZ	
3174075	80	10	2	PZ	
3174110	100	10	2	PZ	

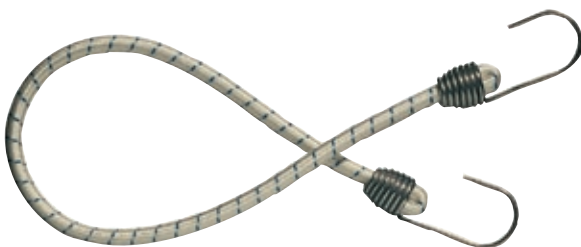
**Elastici con 2 Ganci Black Inox**

Elastici con 2 ganci in Acciaio Inox verniciato nero e tappo terminale di protezione in gomma.

Cod.	L cm	ø mm	Confezione pz	UM	€
3173663	30	6	2	PZ	
3173665	50	6	2	PZ	
3173685	50	8	2	PZ	
3173688	80	8	2	PZ	



New



**Cinghie Blue**

Cinghie in Polipropilene Blue per uso nautico. Vendute a rotolo.

Cod.	H mm	Lunghezza m	UM	€
315000150	25	50	MT	
315000250	30	50	MT	
315000350	40	50	MT	

**Cinghie Nere**

Cinghie in Polipropilene Nero per uso nautico. Vendute a rotolo.

Cod.	H mm	Lunghezza m	UM	€
315010150	25	50	MT	
315010250	30	50	MT	
315010350	40	50	MT	

**Cinghie Bianche**

Cinghie in Polipropilene Bianco per uso nautico. Vendute a rotolo.

Cod.	H mm	Lunghezza m	UM	€
315020150	25	50	MT	
315020250	30	50	MT	
315020350	40	50	MT	

**Cinghie Rosse**

Cinghie in Polipropilene Rosso per uso nautico. Vendute a rotolo.

Cod.	H mm	Lunghezza m	UM	€
315030150	25	50	MT	
315030250	30	50	MT	
315030350	40	50	MT	

**Cinghia Liros Dyneema Webbing**

Cinghia multiuso in Dyneema SK78 con carico di rottura altissimo. Allungamento minimo, molto resistente alle abrasioni, non assorbe acqua e resiste ai raggi UV.

Cod.	H mm	Lunghezza m	Carico di rottura Kg	UM	€
315102550	25	50	1800	MT	

**Fibbia Entrata Doppia per Cinghie**

Fibbie a entrata doppia in Acciaio Inox per cinghie.

Cod.	Dim mm	Entrata mm	UM	€
3180101	62 x 34	50	PZ	
3180102	35 x 25	26	PZ	

**Cinghia di Ancoraggio Cargo Inox**

Cinghia di ancoraggio con fibbia in Acciaio Inox e nastro in Poliestere ad alta tenacità. Ideale per il fissaggio di carichi leggeri fino a 250 Kg su imbarcazioni, ponti, stive, carrelli e automezzi. Certificata CE EN12195/2.

Cod.	H mm	L m	Carico di Rottura Kg	UM	€
3180026	25	2,5	250	PZ	
3180041	25	4	250	PZ	



**Cinghia Tensionatrice Standard**

Cinghia tensionatrice con cricchetto in Acciaio Cadmiato e nastro in Poliestere ad alta tenacità. Ideale per il fissaggio di qualsiasi carico su imbarcazioni, ponti, stive, carrelli e automezzi. Certificata CE EN12195/2.

Cod.	H mm	L m	Carico di Rottura Kg	UM	€
3180400	25	3	1500	PZ	
3180401	25	6	1500	PZ	
3180404	35	6	2000	PZ	
3180408	50	8,5	5000	PZ	

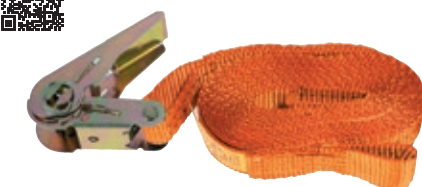

H 25mm

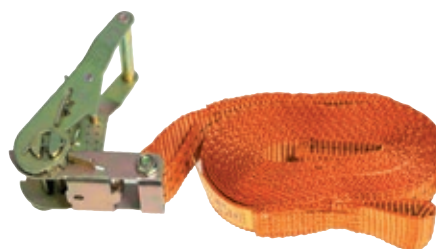

H 35mm

**Cinghia Tensionatrice Standard con Gancio**

Cinghia tensionatrice con cricchetto e ganci in Acciaio Cadmiato e nastro in Poliestere ad alta tenacità. Ideale per il fissaggio di qualsiasi carico su imbarcazioni, ponti, stive, carrelli e automezzi. Certificata CE EN12195/2.

Cod.	H mm	L m	Carico di Rottura Kg	UM	€
3180402	25	6	400	PZ	
3180403	35	6	1000	PZ	
3180406	50	8,5	2500	PZ	



H 25mm

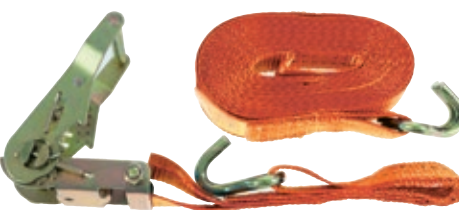

H 35mm

**Cinghia Tensionatrice Inox**

Cinghia tensionatrice con cricchetto in Acciaio Inox e nastro in Poliestere ad alta tenacità. Ideale per il fissaggio di qualsiasi carico su imbarcazioni, ponti, stive, carrelli e automezzi. Certificata CE EN12195/2.

Cod.	H mm	L m	Carico di Rottura Kg	UM	€
3180425	25	6	600	PZ	
3180435	35	6	900	PZ	



H 25mm



H 35mm

**Cinghia Tensionatrice Inox con Gancio**

Cinghia tensionatrice con cricchetto e ganci in Acciaio Inox e nastro in Poliestere ad alta tenacità. Ideale per il fissaggio di qualsiasi carico su imbarcazioni, ponti, stive, carrelli e automezzi. Certificata CE EN12195/2.

Cod.	H mm	L m	Carico di Rottura Kg	UM	€
3180462	25	6	400	PZ	
3180464	35	6	750	PZ	



H 25mm



H 35mm



**Copertura Nautica Termoretraibile**

Film in polietilene termoretraibile bianco resistente ai raggi UV, ideale per la copertura di qualsiasi tipo d'imbarcazione durante il rimessaggio o il trasporto. Protegge da sporco, piccoli urti e sbalzi di temperatura. Applicazione semplice mediante l'apposita termopistola. Spessore telo 0.200mm.

Cod.	W m	L m	H rotolo m	Peso kg	Piegatura	UM	€
5791008	8	50	1	77,7	Multipiegato	PZ	
5791010	10	50	1,25	97,1	Multipiegato	PZ	



New



**Copertura Nautica Indoor**

Film trasparente, sottile ed elastico che aderisce perfettamente al trinciato. Resistente e leggero, ideale per proteggere l'imbarcazioni da sporco e polvere nei rimessaggi. Spessore telo 0.040mm.

Cod.	W m	L m	H rotolo m	Peso kg	Piegatura	UM	€
5791028	8	50	1	15,5	Multipiegato	PZ	
5791030	10	50	1,25	19	Multipiegato	PZ	



New



**Termopistola Shrink a Gas Propano**

Termopistola a gas propano per la termoretrazione dei teli di copertura in polietilene. Robusta, leggera e maneggevole, pesa solo 1 kg. Bassi consumi e grande resa con una potenza continua di 32 kW/h effettivi. Accensione piezo con dispositivo di sicurezza integrato, una volta rilasciato il grilletto si spegne automaticamente. Completa di regolatore di pressione e 8m di tubo in gomma. Certificato CE EN 746 Standard, 1 anno di garanzia.



Cod.	UM	€
5791053	PZ	



**Termopistola Hornet a Gas Propano**

Termopistola a gas propano di ultima generazione per la termoretrazione dei teli di copertura in polietilene. Robusta ed estremamente leggera, pesa solo 500 g. Dotata di due bruciatori (da 30 e 70 kW/h), ultra efficace grazie alla tecnologia della fiamma mirata che mantiene i bruciatori a temperatura moderata. Accensione piezo sincronizzata a bassa portata e impugnatura di sicurezza, una volta rilasciato il grilletto si spegne automaticamente. Completa di tubo in gomma di qualità professionale ISO 3821 con semplice connessione alla pistola grazie al raccordo rapido. Disponibile la prolunga da 1,25 m, leggera e potente (<90 kW/h) per raggiungere superfici più alte e ampie anche con una sola mano. Certificato CE1312, 2 anno di garanzia.



Cod.	Ref	Accessori	UM	€
5791047	Termopistola Hornet		PZ	
5791041		Prolunga 1,25m	PZ	



VELA FERRAMENTA/CORDAME COPERTURE/BANDIERE RIVESTIMENTI

**Porte e Aperture per Teli Copertura**

Aperture in polietilene che permettono l'accesso alla barca coperta da telo termoretraibile. Si collega tramite nastro adesivo apposto.

Cod.	Dim mm	UM	€
5791060	1750 x 750	PZ	
5791063	700 x 300	PZ	



New



**Nastro Adesivo Termoretraibile**

Nastro adesivo in Polietilene bianco per lavori di termoretrazione con film termoretraibile per esterni. Resistente all'abrasione, ai raggi UV e agli agenti atmosferici, sigilla ermeticamente i bordi del film termoretraibile per il trasporto o lo stoccaggio delle imbarcazioni prolungato all'aperto. Usato anche per l'installazione di porte, aperture e prese d'aria.

Cod.	Larghezza mm	Lunghezza m	UM	€
5791071	50	33	PZ	
5791070	96	55	PZ	



New



**Nastro Adesivo per Teli di Copertura Nautica**

Nastro adesivo in Polietilene bianco per teli di copertura nautica. Sigilla i bordi del film per il trasporto o lo stoccaggio delle imbarcazioni. Usato anche per l'installazione di porte, aperture e prese d'aria.

Cod.	Larghezza mm	Lunghezza m	UM	€
5791072	50	50	PZ	



New



**Treppiede Distanziatore per Teli Copertura**

Distanziatore che serve per separare il film termoretraibile dall'imbarcazione che sta coprendo. Combinato con reggette o nastro adesivo fornisce una protezione semplice ed efficace. La circolazione dell'aria è estremamente importante, in particolare su scafi verniciati dove, in queste applicazioni, il film termoretraibile può entrare in contatto con la vernice e causare bolle d'aria provocando danni durante lo stoccaggio o il trasporto.

Cod.	Dim mm	UM	€
5791088	80 x 80 x H70	PZ	



New



**Prese d'Aria per Coperture Termoretraibili**

Prese d'aria facili da installare semplicemente perforando il film termoretraibile e chiudendo con il nastro apposito. Proteggono da condensa, muffe e odori, evitando che pioggia e neve penetrino sotto la copertura. La presa d'aria rotonda è dotata di adesivo.

Cod.	Ref	Dim mm	UM	€
5791080	Presse d'aria triangolare perforante	180 x 80 x H35	PZ	
5791081	Presse d'aria rotonda adesiva	ø 105 x H30	PZ	



New



**Presse d'Aria Clip**

Presse d'aria a clip di facile installazione tramite perforazione o anello autoadesivo. Una volta installata sulla pellicola, rinnova continuamente l'aria all'interno di una barca o di una stanza umida.

Cod.	Dim mm	UM	€
5791085	110 x H50	PZ	



New



**Taglierini per Copertura Nautica**

Taglierini professionali, antiscivolo, ergonomici e facili da usare. Per teli di copertura nautica, nastri adesivi, reggette e altro.

Cod.	Ref	Peso	UM	€
5791068	Security	20 g	PZ	
5791069	Max	18 g	PZ	



New



**Tasca Porta Manovella AA**

Tasca porta manovella in morbido PVC resistente raggi UV con foro drenante.

Cod.	Dim cm	UM	€
3840035	9 x 6 x H28,5	PZ	



**Tasca Manovella Winch Navishell**

Tasca per manovella winch in tessuto acrilico idrorepellente e resistente ai raggi UV. I colori indelebili stabilizzati restano vivaci per almeno 3 anni di utilizzo continuo. Le ventose garantiscono un facile e sicuro fissaggio alle pareti. Due i sistemi di fissaggio a scelta in dotazione:  
1) Con ventose che garantiscono un facile e sicuro fissaggio senza fori a parete.  
2) Con gancetti che garantiscono un facile e sicuro fissaggio forando la parete.

Cod.	Dim cm	Colore	UM	€
3215619	25 x 12 x 8	BLU NAVY	PZ	
3215620	25 x 12 x 8	GRIGIO	PZ	



**CopriWinch Navishell**

Copriwinch in tessuto acrilico idrorepellente e resistente ai raggi UV. I colori indelebili stabilizzati restano vivaci per almeno 3 anni di utilizzo continuo.

Cod.	Colore	Per winch H x ø cm	UM	€
3215622	BLU NAVY	25 x 17	PZ	
3215625	BLU NAVY	27 x 18,7	PZ	
3215628	BLU NAVY	29 x 21,3	PZ	
3215623	GRIGIO	25 x 17	PZ	
3215626	GRIGIO	27 x 18,7	PZ	
3215627	GRIGIO	29 x 21,3	PZ	



**CopriWinch Fendress Soft**

Cappucci copriwinch di qualità superiore in tessuto acrilico felpato e sofficie. Resistenti ai raggi UV e all'acqua di mare, mantengono inalterate le caratteristiche e i colori. Proteggono il winch facendolo respirare senza creare condensa. Si lavano in lavatrice e si asciugano subito. In confezioni da 2 pezzi.

Cod.	Colore	Taglia	Per winch H x ø cm	UM	€
3215559	BLU NAVY	Small	16 x 14	PZ	
3215560	BLU NAVY	Medium	18 x 17	PZ	
3215561	BLU NAVY	Large	22 x 18	PZ	
3215559WN	ROSSO VINO	Small	16 x 14	PZ	
3215560WN	ROSSO VINO	Medium	18 x 17	PZ	
3215561WN	ROSSO VINO	Large	22 x 18	PZ	
3215559BR	BLU ROYAL	Small	16 x 14	PZ	
3215560BR	BLU ROYAL	Medium	18 x 17	PZ	
3215561BR	BLU ROYAL	Large	22 x 18	PZ	
3215559BK	NERO	Small	16 x 14	PZ	
3215560BK	NERO	Medium	18 x 17	PZ	
3215561BK	NERO	Large	22 x 18	PZ	
3215559SA	SABBIA	Small	16 x 14	PZ	
3215560SA	SABBIA	Medium	18 x 17	PZ	
3215561SA	SABBIA	Large	22 x 18	PZ	
3215559SG	GRIGIO CHIARO	Small	16 x 14	PZ	
3215560SG	GRIGIO CHIARO	Medium	18 x 17	PZ	
3215561SG	GRIGIO CHIARO	Large	22 x 18	PZ	



VELA FERRAMENTA/CORDAME COPERTURE/BANDIERE RIVESTIMENTI



**Coprimotore Fendboard**

Copri motore fuoribordo di qualità superiore, fatti con lo stesso tessuto morbido e robustissimo usato per i copriparabordi Fendress. Proteggono da usura, sfregamenti, colpi, intemperie, acqua di mare, raggi UV e si possono lasciare sul motore anche in navigazione. Costruiti in tessuto traspirante, non creano condensa, non scoloriscono, si lavano in lavatrice e si asciugano subito. Il vostro fuoribordo resterà a lungo come nuovo grazie a Fendboard.

Cod.	Colore	Dimensioni cm	Taglia	Per motore HP	UM	€
3270801	BLUE NAVY	36x20x20	S	2<>5	PZ	
3270802	BLUE NAVY	40x20x25	M	9.9<>15	PZ	
3270803	BLUE NAVY	60x35x35	L	25<>150	PZ	
3270804	BLUE NAVY	60x50x50	XL	200>	PZ	
3270801WN	ROSSO VINO	36x20x20	S	2<>5	PZ	
3270802WN	ROSSO VINO	40x20x25	M	9.9<>15	PZ	
3270803WN	ROSSO VINO	60x35x35	L	25<>150	PZ	
3270804WN	ROSSO VINO	60x50x50	XL	200>	PZ	
3270801BR	BLUE ROYAL	36x20x20	S	2<>5	PZ	
3270802BR	BLUE ROYAL	40x20x25	M	9.9<>15	PZ	
3270803BR	BLUE ROYAL	60x35x35	L	25<>150	PZ	
3270804BR	BLUE ROYAL	60x50x50	XL	200>	PZ	
3270801BK	NERO	36x20x20	S	2<>5	PZ	
3270802BK	NERO	40x20x25	M	9.9<>15	PZ	
3270803BK	NERO	60x35x35	L	25<>150	PZ	
3270804BK	NERO	60x50x50	XL	200>	PZ	
3270801SA	SABBIA	36x20x20	S	2<>5	PZ	
3270802SA	SABBIA	40x20x25	M	9.9<>15	PZ	
3270803SA	SABBIA	60x35x35	L	25<>150	PZ	
3270804SA	SABBIA	60x50x50	XL	200>	PZ	
3270801SG	GRIGIO CHIARO	36x20x20	S	2<>5	PZ	
3270802SG	GRIGIO CHIARO	40x20x25	M	9.9<>15	PZ	
3270803SG	GRIGIO CHIARO	60x35x35	L	25<>150	PZ	
3270804SG	GRIGIO CHIARO	60x50x50	XL	200>	PZ	

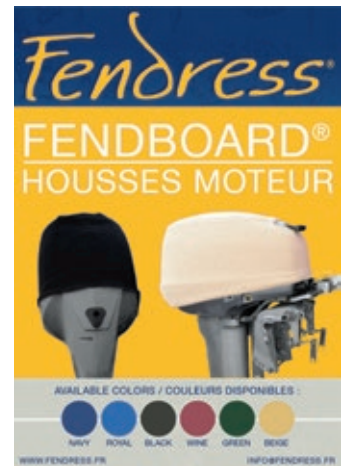
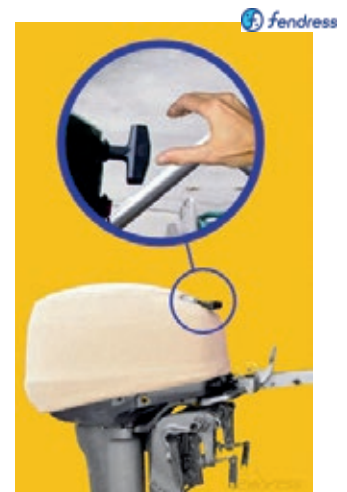

**Teli Copri Testa Motore Silver Shield**

Teli copri testa motore di ottima qualità in resistente Poliestere 420D con spalmatura in PA per una impermeabilità perfetta. Resistenti UV grazie al colore argento che riflette i raggi solari. Dotati di elastico interno per aderire perfettamente a qualsiasi tipo di motore.

Cod.	L cm	W cm	H cm	Taglia	UM	€
3270105	40	25	30	XXS	PZ	
3270106	48	27	33	XS	PZ	
3270107	55	33	42	S	PZ	
3270108	63	35	48	M	PZ	
3270109	73	40	65	L	PZ	
3270110	75	45	75	XL	PZ	
3270111	90	60	80	XXL	PZ	

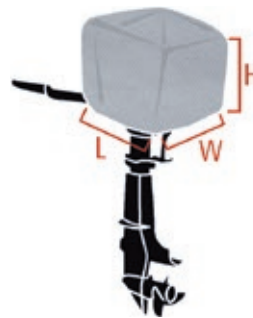

**Teli Copri Motore Silver Shield**

Teli coprimotore di ottima qualità in resistente Poliestere 420D con spalmatura in PA per una impermeabilità perfetta. Resistenti UV grazie al colore argento che riflette i raggi solari.

Cod.	L cm	W cm	H cm	A cm	Taglia	UM	€
3270101	25	25	110	25	S	PZ	
3270102	50	30	135	70	M	PZ	
3270103	125	45	210	110	L	PZ	

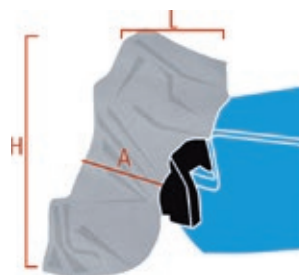

**Teli Copri Barca Silver Shield**

Teli copri barca di ottima qualità in resistente Poliestere con spalmatura in PA per una impermeabilità perfetta. Resistenti UV, riflettono i raggi solari grazie al colore argento (tranne misure XL-XXL-XXXL di colore blu). Dotati di elastico interno per aderire perfettamente a qualsiasi tipo di imbarcazione e di doppie cuciture per la migliore durata nel tempo. Gli anelli a D antigraffio e la cima in dotazione assicurano un'ulteriore fissaggio di sicurezza.



Cod.	Barca L cm	Larghezza max barca cm	Tessuto	Taglia	UM	€
3270000	240<->300	150	Poliestere 300D	TENDER	PZ	
3270001	300<->360	150	Poliestere 300D	TENDER	PZ	
3270002	427<->488	180	Poliestere 300D	XXS	PZ	
3270003	427<->488	229	Poliestere 300D	XS	PZ	
3270004	488<->564	239	Poliestere 300D	S	PZ	
3270005	518<->579	244	Poliestere 300D	M	PZ	
3270006	550<->610	265	Poliestere 300D	L	PZ	
3270007	580<->650	295	Poliestere 300D	XL	PZ	
3270008	630<->710	380	Poliestere 600D	XXL	PZ	
3270009	700<->780	400	Poliestere 600D	XXXL	PZ	

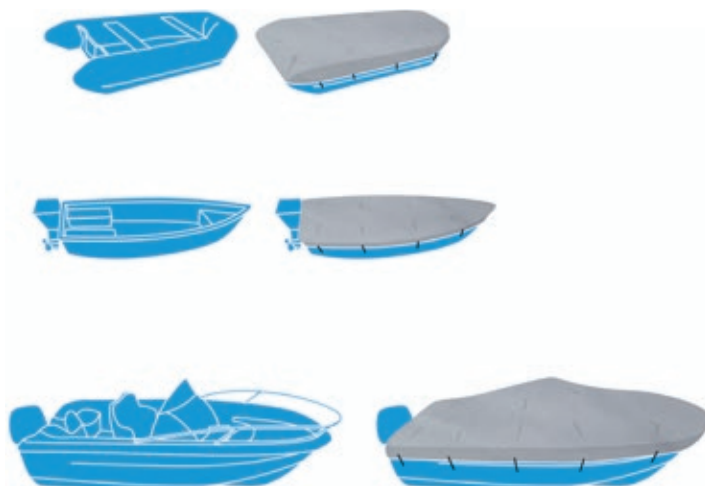

**Teli Copri Consolle Silver Shield**

Teli copri consolle di ottima qualità in resistente Poliestere 420D con spalmatura in PA per una impermeabilità perfetta. Resistenti UV grazie al colore argento che riflette i raggi solari. Dotati di elastico interno per aderire perfettamente a qualsiasi tipo di consolle.



Cod.	A cm	B cm	C cm	D cm	Taglia	UM	€
3270201	115	90	45	55	XS	PZ	
3270202	90	65	75	85	S	PZ	
3270203	120	105	70	65	M	PZ	
3270204	140	100	90	70	L	PZ	
3270205	140	100	90	90	XL	PZ	

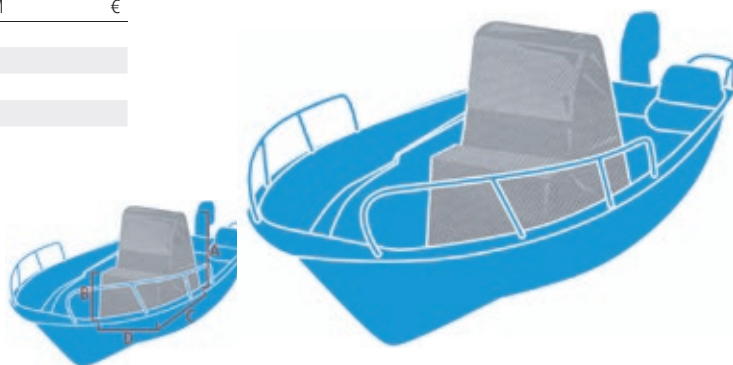
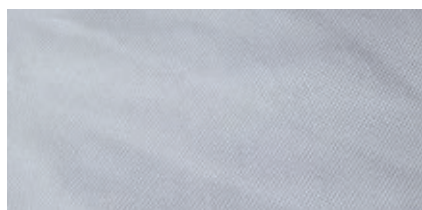

**Telo Copri Sedile Silver Shield**

Telo copri sedile universale di ottima qualità in resistente Poliestere 420D con spalmatura in PA per una impermeabilità perfetta. Resistente UV grazie al colore argento che riflette i raggi solari. Dotato di elastico interno per aderire perfettamente a qualsiasi tipo di sedile o poltroncina.



Cod.	UM	€
3270210	PZ	



8 VELA FERRAMENTA/CORDAME COPERTURE/BANDIERE RIVESTIMENTI

**Asta di Sostegno Componibile per Teli**

Asta componibile in ABS rinforzato per il sostegno di teli copertura imbarcazioni.

Cod.	H cm	UM	€
3269710	30<>140	PZ	

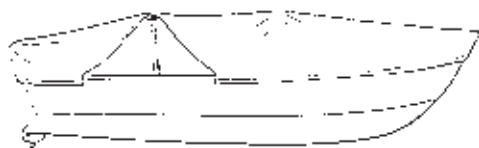

**Aste di Sostegno Telescopica per Teli**

Aste telescopiche per il sostegno di teli copertura imbarcazioni.

Cod.	H cm	UM	€
3269701	58<>102	PZ	
3269702	86<>150	PZ	
3269703	108<>200	PZ	



**Arco Dock Edge per Sostegno Teli**

Arco flessibile componibile in Vetrosina rinforzata per il sostegno di teli di copertura di imbarcazioni. Composto da due aste lamellari che si fissano tra loro alla lunghezza desiderata.

Cod.	L cm	L max cm	UM	€
3269718	2 x 91	183	PZ	
3269724	2 x 122	244	PZ	



DOCK EDGE 

**Sistema Fermateloni Hold-on Grip**

Sistema fermateloni Hold-on Grip in Nylon in confezioni da 10 pezzi. Si compone di 2 parti di cui una lavora da cuneo: più tira il tessuto, più tiene.

Cod.	Dim mm	Spessore telo mm	UM	€
3214303	40 x 35 x 10	0<>2	PZ	
3214305	73 x 38 x 18	1,5<>5	PZ	

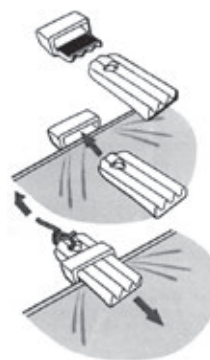

**Sistema Fermateloni Kraken Grip**

Sistema fermateloni Kraken Grip a ventosa con elastico. Non occorre forare lo scafo. Confezione 6 pz.

Cod.	ø mm	L elastico mm	UM	€
3214800	90	200	PZ	

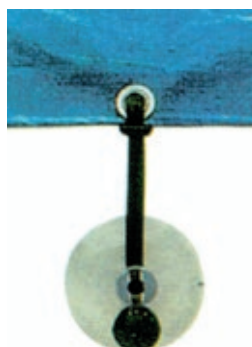

**Chiusure Lampo (Zip)**

Chiusure lampo per uso marino con cursore e terminali. Larghezza 42 mm.



Cod.	cm	UM	€
3216010	100	PZ	
3216015	150	PZ	
3216020	200	PZ	
3216025	250	PZ	
3216030	300	PZ	

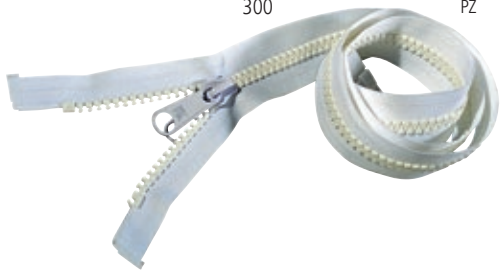

**Chiusura Lampo (Zip) a Metro**

Chiusura lampo a nastro continuo da tagliare a misura. Larghezza 42 mm. Cursore venduto a parte.



Cod.	Ref	UM	€
3216001	Bobina da 100 m	MT	
3216002	Cursore	PZ	



**Nastri Velcro**

Nastri Velcro per fissare tessuti e rivestimenti. Maschio + femmina.



Cod.	W mm	L m	UM	€
3215000	25	25	MT	
3215001	40	25	MT	



**Dischetti Velcro**

Dischetti maschio+femmina Velcro per fissare tessuti e rivestimenti.



Cod.	ø mm	Pezzi	UM	€
3215005	25	10 Coppie	CF	
3215006	45	5 Coppie	CF	



**Strisce Adesive Velcro in Blister**

Strisce adesive Velcro maschio+femmina per fissare tessuti e rivestimenti.



Cod.	Dim mm	UM	€
3215015	20 x 350	CF	
3215016	20 x 700	CF	
3215017	20 x 1000	CF	

New



**Striscie Richiudibili 3M Dual Lock Blister**

Sistema di fissaggio autoadesivo richiudibile 3M Dual Lock con adesivo acrilico VHB. A differenza del velcro, resiste a migliaia di aperture con una tenuta superiore.



Ideale per fissaggi di oggetti grandi e piccoli, anche pesanti. Confezione blister da 2 strisce.

Cod.	Colore	Dim mm	UM	€
3215020	TRASPARENTE	25 x 76	CF	
3215021	NERO	25 x 76	CF	



**Nastro Richiudibile 3M Dual Lock Mini Pack**

Sistema di fissaggio autoadesivo richiudibile 3M Dual Lock con adesivo acrilico VHB. A differenza del velcro, resiste a migliaia di aperture con una tenuta superiore. Ideale per fissaggi di tende, tessuti, rivestimenti, chiusure, borse termiche, ecc.



Cod.	W mm	L m	UM	€
3215012	25	5	PZ	



**Nastro Velcro 3M Scotchmate Mini Pack**

Sistema di fissaggio autoadesivo richiudibile a velcro 3M Scotchmate con adesivo in gomma resina. Ideale per fissaggi di tende, tessuti, rivestimenti, chiusure, borse termiche, ecc.



Cod.	W mm	L m	UM	€
3215010	25	5	PZ	



VELA FERRAMENTA/CORDAME COPERTURE/BANDIERE RIVESTIMENTI

8

**Funghetti Ferma Telo**

Funghetti passacorda in Nylon per fissare i teloni. H senza base 11 mm, dia esterno 12 mm, dia collo 8,5 mm. Confezione da 100 pz.



Cod.	H mm	Foro ø mm	Colore	Pezzi	UM	€
<b>3211610</b>	13	2,8	NERO	100	PZ	
<b>3211613</b>	13	2,8	BIANCO	100	PZ	

**Sottoviti in Plastica**

Sottoviti in Plastica. Confezione 100 pz.



Cod.	Foro ø mm	Colore	Pezzi	UM	€
<b>3211804</b>	4,5	NERO	100	PZ	
<b>3211805</b>	5,5	NERO	100	PZ	
<b>3211904</b>	4,5	BIANCO	100	PZ	
<b>3211905</b>	5,5	BIANCO	100	PZ	

**Sottoviti in Plastica con Copritesta**

Sottoviti in Plastica con copritesta a pressione. Confezione 100 pz.



Cod.	Per viti ø mm	Pezzi	UM	€
<b>3211703</b>	3,5<4,2	100	PZ	
<b>3211705</b>	4,8<6,0	100	PZ	

**Confezione Occhielli in Plastica**

Confezione da 12 occhielli in Plastica. Si montano con un semplice colpo di martello. Diametro interno 15 mm / esterno 35 mm.



Cod.	Colore	Pz	UM	€
<b>3211514</b>	BLUE	12	CF	
<b>3211614</b>	BIANCO	12	CF	

**Occhielli in Ottone Cromato**

Occhielli in Ottone Cromato da montare con apposite pinze o torchietti.



Cod.	ø Interno mm	ø Esterno mm	Pezzi	UM	€
<b>3211108</b>	8	15	1000	PZ	
<b>3211110</b>	10	19	1000	PZ	
<b>3211112</b>	12	22	1000	PZ	
<b>3211115</b>	15	24	1000	PZ	

**Occhielli in Blister**

Confezioni di occhielli inossidabili completi di attrezzatura per il montaggio.

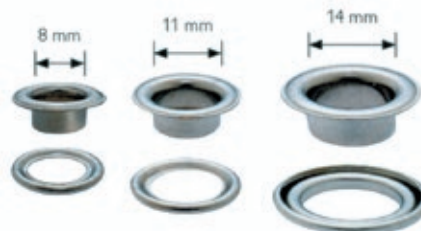

Cod.	Occhielli in blister	UM	€
<b>3211158</b>	24 Pezzi (8 mm)	CF	
<b>3211161</b>	15 Pezzi (11 mm)	CF	
<b>3211164</b>	10 Pezzi (14 mm)	CF	

**Bottoni a Pressione in Blister**

Confezione di bottoni a pressione inossidabili completi di viti e di attrezzatura per il montaggio. Diametro bottoni 15 mm e foro vite da 4 mm.



Cod.	Bottoni in blister	UM	€
<b>3210010</b>	10 Pezzi	CF	



**Set Valigetta Vario Plus**

Valigetta con pinza Vario completa di punzoni e un assortimento di 50 bottoni e occhielli per ogni esigenza.



Cod.	UM	€
3210214	PZ	

**Torchietto Pressa Bottone e Occhielli**

Torchio a mano per pressare bottoni e occhielli.



Cod.	UM	€
3210202	PZ	

**Kit Punzoni per Bottoni e Occhielli**

Kit punzoni per bottoni a pressione e occhielli.



Cod.	Ref	Ø mm	UM	€
3210205	Kit per bottoni a pressione		CF	
3210207	Kit occhielli OC	15	CF	
3210208	Kit occhielli OC	19	CF	
3210209	Kit occhielli OC	24	CF	
3210210	Kit occhielli OC	30	CF	
3210211	Kit occhielli OC	22	CF	

**Bottoni a Pressione in Ottone Cromato**

Bottoni a pressione in Ottone cromato. Diametro 15 mm. Testa: si pressa sulla sotto-testa con in mezzo il tessuto. Base: si fissa su legno, VTR e metalli. Sotto-base: si pressa alla base con in mezzo il tessuto per attaccare tessuto con tessuto.



Cod.	Ref	Pezzi / CF	UM	€
3210000	Testa	1000	PZ	
3210001	Sotto-testa	1000	PZ	
3210002	Base	1000	PZ	
3210003	Sotto-base	1000	PZ	

**Bottoni a Pressione in Acciaio Inox**

Bottoni a pressione in Acciaio Inox. Diametro 15 mm. Testa: si pressa su sotto-testa con in mezzo il tessuto. Base: si fissa su legno, VTR e metalli. Sotto-base: si pressa alla base con in mezzo il tessuto per attaccare tessuto con tessuto.



Cod.	Ref	Pezzi / CF	UM	€
3210500	Testa	1000	PZ	
3210501	Sotto-testa	1000	PZ	
3210502	Base	1000	PZ	
3210503	Sotto-base	1000	PZ	

**Pinza Pressa Bottoni Vario**

Pinza Vario per forare tessuti e montare bottoni a pressione ed occhielli. Non contiene punzoni.



Cod.	UM	€
3210204	PZ	



**Testa su Base**

Testa su base da fissare su legno, vetroresina o metallo. Diametro fori vite: 4 mm.

Cod.	Larghezza mm	UM	€
3211000	32	PZ	



**Testa per Tessuto**

Testa da fissare a tessuti di coperture. Permette un montaggio fai-da-te.

Cod.	UM	€
3211010	PZ	



**Occhiello Easy**

Occhiello Easy facile da montare fai-da-te.

Cod.	UM	€
3211001	PZ	



**Occhiello a Pressare**

Occhiello a pressare. Diametro foro 10 x 15 mm. Montaggio con torchietto.

Cod.	UM	€
3211003	PZ	



**Bottoni Girevoli in Blister**

Confezione di bottoni girevoli inossidabili completi di viti e attrezzo per il montaggio.

Cod.	Bottoni in blister	UM	€
3211044	4 Pezzi	CF	



**Fissa Teloni a Scatto Minax**

Fissa teloni automatico Minax composto da testa in plastica antiurto e vite in Acciaio Inox. La testa viene fissata sul telone e si blocca sulla vite con semplice sistema a scatto. La vite viene fissata sulla struttura e funge da punto di attacco.

Cod.	Ref	UM	€
3214250	Testa Minax	PZ	
3214256	Vite	PZ	



**Fissaggio Pannelli Fastmount STD**

Sistema di fissaggio pannelli Fastmount Standard range. Questo innovativo sistema garantisce un facile e sicuro fissaggio di qualsivoglia pannello. Tutti i componenti femmina sono compatibili con tutti i componenti maschio.

FASTMOUNT

Cod.	OEM	Ref	Accessori	UM	€
3320250	PC-F1A	Femmina autofilettante foro ø 16,8mm		PZ	
3320251	PC-SF1	Femmina montaggio a superficie		PZ	
3320252	PC-RF1	Femmina montaggio laterale		PZ	
3320260	PC-M1B	Maschio ad incasso autofilettante foro ø 10mm. Carico 10Kg		PZ	
3320261	PC-M2H	Maschio ad incasso autofilettante foro ø 10mm. Carico 10Kg		PZ	
3320262	PC-VM1	Maschio ad incasso autofilettante foro ø 10mm a profondità variabile. Carico 5Kg		PZ	
3320263	PC-SM2	Maschio da incollare. Carico 5Kg		PZ	
3320264	PC-SM2H	Maschio da incollare. Carico 10Kg		PZ	
3320291	CT-03		Punta per avvitare 3320250	PZ	
3320292	CT-07		Punta per foro ø 16,8mm	PZ	
3320293	CT-15		Punta per filettare foro ø 16,8mm	PZ	
3320294	CT-10		Punta per avvitare 3320260/61/62	PZ	
3320290	PC-01ST		Centratore per segnare foro maschi	PZ	

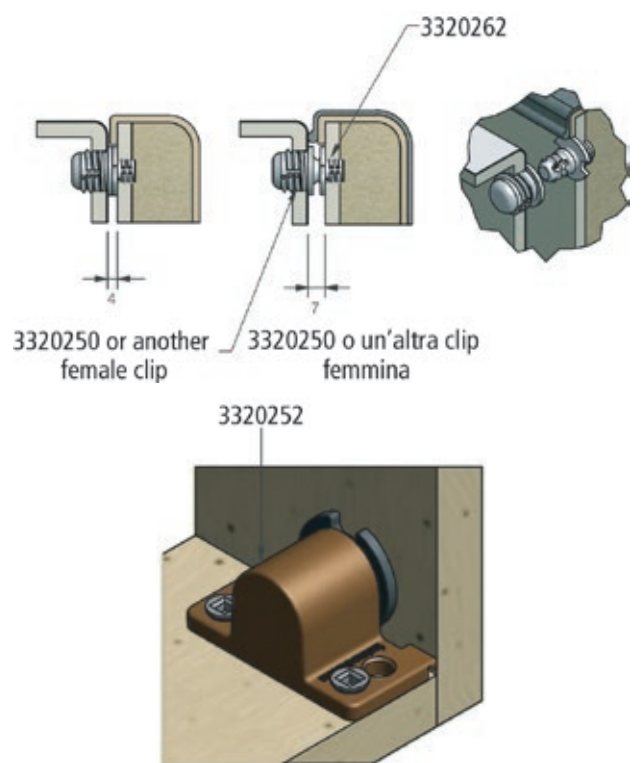
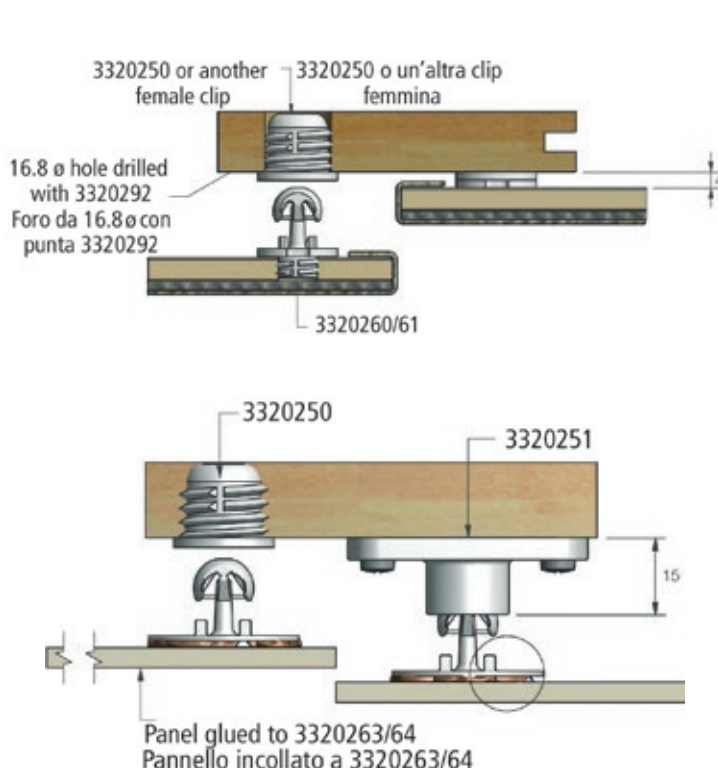

VELA FERRAMENTA/CORDAME COPERTURE/BANDIERE RIVESTIMENTI



**Fissaggio Pannelli Fastmount VL**

Sistema di fissaggio pannelli Fastmount VL range ultraribassato, spessore totale 10mm. Questo innovativo sistema garantisce un facile e sicuro fissaggio di qualsivoglia pannello. La femmina 3320200 si può fissare sia con la vite 3320209 oppure con del mastice. Per l'incasso della femmina viene richiesto un foro da 26mm. Carico 5Kg. La coppia è auto-allineante.



Cod.	OEM	Ref	Accessori	UM	€
3320200	VL-F3	Femmina montaggio a superficie o incasso		PZ	
3320201	VL-M3	Maschio montaggio a superficie		PZ	
3320209	VL-SS3		Vite ribassata	PZ	
3320210	VL-CP3		Centratore per segnare foro maschio	PZ	



3320200



3320201



3320210

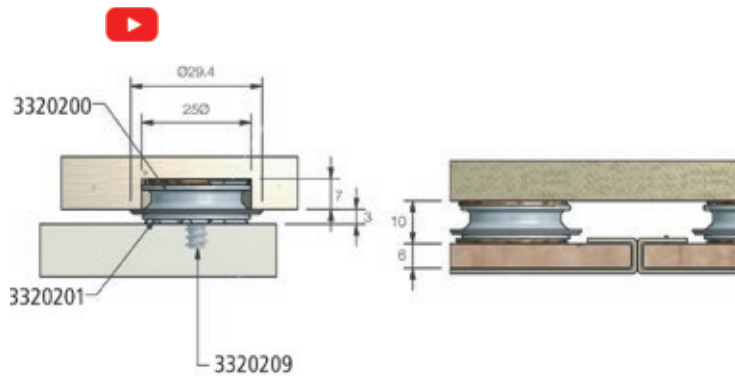

**Fissaggio Pannelli Fastmount STRATLOCK**

Sistema di fissaggio pannelli Fastmount Stratlock range. Questo innovativo sistema garantisce un facile e sicuro fissaggio di qualsivoglia pannello. Questo sistema è a doppio scatto per posizionamento e bloccaggio pannelli. Tutti i componenti femmina sono compatibili con tutti i componenti maschio.



Cod.	OEM	Ref	Accessori	UM	€
3320285	SL-SFA	Femmina montaggio laterale		PZ	
3320286	SL-FC	Femmina a incasso foro ø 40mm		PZ	
3320280	SL-M10	Maschio montaggio a viti o colla. Carico 10Kg		PZ	
3320281	SL-M18	Maschio montaggio a viti o colla. Carico 18Kg		PZ	
3320290	PC-01ST		Centratore per segnare foro maschi	PZ	



3320285



3320286



3320280



3320281

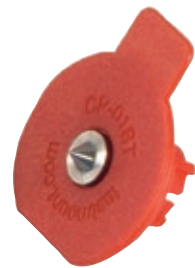

3320290

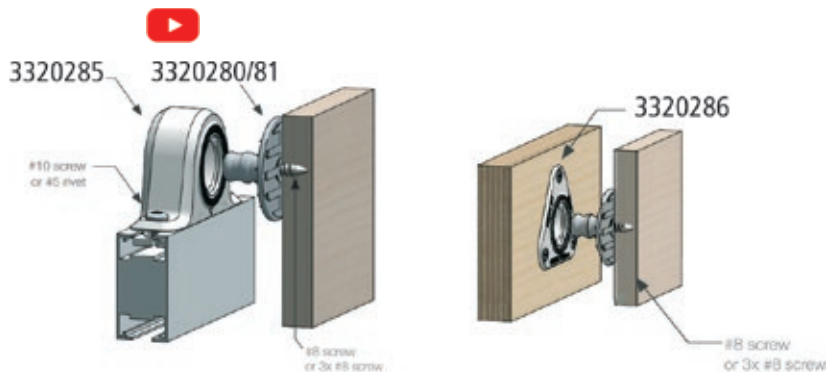

**Teste Bottone Loxx Originali**

Teste bottone di qualità superiore originali tedesche Loxx. Corpo in Ottone o in Acciaio Inox, molla in Acciaio Inox.

Cod.	Ref	Materiale	UM	€
3214200	Testa	Ottone cromato nichelato	PZ	
3214201	Testa	Ottone cromato lucido	PZ	
3214203	Testa	Acciaio Inox AISI 316	PZ	
3214240	Chiavetta		PZ	

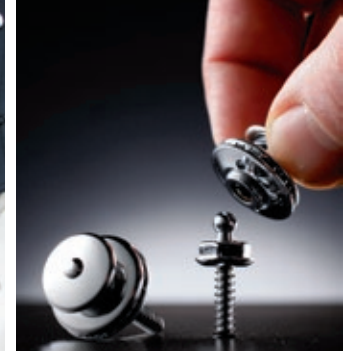

LOXX®

**Teste Bottone Loxx Speciali**

Teste bottone di qualità superiore originali tedesche Loxx. Corpo in Ottone antichizzato o placcato Oro, molla in Acciaio Inox. Ideali per barche classiche e per interni eleganti e raffinati.

Cod.	Ref	Materiale	UM	€
3214220	Testa	Ottone placcato antico	PZ	
3214221	Testa	Ottone placcato Oro	PZ	
3214240	Chiavetta		PZ	



LOXX®

**Vite Mordente Loxx**

Vite mordente autofilettante in Acciaio Inox di qualità superiore originale tedesca Loxx.

Cod.	Ref	UM	€
3214204	Vite autofilettante 12mm	PZ	
3214205	Vite autofilettante 16mm	PZ	
3214215	Vite autofilettante 16mm (testa alta)	PZ	



LOXX®

**Vite con Dado Loxx**

Vite con dado in Ottone cromato/nichelato Loxx.

Cod.	Ref	UM	€
3214206	Vite metrica M5 da 10 mm	PZ	
3214216	Vite metrica M5 da 10 mm (testa alta)	PZ	



LOXX®

**Basetta Loxx**

Basetta di attacco in Ottone cromato/nichelato Loxx.

Cod.	Ref	UM	€
3214207	Basetta	PZ	
3214217	Basetta (testa alta)	PZ	



LOXX®

**Base Attacco Tessuti Loxx**

Base per attacco tessuti in Ottone cromato/nichelato Loxx.

Cod.	Ref	UM	€
3214210	Base attacco tessuti	PZ	



LOXX®

**Attacco Parabrezza Loxx**

Attacco per parabrezza originale tedesco Loxx in Acciaio Inox. Le misure degli attacchi si adattano ai profili parabrezza più usati.

Cod.	H mm	UM	€
3214230	21	PZ	
3214231	24	PZ	



LOXX®



**2 Bottoni Loxx in Blister**

Confezione da 2 bottoni automatici Loxx in Ottone Cromato Nichelato. La confezione comprende le viti e la chiavetta di serraggio.

Cod.	Bottoni in blister	UM	€
3214282	2 pz	CF	



**10 Bottoni Loxx in Blister**

Confezione da 10 bottoni automatici Loxx in Ottone Cromato Nichelato. La confezione comprende la chiavetta di serraggio.

Cod.	Bottoni in blister	UM	€
3214285	10 pz	CF	



**10 Viti Mordenti Loxx in Blister**

Confezione da 10 pezzi di viti mordenti Loxx in Acciaio Inox. La confezione comprende la chiavetta di serraggio.

Cod.	H filettatura mm	Viti in blister	UM	€
3214290	12	10 pz	CF	
3214291	16	10 pz	CF	



**10 Viti con Dado Loxx in Blister**

Confezione da 10 pezzi di viti M5 da 10 mm con dado Loxx.

Cod.	Viti in blister	UM	€
3214294	10 pz	CF	



**10 Basette Attacco Loxx in Blister**

Confezione da 10 pezzi di basette di attacco Loxx. La confezione comprende la chiavetta di serraggio.

Cod.	Basette in blister	UM	€
3214292	10 pz	CF	



**10 Basi Attacco Tessuto Loxx in Blister**

Confezione da 10 pezzi di basi attacco tessuto Loxx. La confezione comprende la chiavetta di serraggio.

Cod.	Basi in blister	UM	€
3214293	10 pz	CF	



**10 Rondelle Alte Loxx in Blister**

Confezione da 10 pezzi di rondelle alte Loxx. Le rondelle alte vanno a sostituire quelle standard presenti nei bottoni Loxx quando serve serrare un tessuto più alto (fino a 4 mm di spessore). La confezione comprende la chiavetta di serraggio.

Cod.	Rondelle in blister	UM	€
3214295	10 pz	CF	



**Chiavi Serraggio Loxx**

Chiavi originali tedesche per bottoni Loxx - Tenax.

Cod.	Ref	UM	€
3214240	Chiave standard piccola	PZ	
3214242	Chiave professionale con manico galleggiante	PZ	



**Terminale**

Terminale Inox per capottine.



Cod.	Per tubo ø mm	UM	€
3230320	20	PZ	
3230322	22	PZ	
3230325	25	PZ	
3230330	30	PZ	

**Giunto T**

Giunto Inox a T per capottine.



Cod.	Per tubo ø mm	UM	€
3230120	20	PZ	
3230122	22	PZ	
3230125	25	PZ	
3230130	30	PZ	

**Snodo**

Snodo Inox per capottine.



Cod.	Per tubo ø mm	UM	€
3220870	22	PZ	
3220871	25	PZ	
3220872	30	PZ	

**Giunto TA**

Giunto apribile Inox per capottine. Con viti di sicurezza.



Cod.	Per tubo ø mm	UM	€
3230201	22	PZ	
3230202	25	PZ	
3230203	30	PZ	

**Giunto TAS**

Giunto apribile Inox per capottine. Con perno sfilabile e sicurezza.



Cod.	Per tubo ø mm	UM	€
3230222	22	PZ	
3230225	25	PZ	
3230230	30	PZ	

**Basetta BP**

Base piana Inox con attacco per tendalini.



Cod.	UM	€
3230600	PZ	

**Basetta BPS**

Base piana Inox con attacco per tendalini. Perno sfilabile e sicurezza.



Cod.	UM	€
3230601	PZ	

**Basetta BI**

Base inclinata Inox con attacco per tendalini.



Cod.	UM	€
3230610	PZ	

**Basetta BIS**

Base inclinata Inox con attacco per tendalini. Perno sfilabile e sicurezza.



Cod.	UM	€
3230611	PZ	

**Basetta BL**

Base Inox con attacco laterale per tendalini.



Cod.	UM	€
3230700	PZ	

**Basetta BC**

Base concava Inox per tubo ø 22/25 mm con attacco per tendalini.



Cod.	UM	€
3230800	PZ	

**Basetta BCS**

Base concava Inox per tubo ø 22/25 mm con attacco per tendalini. Perno sfilabile e sicurezza.



Cod.	UM	€
3230801	PZ	

**Basetta BPI**

Base Inox per tendalini con attacco pivotante.



Cod.	UM	€
3230612	PZ	

**Basetta BPIS**

Base Inox per tendalini con attacco pivotante. Perno sfilabile e sicurezza.



Cod.	UM	€
3230613	PZ	

**Tenditore Bimini**

Piastrina tenditore in Acciaio Inox per cavi capottina.



Cod.	Dim mm	UM	€
3230500	54 x 12	PZ	



**Kit Ricambio Cima e Attacchi**

Kit ricambio attacchi per capottine. Contiene: cimetta, 2 attacchi a forcella, 2 boccole, 2 viti con dado e 4 tenditori bimini.



Cod.	UM	€
<b>3266070</b>	CF	

**Attacco a Forcella**

Attacco a forcella in Plastica per capottine.



Cod.	UM	€
<b>3221500</b>	PZ	

**Boccola per Attacco a Forcella**

Boccola in Plastica per attacco a forcella capottine.



Cod.	UM	€
<b>3220200</b>	PZ	

**Terminale**

Terminale in Plastica per capottine.



Cod.	Per tubo ø mm	UM	€
<b>3221020</b>	20	PZ	
<b>3221022</b>	22	PZ	

**Giunto Snodo T**

Giunto snodo in Plastica a T per capottine.



Cod.	Per tubo ø mm	UM	€
<b>3220520</b>	20	PZ	

**Giunto T**

Giunto in Plastica a T per capottine.



Cod.	Per tubo ø mm	Accessori	UM	€
<b>3220522</b>	22		PZ	
<b>3221022</b>	22	Terminale	PZ	

**Giunto Manicotto**

Giunto manicotto in Plastica per capottine.



Cod.	Per tubo ø mm	UM	€
<b>3220220</b>	20	PZ	
<b>3220222</b>	22	PZ	

**Basetta BP**

Basetta piana in Plastica con attacco per tendalini.



Cod.	UM	€
<b>3221712</b>	PZ	

**Basetta AP**

Basetta in Plastica con attacco a parete per tendalini.



Cod.	Colore	UM	€
<b>3221714</b>	BIANCO	PZ	
<b>3221824</b>	NERO	PZ	

**Basette AT**

Attacco tendalini per tubo ø 22/25 mm.



Cod.	UM	€
<b>3221722</b>	PZ	

**Basetta Gummy**

Base attacco tendalini da incollare per gommoni.



Cod.	UM	€
<b>3221901</b>	PZ	



**Capottine Tendalini 2 Archi White**

Capottine tendalini sole - acqua a 2 archi. Struttura in Alluminio Anodizzato, tessuto in Poliestere 100% spalmato in PVC. Tubi da 20mm.



MTM

Cod.	Colore	W cm	L cm	H cm	UM	€
<b>3266053</b>	BIANCO	130	180	110	PZ	
<b>3266055</b>	BIANCO	150	180	110	PZ	
<b>3266057</b>	BIANCO	170	180	110	PZ	

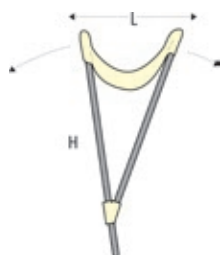
**Capottine Tendalini 2 Archi Blue**

Capottine tendalini sole - acqua a 2 archi. Struttura in Alluminio Anodizzato, tessuto in Poliestere 100% spalmato in PVC. Tubi da 20mm.



MTM

Cod.	Colore	W cm	L cm	H cm	UM	€
<b>3266063</b>	BLUE	130	180	110	PZ	
<b>3266065</b>	BLUE	150	180	110	PZ	
<b>3266067</b>	BLUE	170	180	110	PZ	

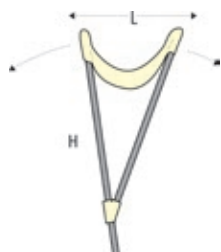
**Capottine Tendalini 3 Archi White**

Capottine tendalini sole - acqua a 3 archi. Struttura in Alluminio laccato bianco, tessuto in Poliestere 100% spalmato in PVC. Tubi da 20mm.



MTM

Cod.	Colore	W cm	L cm	H cm	UM	€
<b>3265055</b>	BIANCO	150	180	110	PZ	
<b>3265057</b>	BIANCO	170	180	110	PZ	
<b>3265058</b>	BIANCO	185	180	110	PZ	
<b>3265060</b>	BIANCO	200	180	110	PZ	

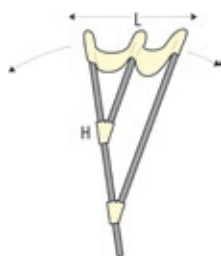
**Capottine Tendalini 3 Archi Blue**

Capottine tendalini sole - acqua a 3 archi. Struttura in Alluminio laccato bianco, tessuto in Poliestere 100% spalmato in PVC. Tubi da 20mm.



MTM

Cod.	Colore	W cm	L cm	H cm	UM	€
<b>3265065</b>	BLUE	150	180	110	PZ	
<b>3265067</b>	BLUE	170	180	110	PZ	
<b>3265068</b>	BLUE	185	180	110	PZ	
<b>3265070</b>	BLUE	200	180	110	PZ	

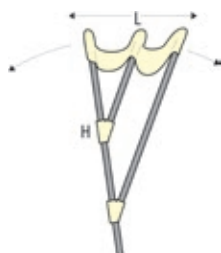

**Capottine Tendalini + Alte 3 Archi White**

Capottine tendalini sole - acqua a 3 archi. Struttura in Alluminio laccato bianco, tessuto in Poliestere 100% spalmato in PVC. Tubi da 20mm.

Cod.	Colore	W cm	L cm	H cm	UM	€
3265255	BIANCO	150	180	140	PZ	
3265257	BIANCO	170	180	140	PZ	
3265258	BIANCO	185	180	140	PZ	
3265260	BIANCO	200	180	140	PZ	
3265262	BIANCO	225	180	140	PZ	

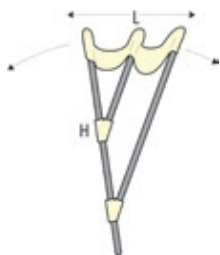

MTM

**Capottine Tendalini + Alte 3 Archi Blue**

Capottine tendalini sole - acqua a 3 archi. Struttura in Alluminio laccato bianco, tessuto in Poliestere 100% spalmato in PVC. Tubi da 20mm.

Cod.	Colore	W cm	L cm	H cm	UM	€
3265265	BLUE	150	180	140	PZ	
3265267	BLUE	170	180	140	PZ	
3265268	BLUE	185	180	140	PZ	
3265270	BLUE	200	180	140	PZ	
3265272	BLUE	225	180	140	PZ	

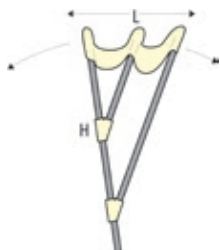

MTM

**Capottine Tendalini + Alte 3 Archi Inox White**

Capottine tendalini sole - acqua a 3 archi. Struttura in Acciaio Inox, tessuto in Poliestere 100% spalmato in PVC. Tubi da 22mm.

Cod.	Colore	W cm	L cm	H cm	UM	€
3265357	BIANCO	185	200	140	PZ	
3265360	BIANCO	200	200	140	PZ	
3265362	BIANCO	230	235	140	PZ	
3265365	BIANCO	245	235	140	PZ	

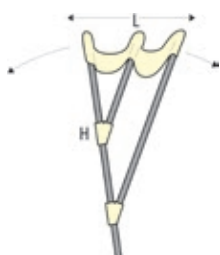

MTM

**Capottine Tendalini + Alte 3 Archi Inox Blue**

Capottine tendalini sole - acqua a 3 archi. Struttura in Acciaio Inox, tessuto in Poliestere 100% spalmato in PVC. Tubi da 22mm.

Cod.	Colore	W cm	L cm	H cm	UM	€
3265367	BLUE	185	200	140	PZ	
3265370	BLUE	200	180	140	PZ	
3265372	BLUE	230	235	140	PZ	
3265375	BLUE	245	235	140	PZ	

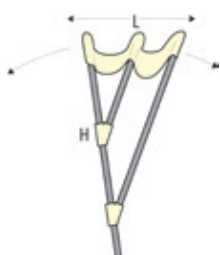

MTM



**Capottine Tendalini 3 Archi Bimini**

Capottine tendalini sole acqua a 3 archi con telaio in Alluminio laccato bianco e tessuto in Poliestere 100% spalmato PVC. Tubi da 20mm.

L.M.  
TESSILMARE

Cod.	W cm	L cm	H cm	UM	€
<b>3265015</b>	150	180	110	PZ	
<b>3265017</b>	170	180	110	PZ	
<b>3265020</b>	200	180	110	PZ	
<b>3265022</b>	225	180	110	PZ	

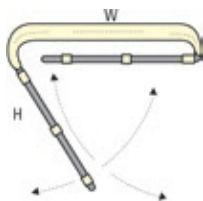
**Capottine Tendalini 3 Archi Bimini Top**

Capottine tendalini sole acqua a 3 archi con telaio in Alluminio laccato bianco e tessuto in Poliestere 100% spalmato PVC. Tubi da 20mm.

L.M.  
TESSILMARE

Cod.	W cm	L cm	H cm	UM	€
<b>3265215</b>	150	180	140	PZ	
<b>3265217</b>	170	180	140	PZ	
<b>3265220</b>	200	180	140	PZ	

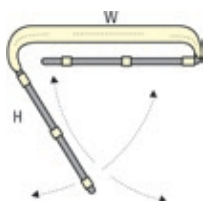
**Capottine Tendalini 4 Archi Fly**

Capottine tendalini sole acqua a 2 archi con telaio in Alluminio laccato bianco e tessuto in Poliestere 100% spalmato PVC. Tubi da 25mm.

L.M.  
TESSILMARE

Cod.	W cm	L cm	H cm	UM	€
<b>3268022</b>	225	225	140	PZ	
<b>3268024</b>	240	225	140	PZ	
<b>3268025</b>	255	225	140	PZ	
<b>3268027</b>	270	260	140	PZ	
<b>3268030</b>	295	260	130	PZ	

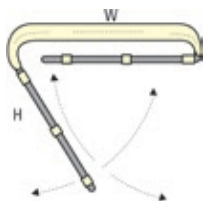
**Capottine Tendalini 2 Archi High Speed**

Capottine tendalini sole acqua a 2 archi con telaio in Alluminio laccato bianco e tessuto in Poliestere 100% spalmato PVC. Tubi da 25mm.

L.M.  
TESSILMARE

Cod.	W cm	L cm	H cm	UM	€
<b>3267017</b>	170	195	95	PZ	
<b>3267020</b>	200	200	110	PZ	
<b>3267022</b>	225	215	115	PZ	

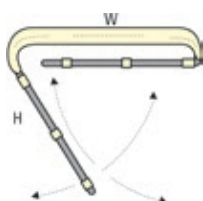



**Capottine Tendalini 3 Archi BimInox White**

Capottine tendalini sole - acqua a 3 archi smontabili. Struttura in Acciaio Inox 316, tessuto in Poliestere 100% spalmato in PVC. Tubi da 22mm. Le capottine si possono fissare a modo di Roll-Bar con i supporti opzionali Pole.



Cod.	Colore	W cm	L cm	H cm	Accessori	UM	€
3265457	Bianco	170	180	140		PZ	
3265460	Bianco	200	180	140		PZ	
3265462	Bianco	230	180	140		PZ	
3265465	Bianco	250	180	140		PZ	
3265400					Asta supporto Pole	CP	

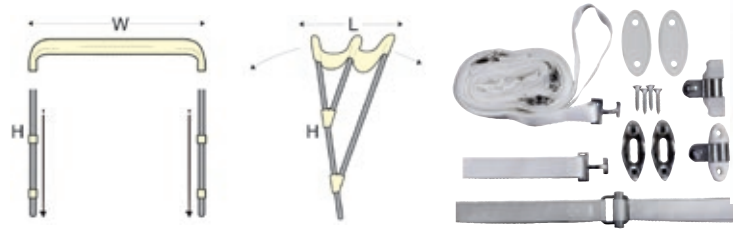

**Capottine Tendalini 3 Archi BimInox Blue**

Capottine tendalini sole - acqua a 3 archi smontabili. Struttura in Acciaio Inox 316, tessuto in Poliestere 100% spalmato in PVC. Tubi da 22mm. Le capottine si possono fissare a modo di Roll-Bar con i supporti opzionali Pole.



Cod.	Colore	W cm	L cm	H cm	Accessori	UM	€
3265467	Blue	170	180	140		PZ	
3265470	Blue	200	180	140		PZ	
3265472	Blue	230	180	140		PZ	
3265475	Blue	250	180	140		PZ	
3265400					Asta supporto Pole	CP	

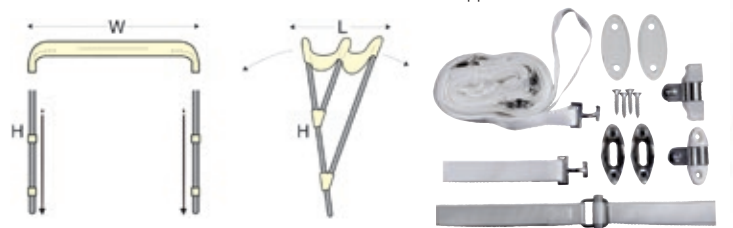

**Capottine Tendalini Aria**

Capottina tendalino sole - acqua dal design aerodinamico e snello che crea più ombra rispetto alle capottine normali. Con innovativo sistema di chiusura che ripiega la capottina su se stessa senza la necessità di togliere la struttura. Struttura in Acciaio Inox 316, tessuto in Poliestere 100% spalmato in PVC. Telaio e telo da acquistare separatamente. Tubi da 25mm.



Cod.	Ref	W cm	L cm	H cm	Telo	UM	€
3265315	Telaio 150	150	210	120		PZ	
3265333					BIANCO	PZ	
3265334					BEIGE	PZ	
3265335					BLUE NAVY	PZ	
3265317	Telaio 170	170	210	120		PZ	
3265337					BIANCO	PZ	
3265338					BEIGE	PZ	
3265339					BLUE NAVY	PZ	
3265318	Telaio 185	185	210	120		PZ	
3265340					BIANCO	PZ	
3265341					BEIGE	PZ	
3265342					BLUE NAVY	PZ	
3265320	Telaio 200	200	210	120		PZ	
3265343					BIANCO	PZ	
3265344					BEIGE	PZ	
3265345					BLUE NAVY	PZ	
3265321	Telaio 215	215	210	120		PZ	
3265346					BIANCO	PZ	
3265347					BEIGE	PZ	
3265348					BLUE NAVY	PZ	
3265323	Telaio 230	230	210	120		PZ	
3265349					BIANCO	PZ	
3265350					BEIGE	PZ	
3265351					BLUE NAVY	PZ	
3265324	Telaio 245	245	210	120		PZ	
3265352					BIANCO	PZ	
3265353					BEIGE	PZ	
3265354					BLUE NAVY	PZ	



**Segnale A (ALFA)**

Subacqueo in immersione.  
Mantenetevi lontano e procedete  
adagio.



Cod.	cm	UM	€
3405101	20 x 30	PZ	
3405161	40 x 60	PZ	

**Segnale E (ECHO)**

Accostando a dritta.



Cod.	cm	UM	€
3405105	20 x 30	PZ	
3405165	40 x 60	PZ	

**Segnale I (INDIA)**

Accostando a sinistra.

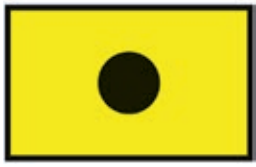

Cod.	cm	UM	€
3405109	20 x 30	PZ	
3405169	40 x 60	PZ	

**Segnale M (MIKE)**

La mia nave è ferma e senza  
abbrivio.



Cod.	cm	UM	€
3405113	20 x 30	PZ	
3405173	40 x 60	PZ	

**Segnale Q (QUEBEC)**

Nave indenne chiedo libera  
pratica.



Cod.	cm	UM	€
3405117	20 x 30	PZ	
3405177	40 x 60	PZ	

**Segnale B (BRAVO)**

Sto imbarcando, sbarcando o  
trasportando merci pericolose.



Cod.	cm	UM	€
3405102	20 x 30	PZ	
3405162	40 x 60	PZ	

**Segnale F (FOXTROT)**

In avaria, comunicate con me.

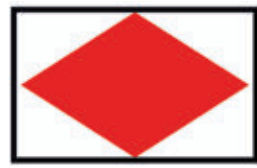

Cod.	cm	UM	€
3405106	20 x 30	PZ	
3405166	40 x 60	PZ	

**Segnale J (JULIET)**

Ho un incendio a bordo e  
trasporto merci pericolose.  
Mantenetevi lontano.



Cod.	cm	UM	€
3405110	20 x 30	PZ	
3405170	40 x 60	PZ	

**Segnale N (NOVEMBER)**

No negativo.



Cod.	cm	UM	€
3405114	20 x 30	PZ	
3405174	40 x 60	PZ	

**Segnale R (ROMEO)**

Segnale di procedura.



Cod.	cm	UM	€
3405118	20 x 30	PZ	
3405178	40 x 60	PZ	

**Segnale C (CHARLIE)**

Si affermativo.



Cod.	cm	UM	€
3405103	20 x 30	PZ	
3405163	40 x 60	PZ	

**Segnale G (GOLF)**

Richiedo pilota.



Cod.	cm	UM	€
3405107	20 x 30	PZ	
3405167	40 x 60	PZ	

**Segnale K (KILO)**

Desidero comunicare con voi.



Cod.	cm	UM	€
3405111	20 x 30	PZ	
3405171	40 x 60	PZ	

**Segnale O (OSCAR)**

Uomo in mare.



Cod.	cm	UM	€
3405115	20 x 30	PZ	
3405175	40 x 60	PZ	

**Segnale S (SIERRA)**

Le mie macchine stanno andando  
indietro.



Cod.	cm	UM	€
3405119	20 x 30	PZ	
3405179	40 x 60	PZ	

**Segnale D (DELTA)**

Mantenetevi lontano; difficoltà di  
manovra.



Cod.	cm	UM	€
3405104	20 x 30	PZ	
3405164	40 x 60	PZ	

**Segnale H (HOTEL)**

Ho il pilota a bordo.



Cod.	cm	UM	€
3405108	20 x 30	PZ	
3405168	40 x 60	PZ	

**Segnale L (LIMA)**

Fermate immediatamente la  
vostra nave.



Cod.	cm	UM	€
3405112	20 x 30	PZ	
3405172	40 x 60	PZ	

**Segnale P (PAPA)**

Tutti debbono rientrare a bordo:  
stiamo per salpare.



Cod.	cm	UM	€
3405116	20 x 30	PZ	
3405176	40 x 60	PZ	

**Segnale T (TANGO)**

Mantenetevi lontano, sono  
impegnato in operazioni di pesca  
a due battelli.



Cod.	cm	UM	€
3405120	20 x 30	PZ	
3405180	40 x 60	PZ	



**Segnale U (UNIFORM)**

State andando verso un pericolo.



Cod.	cm	UM	€
3405121	20 x 30	PZ	
3405181	40 x 60	PZ	

**Segnale Y (YANKEE)**

La mia ancora sta arando.



Cod.	cm	UM	€
3405125	20 x 30	PZ	
3405185	40 x 60	PZ	

**Segnale 2**

Segnale numero 2.

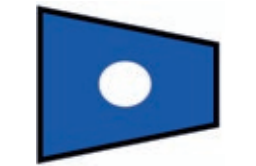

Cod.	cm	UM	€
3405142	20 x 30	PZ	
3405192	40 x 60	PZ	

**Segnale 6**

Segnale numero 6.



Cod.	cm	UM	€
3405146	20 x 30	PZ	
3405196	40 x 60	PZ	

**Segnale 0**

Segnale numero 0.



Cod.	cm	UM	€
3405150	20 x 30	PZ	
3405188	40 x 60	PZ	

**Segnale V (VICTOR)**

Richiedo assistenza.



Cod.	cm	UM	€
3405122	20 x 30	PZ	
3405182	40 x 60	PZ	

**Segnale Z (ZULU)**

Richiedo un rimorchiatore.



Cod.	cm	UM	€
3405126	20 x 30	PZ	
3405186	40 x 60	PZ	

**Segnale 3**

Segnale numero 3.

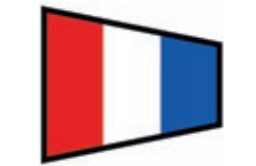

Cod.	cm	UM	€
3405143	20 x 30	PZ	
3405193	40 x 60	PZ	

**Segnale 7**

Segnale numero 7.



Cod.	cm	UM	€
3405147	20 x 30	PZ	
3405197	40 x 60	PZ	

**Segnale Ripetitore 1 (PRIMO)**

Cod.	cm	UM	€
3405151	20 x 30	PZ	
3405131	40 x 60	PZ	

**Segnale W (WHISKY)**

Richiedo assistenza medica.



Cod.	cm	UM	€
3405123	20 x 30	PZ	
3405183	40 x 60	PZ	

**Segnale Intelligence**

Messaggio compreso.

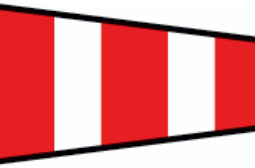

Cod.	cm	UM	€
3405130	20 x 30	PZ	
3405190	40 x 60	PZ	

**Segnale 4**

Segnale numero 4.



Cod.	cm	UM	€
3405144	20 x 30	PZ	
3405194	40 x 60	PZ	

**Segnale 8**

Segnale numero 8.



Cod.	cm	UM	€
3405148	20 x 30	PZ	
3405198	40 x 60	PZ	

**Segnale Ripetitore 2 (SECONDO)**

Cod.	cm	UM	€
3405152	20 x 30	PZ	
3405132	40 x 60	PZ	

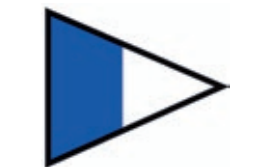
**Segnale X (X RAY)**

Sospendete quello che state facendo e attenzione ai miei segnali.



Cod.	cm	UM	€
3405124	20 x 30	PZ	
3405184	40 x 60	PZ	

**Segnale 1**

Segnale numero 1.

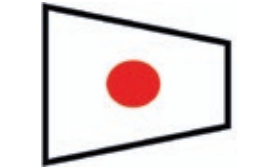

Cod.	cm	UM	€
3405141	20 x 30	PZ	
3405191	40 x 60	PZ	

**Segnale 5**

Segnale numero 5.

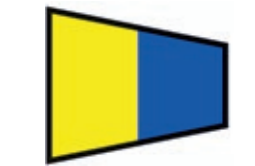

Cod.	cm	UM	€
3405145	20 x 30	PZ	
3405195	40 x 60	PZ	

**Segnale 9**

Segnale numero 9.



Cod.	cm	UM	€
3405149	20 x 30	PZ	
3405199	40 x 60	PZ	

**Segnale Ripetitore 3 (TERZO)**

Cod.	cm	UM	€
3405153	20 x 30	PZ	
3405133	40 x 60	PZ	

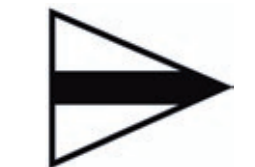

**Gran Pavese - Codice Internazionale**

Confezioni con 40 bandiere del codice internazionale di segnalazione. Leggere ed economiche in Nylon, spesse e resistenti in Poliestere.

Cod.	cm	Tipo	Materiale	UM	€
3405014	14 x 20	Leggero	NYLON	CF	
3405020	20 x 30	Leggero	NYLON	CF	
3405520	20 x 30	H.D.	POLIESTERE	CF	
3405530	30 x 45	H.D.	POLIESTERE	CF	

**Contenitore in Tessuto per Bandiere**

Contenitore portabandiere in tessuto per bandiere di segnalazione.

Cod.	UM	€
3405202	PZ	

**- BANDIERE DI NAVIGAZIONE EXTRA U.E. -****Bandiera U.S.A.**

Bandiere in tessuto di Poliestere di qualità.



Cod.	cm	UM	€
3404520	20 x 30	PZ	
3404530	30 x 45	PZ	
3404540	40 x 60	PZ	
3404550	50 x 75	PZ	

**Bandiera Russia**

Bandiere in tessuto di Poliestere di qualità.



Cod.	cm	UM	€
3404720	20 x 30	PZ	
3404730	30 x 45	PZ	
3404740	40 x 60	PZ	
3404750	50 x 75	PZ	

**Bandiera Inghilterra**

Bandiere in tessuto di Poliestere di qualità.



Cod.	cm	UM	€
3400920	20 x 30	PZ	
3400930	30 x 45	PZ	
3400940	40 x 60	PZ	
3400950	50 x 75	PZ	

**Bandiera Ucraina**

Bandiere in tessuto di Poliestere di qualità.



Cod.	cm	UM	€
3404620	20 x 30	PZ	
3404630	30 x 45	PZ	
3404640	40 x 60	PZ	
3404650	50 x 75	PZ	

**Bandiera Serbia**

Bandiere in tessuto di Poliestere di qualità.



Cod.	cm	UM	€
3404820	20 x 30	PZ	
3404830	30 x 45	PZ	
3404840	40 x 60	PZ	
3404850	50 x 75	PZ	

**Bandiera Montenegro**

Bandiere in tessuto di Poliestere di qualità.



Cod.	cm	UM	€
3402820	20 x 30	PZ	
3402830	30 x 45	PZ	

**Bandiera Bosnia Herzegovina**

Bandiere in tessuto di Poliestere di qualità.



Cod.	cm	UM	€
3402520	20 x 30	PZ	
3402530	30 x 45	PZ	

**Bandiera Albania**

Bandiere in tessuto di Poliestere di qualità.



Cod.	cm	UM	€
3401420	20 x 30	PZ	
3401430	30 x 45	PZ	

**Bandiera Turchia**

Bandiere in tessuto di Poliestere di qualità.



Cod.	cm	UM	€
3404320	20 x 30	PZ	
3404330	30 x 45	PZ	
3404340	40 x 60	PZ	
3404350	50 x 75	PZ	

**Bandiera Egitto**

Bandiere in tessuto di Poliestere di qualità.



Cod.	cm	UM	€
3404020	20 x 30	PZ	
3404030	30 x 45	PZ	
3404040	40 x 60	PZ	
3404050	50 x 75	PZ	

**Bandiera Tunisia**

Bandiere in tessuto di Poliestere di qualità.



Cod.	cm	UM	€
3404120	20 x 30	PZ	
3404130	30 x 45	PZ	
3404140	40 x 60	PZ	
3404150	50 x 75	PZ	

**Bandiera S.Vincent and Grenadines**

Bandiere in tessuto di Poliestere di qualità.



Cod.	cm	UM	€
3403920	20 x 30	PZ	
3403930	30 x 45	PZ	
3403940	40 x 60	PZ	
3403950	50 x 75	PZ	



**Bandiera Italia**Bandiere in tessuto di Poliestere di qualità. 

Cod.	cm	UM	€
3400020	20 x 30	PZ	
3400030	30 x 45	PZ	
3400040	40 x 60	PZ	
3400050	50 x 75	PZ	
3400070	70 x 100	PZ	
3400080	80 x 120	PZ	

**Bandiera Germania**Bandiere in tessuto di Poliestere di qualità. 

Cod.	cm	UM	€
3400220	20 x 30	PZ	
3400230	30 x 45	PZ	
3400240	40 x 60	PZ	
3400250	50 x 75	PZ	

**Bandiera Francia**Bandiere in tessuto di Poliestere di qualità. 

Cod.	cm	UM	€
3400720	20 x 30	PZ	
3400730	30 x 45	PZ	
3400740	40 x 60	PZ	
3400750	50 x 75	PZ	

**Bandiera Austria**Bandiere in tessuto di Poliestere di qualità. 

Cod.	cm	UM	€
3400120	20 x 30	PZ	
3400130	30 x 45	PZ	
3400140	40 x 60	PZ	
3400150	50 x 75	PZ	

**Bandiera Croazia**Bandiere in tessuto di Poliestere di qualità. 

Cod.	cm	UM	€
3400420	20 x 30	PZ	
3400430	30 x 45	PZ	
3400440	40 x 60	PZ	
3400450	50 x 75	PZ	

**Bandiera Slovenia**Bandiere in tessuto di Poliestere di qualità. 

Cod.	cm	UM	€
3400520	20 x 30	PZ	
3400530	30 x 45	PZ	
3400540	40 x 60	PZ	
3400550	50 x 75	PZ	

**Bandiera Spagna**Bandiere in tessuto di Poliestere di qualità. 

Cod.	cm	UM	€
3400820	20 x 30	PZ	
3400830	30 x 45	PZ	
3400840	40 x 60	PZ	
3400850	50 x 75	PZ	

**Bandiera Macedonia**Bandiere in tessuto di Poliestere di qualità. 

Cod.	cm	UM	€
3402720	20 x 30	PZ	
3402730	30 x 45	PZ	

**Bandiera Grecia**Bandiere in tessuto di Poliestere di qualità. 

Cod.	cm	UM	€
3400320	20 x 30	PZ	
3400330	30 x 45	PZ	
3400340	40 x 60	PZ	
3400350	50 x 75	PZ	

**Bandiera Svezia**Bandiere in tessuto di Poliestere di qualità. 

Cod.	cm	UM	€
3402220	20 x 30	PZ	
3402230	30 x 45	PZ	
3402240	40 x 60	PZ	
3402250	50 x 75	PZ	

**Bandiera Norvegia**Bandiere in tessuto di Poliestere di qualità. 

Cod.	cm	UM	€
3402320	20 x 30	PZ	
3402330	30 x 45	PZ	
3402340	40 x 60	PZ	
3402350	50 x 75	PZ	

**Bandiera Danimarca**Bandiere in tessuto di Poliestere di qualità. 

Cod.	cm	UM	€
3402120	20 x 30	PZ	
3402130	30 x 45	PZ	
3402140	40 x 60	PZ	
3402150	50 x 75	PZ	

**Bandiera Olanda**Bandiere in tessuto di Poliestere di qualità. 

Cod.	cm	UM	€
3402020	20 x 30	PZ	
3402030	30 x 45	PZ	
3402040	40 x 60	PZ	
3402050	50 x 75	PZ	

**Bandiera Belgio**Bandiere in tessuto di Poliestere di qualità. 

Cod.	cm	UM	€
3404920	20 x 30	PZ	
3404930	30 x 45	PZ	
3404940	40 x 60	PZ	
3404950	50 x 75	PZ	

**Bandiera Malta**Bandiere in tessuto di Poliestere di qualità. 

Cod.	cm	UM	€
3404420	20 x 30	PZ	
3404430	30 x 45	PZ	
3404440	40 x 60	PZ	
3404450	50 x 75	PZ	

**Bandiera Romania**Bandiere in tessuto di Poliestere di qualità. 

Cod.	cm	UM	€
3402920	20 x 30	PZ	
3402930	30 x 45	PZ	

**Bandiera Bulgaria**Bandiere in tessuto di Poliestere di qualità. 

Cod.	cm	UM	€
3402620	20 x 30	PZ	
3402630	30 x 45	PZ	

**Bandiera Ungheria**Bandiere in tessuto di Poliestere di qualità. 

Cod.	cm	UM	€
3400620	20 x 30	PZ	
3400630	30 x 45	PZ	
3400640	40 x 60	PZ	
3400650	50 x 75	PZ	

**Bandiera Rep. Ceca**Bandiere in tessuto di Poliestere di qualità. 

Cod.	cm	UM	€
3404220	20 x 30	PZ	
3404230	30 x 45	PZ	
3404240	40 x 60	PZ	
3404250	50 x 75	PZ	

**Bandiera Slovacchia**Bandiere in tessuto di Poliestere di qualità. 

Cod.	cm	UM	€
3403720	20 x 30	PZ	
3403730	30 x 45	PZ	



**Bandiera Unione**

Bandiera in tessuto di Poliestere di qualità.

Cod.	cm	UM	€
3401520	20 x 30	PZ	
3401530	30 x 45	PZ	
3401540	40 x 60	PZ	
3401550	50 x 75	PZ	

**Bandiera Italia UE**

Bandiera in tessuto di Poliestere di qualità.

Cod.	cm	UM	€
3401020	20 x 30	PZ	
3401030	30 x 45	PZ	

**- BANDIERE REGIONALI E LOCALI -****Guidone Venezia**

Guidone Venezia con code tagliate in tessuto di Poliestere di qualità.

Cod.	cm	UM	€
3406220	22 x 44	PZ	
3406230	30 x 60	PZ	

**Bandiera Sicilia**

Bandiera in tessuto di Poliestere di qualità.

Cod.	cm	UM	€
3406320	20 x 30	PZ	
3406330	30 x 45	PZ	
3406340	40 x 60	PZ	

**Bandiera Sardegna**

Bandiera in tessuto di Poliestere di qualità.

Cod.	cm	UM	€
3406020	20 x 30	PZ	
3406030	30 x 45	PZ	
3406040	40 x 60	PZ	

**Bandiera Corsica**

Bandiera in tessuto di Poliestere di qualità.

Cod.	cm	UM	€
3406120	20 x 30	PZ	
3406130	30 x 45	PZ	
3406140	40 x 60	PZ	

**- BANDIERE DI SEGNALAZIONE -****Bandiera di Segnalazione Rossa**

Bandiera di segnalazione rossa per spiagge da balneazione.

Cod.	cm	UM	€
3406420	20 x 30	PZ	
3406430	30 x 45	PZ	
3406440	40 x 60	PZ	

**Bandiera di Segnalazione Gialla**

Bandiera di segnalazione gialla per spiagge da balneazione.

Cod.	cm	UM	€
3406520	20 x 30	PZ	
3406530	30 x 45	PZ	
3406540	40 x 60	PZ	

**Bandiera di Segnalazione Bianca**

Bandiera di segnalazione bianca per spiagge da balneazione.

Cod.	cm	UM	€
3406620	20 x 30	PZ	
3406630	30 x 45	PZ	
3406640	40 x 60	PZ	

**Segnale Sub (Italia)**

Segnale sub Italia.

Cod.	cm	UM	€
3405100	20 x 30	PZ	



Bandiera Adesiva Italia

Bandiera adesiva Italia.

Cod.	Dim mm	UM	€
3418012	120 x 160	PZ	
3418016	160 x 240	PZ	
3418516	160 x 240 Gommata per battelli pneumatici	PZ	



Table Adesive Segnaletica Navale

Table adesive di sicurezza navale.

Cod.	Segnale	Dim mm	UM	€
3419050	Zattera di salvataggio	150 x 150	PZ	
3419051	Salvagente anulare	150 x 150	PZ	
3419052	Giubbotto salvagente	150 x 150	PZ	
3419053	Razzo di segnalazione	150 x 150	PZ	



New



Tabella Adesiva Bandiere Nazionali

Tabella adesiva bandiere nazionali.

Cod.	mm	UM	€
3419205	160 x 240	PZ	



Tabella Adesiva Codici Internazionali

Tabella adesiva codici internazionali.

Cod.	mm	UM	€
3419201	160 x 240 (Con simbologia)	PZ	
3419200	120 x 160 (Senza simbologia)	PZ	



Tabella Adesiva Segnali di Salvataggio

Tabella adesiva segnali di salvataggio.

Cod.	mm	UM	€
3419203	160 x 240	PZ	



Tabella Adesiva Codici da Regata

Tabella adesiva codici da regata.

Cod.	mm	UM	€
3419202	155 x 175	PZ	

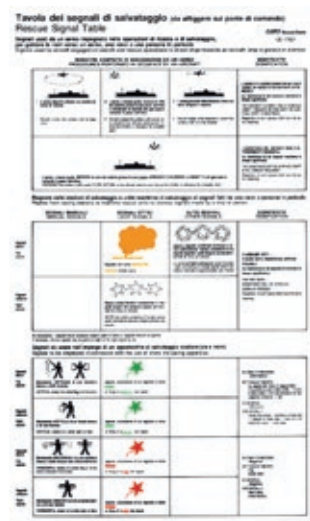

Tabella Adesiva Semafori e Segnali Luminosi

Tabella adesiva semafori e segnali luminosi.

Cod.	mm	UM	€
3419204	160 x 240	PZ	



Tabella Adesiva Nodi Marineri

Tabella adesiva nodi marineri.

Cod.	mm	UM	€
3419206	160 x 240	PZ	

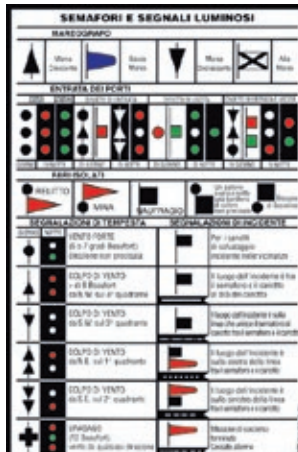
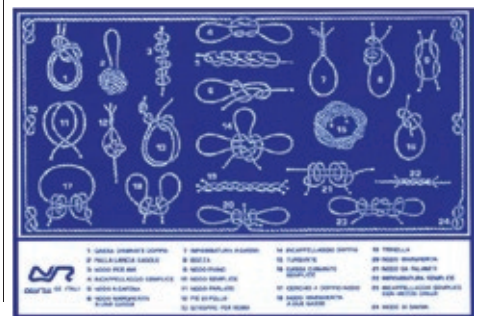

**Rosa dei Venti Gold Ø 80**

Tabella adesiva Ø 80 mm "Rosa dei venti Gold"

Cod.	Tipo adesivo	UM	€
3418900	in Rilievo	PZ	
3418910	Classico piatto	PZ	

**Rosa dei Venti Ice**

Tabella adesiva "Rosa dei venti Ice".

Cod.	Tipo adesivo	Ø mm	UM	€
3418901	in Rilievo	80	PZ	
3418911	Classico piatto	80	PZ	
3418917	Classico piatto	150	PZ	

**Divieto Scarpe Ø 80**

Tabella adesiva Ø 80 mm "Divieto scarpe"

Cod.	Tipo adesivo	UM	€
3418902	in Rilievo	PZ	
3418912	Classico piatto	PZ	

**Vietato Fumare Ø 80**

Tabella adesiva Ø 80 mm "Vietato fumare"

Cod.	Tipo adesivo	UM	€
3418903	in Rilievo	PZ	
3418913	Classico piatto	PZ	

**Divieto Ostruire il WC Ø 80**

Tabella adesiva Ø 80 mm "Divieto ostruire il WC"

Cod.	Tipo adesivo	UM	€
3418906	in Rilievo	PZ	
3418916	Classico piatto	PZ	

**Divieto Reggisenò Ø 80**

Tabella adesiva Ø 80 mm "Divieto reggisenò"

Cod.	Tipo adesivo	UM	€
3418904	in Rilievo	PZ	
3418914	Classico piatto	PZ	

**Divieto Bikini Ø 80**

Tabella adesiva Ø 80 mm "Divieto bikini"

Cod.	Tipo adesivo	UM	€
3418905	in Rilievo	PZ	
3418915	Classico piatto	PZ	

**Vietato Fumare Ø 150**

Tabella adesiva Ø 150 mm "Vietato fumare"

Cod.	Tipo adesivo	UM	€
3419002	Classico piatto	PZ	

**Divieto Reggisenò Ø 150**

Tabella adesiva Ø 150 mm "Divieto reggisenò"

Cod.	Tipo adesivo	UM	€
3419004	Classico piatto	PZ	

**Divieto Scarpe Ø 150**

Tabella adesiva Ø 150 mm "Divieto scarpe"

Cod.	Tipo adesivo	UM	€
3419001	Classico piatto	PZ	

**- RIVESTIMENTI E STRISCE ANTISCIVOLO -****Strips Antiscivolo Rosh**

Strisce antiscivolo da 2x30cm con bordi arrotondati. Confezione da 5 pezzi in colore bianco oppure nero.

Cod.	Colore	Dim cm	Pz/Confezione	UM	€
3320135	BIANCO	2 x 30	5	PZ	
3320136	NERO	2 x 30	5	PZ	

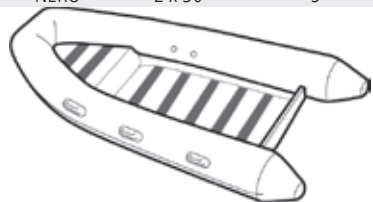

New

**Strips Antiscivolo 3M Safety-Walk**

Strisce antiscivolo autoadesive 3M Safety-Walk confortevoli e igieniche, adatte per tutte le superfici di camminamento. Costruite con sottili granuli strutturati in resina su robusto supporto in Poliestere.

Cod.	Colore	Larghezza cm	L m	UM	€
3324622	NERO	2,5	18,2	MT	
3324625	NERO	5,0	18,2	MT	
3324612	BIANCO	2,5	18,2	MT	
3324615	BIANCO	5,0	18,2	MT	
3324602	TRASPARENTE	2,5	18,2	MT	
3324605	TRASPARENTE	5,0	18,2	MT	



3M



**Strips Antiscivolo in Blister (3 Mt)**

Strisce antiderapanti autoadesive in blister, qualità e grip superiori. Impermeabili, isolanti, confortevoli a piedi nudi, antiscivolo anche bagnate. Per evitare cadute e scivolate in barca, perfette per ponti d'imbarcazioni, gommoni, scale, scalette, passerelle, piani di calpestio.

Composizione: Complesso Elastomero di Poliuretano spalmato su base di Poliester.

Misure: 4 cm x 3 m. Spessore: 1 mm.

Cod.	Colore	Larghezza cm	L m	UM	€
3320111	BIANCO	4	3	PZ	
3320104	SABBIA	4	3	PZ	
3320105	BLUE	4	3	PZ	
3320110	GRIGIO	4	3	PZ	
3320123	GRIGIO PERLA	4	3	PZ	
3320108	NERO	4	3	PZ	
3320124	GIALLO	4	3	PZ	

**Strips Antiscivolo Pretagliate Top Quality**

Strisce antiscivolo di qualità e grip superiori. Pretagliate a 4x35cm con bordi arrotondati e super adesivo AT7. Impermeabili, isolanti, confortevoli anche a piedi nudi. Perfette per ponti d'imbarcazioni, gommoni, scale, passerelle.

Cod.	Colore	Dim cm	Pz/Confezione	UM	€
3320130	BIANCO	4 x 35	10	PZ	
3320131	NERO	4 x 35	10	PZ	

**New**

PROOPLE

**Strips Antiscivolo TBSafe per Gommoni**

Strisce antiscivolo per gommoni e gonfiabili con adesivo AT4 specifico per Hypalon, composito e metalli. Costruite in elastomero flessibile a grana fine con elevate proprietà anti-scivolo, atossico, resistente all'abrasione, ai raggi UV e all'ambiente marino, testato a norma EN13036-4. Confezione da 2 pezzi.

Cod.	Colore	Dim cm	Pz/Confezione	UM	€
3320115	NERO	30 x 60	2	PZ	
3320116	BIANCO	30 x 60	2	PZ	
3320117	GRIGIO	30 x 60	2	PZ	
3320118	AVORIO	30 x 60	2	PZ	

**New**

PROOPLE



**Strips Antiscivolo**

Strisce antiscivolo di qualità e grip superiori, in rotolo spessore 2.1 mm.  
Complesso Elastomero di Poliuretano spalmato su base di Poliestere.  
Impermeabili, isolanti, confortevoli anche a piedi nudi.  
Perfette per ponti d'imbarcazioni, gommoni, scale, passerelle.  
Misure: 2,5 cm x 10 metri - 4 cm x 10 metri - 10 cm x 10 metri.

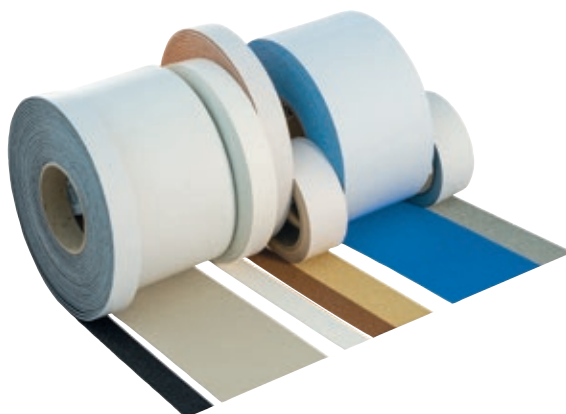

Cod.	Colore	Dim	UM	€
3322511	BIANCO	2,5 cm x 10 mt	MT	
3324011	BIANCO	4 cm x 10 mt	MT	
3321011	BIANCO	10 cm x 10 mt	MT	
3322505	BLUE	2,5 cm x 10 mt	MT	
3324005	BLUE	4 cm x 10 mt	MT	
3321005	BLUE	10 cm x 10 mt	MT	
3322510	GRIGIO	2,5 cm x 10 mt	MT	
3324010	GRIGIO	4 cm x 10 mt	MT	
3321010	GRIGIO	10 cm x 10 mt	MT	
3322508	NERO	2,5 cm x 10 mt	MT	
3324008	NERO	4 cm x 10 mt	MT	
3321008	NERO	10 cm x 10 mt	MT	
3322506	AVORIO	2,5 cm x 10 mt	MT	
3324006	AVORIO	4 cm x 10 mt	MT	
3321006	AVORIO	10 cm x 10 mt	MT	
3322504	SABBIA	2,5 cm x 10 mt	MT	
3324004	SABBIA	4 cm x 10 mt	MT	
3321004	SABBIA	10 cm x 10 mt	MT	
3322503	MOGANO	2,5 cm x 10 mt	MT	
3324003	MOGANO	4 cm x 10 mt	MT	
3321003	MOGANO	10 cm x 10 mt	MT	

**Rivestimento Antiscivolo TBS21 in Rotoli**

Pavimenti antiscivolo professionali in rotoli da 60 cm x 10 m e 128 cm x 5 m. Complesso Elastomero di Poliuretano spalmato su base di Poliestere.  
Spessore: 2,1 mm. Impermeabili, isolanti, confortevoli anche a piedi nudi.  
Per muoversi in sicurezza su imbarcazioni da lavoro e da diporto.  
Perfette per ponti d'imbarcazioni, passerelle e piani di calpestio.



Cod.	Colore	Larghezza cm	L m	UM	€
3325002	BIANCO	60	10	MT	
3326002	BIANCO	128	5	MT	
3325011	AVORIO	60	10	MT	
3326011	AVORIO	128	5	MT	
3325010	GRIGIO	60	10	MT	
3326010	GRIGIO	128	5	MT	
3325007	GRIGIO PERLA	60	10	MT	
3326007	GRIGIO PERLA	128	5	MT	
3325009	NERO	60	10	MT	
3326009	NERO	128	5	MT	
3325001	ARDESIA	60	10	MT	
3326001	ARDESIA	128	5	MT	
3325004	SABBIA	60	10	MT	
3326004	SABBIA	128	5	MT	
3325003	MOGANO	60	10	MT	
3326003	MOGANO	128	5	MT	

**Rivestimento Antiscivolo TBS21 in Piastre**

Pavimenti antiscivolo professionali in piastre da 128 x 90 cm.  
Complesso Elastomero di Poliuretano spalmato su base di Poliestere.  
Spessore piastre: 2,1 mm. Impermeabili, isolanti, confortevoli anche a piedi nudi.  
Per muoversi in sicurezza su imbarcazioni da lavoro e da diporto.  
Perfette per ponti d'imbarcazioni, passerelle, piani di calpestio.



Cod.	Colore	UM	€
3325511	BIANCO	PZ	
3325506	AVORIO	PZ	
3325505	BLUE	PZ	
3325510	GRIGIO	PZ	
3325508	NERO	PZ	
3325501	ARDESIA	PZ	
3325504	SABBIA	PZ	
3325503	MOGANO	PZ	



**Rivestimento Fono-Isolante Fonox-B**

Rivestimento Fono isolante bugnato Fonox, leggero e economico. Facile da applicare, isola dal rumore (10dB).

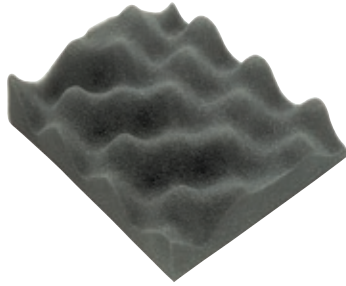

Cod.	>  < mm	dB	cm	UM	€
<b>3317040</b>	30	10	100 x 200	PZ	

**Rivestimento Adesivo Fono/Termo Isolante Fonox-FK**

Fono/Termo isolante adesivo Fonox-FK. Isola da rumore (10 dB) e calore. Rivestimento con fibra di Vetro aluminizzata resistente ad alte temperature. Autoestinguente secondo norme UL94HF1

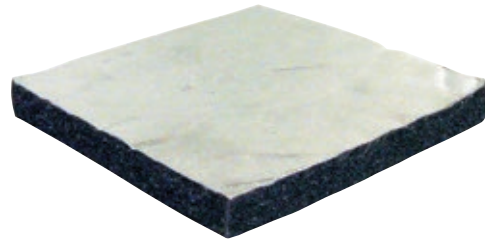

Cod.	>  < mm	dB	cm	UM	€
<b>3317020</b>	16	10	100 x 150	PZ	

**Rivestimento Fono/Termo Isolante Vetral**

Fono/Termo isolante Vetral con inserto in Piombo. Isola da rumore (20 dB) e calore. Rivestimento con fibra di Vetro aluminizzata resistente ad alte temperature. Autoestinguente secondo norme UL94HF1.

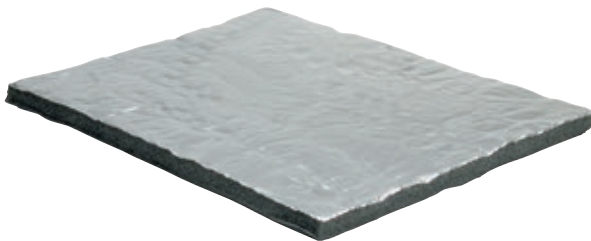

Cod.	>  < mm	dB	cm	UM	€
<b>3317520</b>	14	22	100 x 300	PZ	

**Rivestimento Fono/Termo Isolante Agloabsorber**

Fono/Termo isolante professionale Agloabsorber. Leggerissimo e performante è l'ideale per vani motore e locali macchine. Isolamento 25dB montato su pannelli fino a 2mm. Autoestinguente; resistenza al fuoco in regola con le norme: DIN 4102-FMVSS302-UL94 HBF-M4. Rivestimento con fibra di vetro aluminizzata resistente a temperature fino a 180°C.

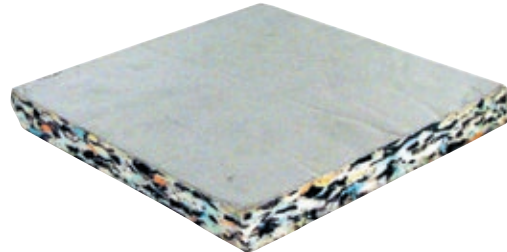

Cod.	>  < mm	dB	cm	UM	€
<b>3317525</b>	20	25	100 x 200	PZ	

**Rivestimento Fono/Termo Isolante SOUNDFIL**

Pannelli adesivi fono/termo isolanti Soundfil con o senza inserto in gomma pesante. Rivestimento in massa polimerica e fibre di Poliestere con protezione in tessuto di fibra di vetro imputrescibile. Consigliata l'applicazione con collante adeguato in base al tipo di parete. Omologazione RINA e Classe 1 di resistenza al fuoco UNI9177.



Cod.	>  < mm	dB	cm	Inserto gomma pesante	UM	€
<b>3317022</b>	20	20	100 x 150	NO	PZ	
<b>3317024</b>	20	30	90 x 150	SI	PZ	

**Rivestimento Fono/Termo Isolante Akustikabsorber**

Fono/Termo isolante con inserto in Gomma pesante, vero e specifico isolante per vani motore e locali macchine di qualsiasi imbarcazione. Isolamento 30dB montato su pannelli fino a 2mm. Da applicare con collante adeguato in base al tipo di parete. Resistenza al fuoco in regola con le norme: DIN4102-FMVSS302-UL94-HBF-M4.

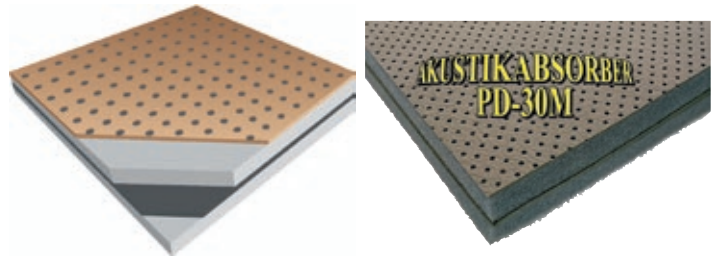

Cod.	>  < mm	dB	cm	UM	€
<b>3317530</b>	30	30	100 x 120	PZ	

**Rivestimento Termoisolante IMATT 20 TS**

Feltro Termoisolante in tessuto di fibra di Vetro rivestito con fibra di Vetro aluminizzata non combustibile. Ideale per tubazioni di scarico e vani motore. Omologazione R.I.Na. CCE33701 - CDS/467-95/TAO. Resistente a temperature fino a 675°. In confezioni da 2 pz.

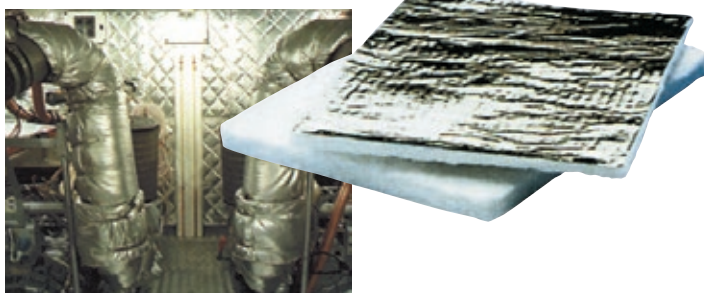

Cod.	>  < mm	cm	UM	€
<b>3320072</b>	20	100 x 150	CF	

**Rivestimento Termoisolante IMATT 10 TR**

Rivestimento Termoisolante in fibra di Vetro tessile rivestito con fibra di Vetro aluminizzata e trapuntata ad alta capacità termica. Non combustibile. Ideale per vani motore e locali macchina. Temperatura di esercizio continua: -30° +550°.



Cod.	>  < mm	cm	UM	€
<b>3320074</b>	10	100 x 150	PZ	



**Coperture Termoisolanti per Tubi Scarico**

Coperture Termo isolanti per tubi scarico in tessuto di Vetro e fibre di Ceramica. Sopportano temperature fino a 800°. Complete di molle Inox per il fissaggio.

Omologazione R.I.Na. CCE33701-CDS/467-95/TAO.



Cod.	Dimensioni cm	Per tubi scarico ø mm	UM	€
3320084	100 x 38	70	PZ	
3320085	100 x 43	85	PZ	
3320086	100 x 48	100	PZ	
3320087	100 x 54	124	PZ	
3320088	100 x 60	150	PZ	
3320089	100 x 68	168	PZ	
3320090	100 x 83	220	PZ	

**Copri Turbo Termoisolanti SMB**

Coperture Termo isolanti in tessuto di Vetro e fibre di Ceramica per turbine motore.

Sopportano temperature fino a 800°.

Complete di molle Inox per il fissaggio.



Cod.	Ref	ø Turbina mm	Larghezza mm	UM	€
3320081	Small	180-200	70-80	PZ	
3320082	Medium	230-250	80-90	PZ	
3320083	Large	290-310	80-90	PZ	

**Nastro Termoisolante Elastico per Alte Temperature**

Nastro Termo isolante elastico Fiberglass-Metal resistente ad altissime temperature. Si compone di tessuto in fibra di Vetro accoppiato a una lamina di Alluminio che lo rende più flessibile. Dotato di proprietà elastiche può essere facilmente applicato anche alle curve degli scarichi. Normalmente 2/3 strati sono sufficienti per la maggior parte delle applicazioni di scarico Diesel. Temperatura massima di esercizio: 600 C°. A scelta si può aggiungere uno strato protettivo esterno di Nastro Elastomero Autoamalgamante resistente ad alte temperature per creare una superficie omogenea.



Cod.	Larghezza mm	Lunghezza m	Spessore mm	Accessori	UM	€
3320076	50	5,5	5		PZ	
3320077	100	5,5	5		PZ	
3320078	75	5	1,15	Nastro Elastomero	PZ	

**Nastro Adesivo per Alte Temperature**

Nastro adesivo in Alluminio per alte temperature. Per finire, fissare e contenere rivestimenti isolanti di tubazioni scarico e vani motore. Intervallo temperature: -40°C / +150°C



Cod.	H mm	L m	UM	€
3320075	50	50	PZ	

**Nastro Isolante Ceramico per Alte Temperature**

Nastro isolante in filo di Ceramica per tubazioni di scarico. Isola e protegge da temperature fino a 800°. Spessore 3 mm.



Cod.	H mm	L m	UM	€
3320055	50	25	PZ	
3320060	100	25	PZ	

**Piastrine Fermapannelli**

Rondelle e piastre in Alluminio per fissare pannelli isolanti.

Le rondelle 3320079 si fissano con viti passanti o autofilettanti.

Le piastre 3320080 possono essere fissate con viti, fibra di vetro o collante epossidico. I pannelli vengono forati dall'arpione sul quale si inserisce la rondella 3320079, poi l'arpione viene piegato per fissare rondella e pannello.



Cod.	Ref	Dimensioni mm	UM	€
3320079	Rondella forata	ø 35	PZ	
3320080	Piastra con arpione	50 x 50 x H70	PZ	

**Colla Pren per Alte Temperature**

Adesivo monocomponente per alte temperature. Per incollaggio di pannelli Fono e Termo isolanti.



Cod.	Latta	UM	€
5720610	850 g	PZ	

