

1

ANCHORING / MOORING / FENDERS BUOYS



Rocker Stopper Stabilizer

Handy, lightweight and easy to use hydrodynamic stabilizer. Avoids rolling and stabilizes the boat, can be used also to reduce drift. Ideal for anchored or moored boats and for floating pontoons.

Number of stoppers needed on each side of the boat:

- 3 up to 8 meters
- 4 up to 11 meters
- 5 up to 13 meters
- 8 up to 15 meters

Code	ø cm	UM	€
3275002	36	PCS	

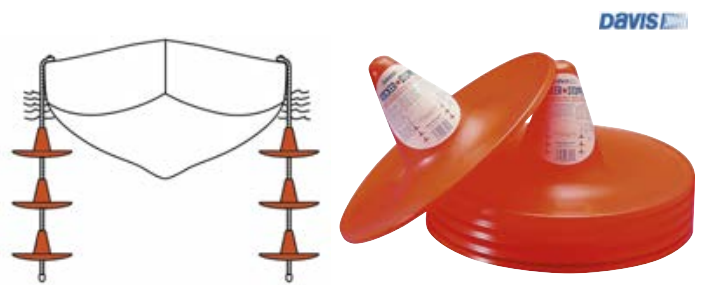

DAVIS

Floating Anchors

Reinforced Polyester drift floating anchor with strong tape straps. Works on the parachute principle that takes advantage of water friction and stabilizes the boat, keeps the bow up to the wind and avoids drifting. The recommended rope should be at least 3 times the length of the boat.

Code	ø cm	L cm	Boat m	UM	€
3271004	45	65	< 6	PCS	
3271005	60	80	< 8	PCS	
3271010	100	150	< 11	PCS	
3271015	150	220	< 13	PCS	



Top Drag Drogue Sea Anchors

PVC coated Rip-Stop Nylon H.Duty drift floating anchor. Nylon tape straps and reinforcements. Works with the parachute principle that takes advantage of water friction and stabilizes the boat, keeps the bow up to the wind and avoids drifting. The recommended rope should be at least 3 times the length of the boat.

Code	ø cm	L cm	Boat m	UM	€
3271206	60	53	< 6	PCS	
3271208	80	70	< 8	PCS	
3271210	107	110	< 10	PCS	
3271213	135	140	< 12	PCS	



MTM QUALITY

Sea-Drage Anchors

High efficiency braking action drogue anchor (50% more than other traditional drogue anchors) thanks to the double chamber with side openings. Heavy duty Oxford Rip-Stop Nylon with stainless steel fittings and Nylon tape straps and reinforcements. Used as drogue anchor to avoid drifting and keep the keel up to the wind, as drift anchor, as stabilizers or as a brake. The recommended rope should be at least 3 times the length of the boat.

Code	ø cm	L cm	Boat m	Boat'	UM	€
3271021	60	122	< 11	24-36	PCS	
3271022	73	156	< 17	36-55	PCS	
3271023	120	191	< 23	55-75	PCS	
3271024	150	224	< 29	75-95	PCS	

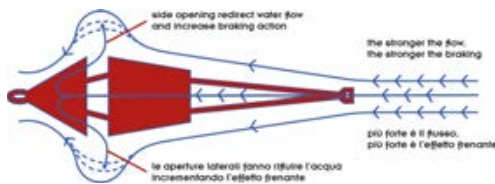

Sea Guardians Para Sea Anchors

Sea Guardians Para-Anchor floating anchors for use in fishing, commercial navigation and pleasurecrafts. They work with the parachute principle for an extraordinary brake in the water. Made of 100% Nylon fabric for exceptional durability and performance in all sea conditions. Light and extremely robust, they are used as anchor, drift or brake in open and deep waters, guaranteeing great stability and safety. The recommended rope should at least be 3 times the length of the boat.

Code	ø cm	Boat m	UM	€
3271108	260	< 9	PCS	
3271112	380	< 12	PCS	
3271116	510	< 14	PCS	
3271120	640	< 18	PCS	



Compact "Hall" Anchor

Galvanized Steel compact anchor.

For: sand - mud.

Often used as a secondary anchor.

Code	L mm	W mm	Kg	UM	€
0104502	290	140	2	PCS	
0104503	310	160	2,8	PCS	
0104504	325	185	3,7	PCS	
0104506	385	205	6	PCS	
0104508	495	230	8	PCS	
0104510	495	245	10	PCS	

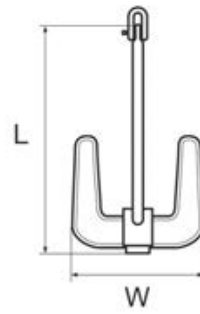

"Hall" Anchor

Galvanized Steel compact "heavy" anchor.

For: sand - mud.

Code	L mm	W mm	Kg	UM	€
0104518	386	325	18	PCS	
0104528	445	380	27	PCS	
0104536	505	420	35	PCS	
0104548	555	450	48	PCS	
0104558	585	500	58	PCS	
0104610	831	584	100	PCS	
0104615	1048	670	150	PCS	

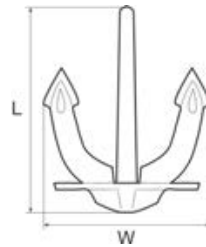

"Danforth" Type Anchor

Galvanized Steel "Danforth" type traditional anchor.

For: sand - mud.

Code	L mm	W mm	Kg	UM	€
0105004	540	400	4	PCS	
0105006	520	460	6	PCS	
0105008	685	510	8	PCS	
0105010	700	510	10	PCS	
0105012	720	520	12	PCS	
0105015	740	610	15	PCS	
0105020	760	660	20	PCS	
0105025	770	660	25	PCS	
0105030	820	700	30	PCS	
0105040	840	710	40	PCS	
0105050	860	750	50	PCS	

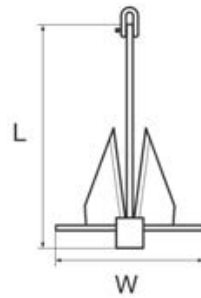

"Pool HHP" Anchor

Galvanized Steel "Pool HHP" (High Holding Power) anchor.

For: sand - mud.

Code	L mm	W mm	Kg	UM	€
0104812	448	323	12	PCS	
0104820	533	386	20	PCS	
0104840	662	479	40	PCS	
0104860	762	550	60	PCS	
0104880	840	608	80	PCS	
0104890	905	653	100	PCS	
0104895	1050	760	150	PCS	

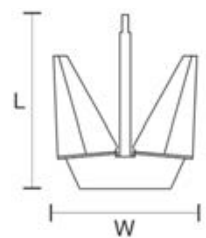

Folding Grapnel Anchor

Galvanized Steel folding grapnel anchor.
For: rocks - stones - sand.
Often used as a secondary anchor.

Code	L mm	W mm	D mm	Kg	UM	€
0104015	310	290	80	1,5	PCS	
0104025	360	330	85	2,5	PCS	
0104032	400	350	95	3,2	PCS	
0104040	450	400	105	4	PCS	
0104060	545	465	120	6	PCS	
0104080	580	540	130	8	PCS	
0104110	655	595	130	10	PCS	

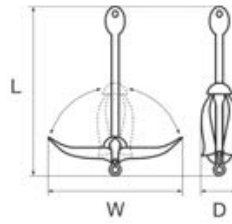

Stainless Steel Folding Grapnel Anchor

Stainless Steel folding grapnel anchor.
For: rocks - stones - sand.
Often used as a secondary anchor.

Code	L mm	W mm	D mm	Kg	UM	€
0104115	310	290	80	1,5	PCS	
0104125	360	330	85	2,5	PCS	
0104132	400	350	95	3,2	PCS	
0104140	450	400	105	4	PCS	
0104160	545	465	120	6	PCS	

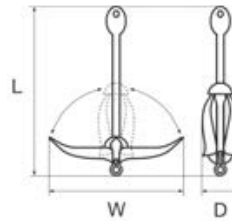

"Bruce" Type Anchor

Galvanized Steel 3 pointer "Bruce" type anchor.
For: sand - mud.

Code	H mm	L mm	W mm	Kg	UM	€
0107502	190	350	295	2	PCS	
0107505	240	470	330	5	PCS	
0107507	265	530	380	7,5	PCS	
0107510	285	560	395	10	PCS	
0107515	315	620	405	15	PCS	
0107520	370	686	470	20	PCS	
0107530	445	800	525	30	PCS	
0107550	470	980	660	50	PCS	

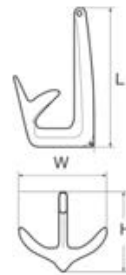

"Bruce" S/Steel Type Anchor

Mirror-polished Stainless Steel 3 pointer "Bruce" type anchor.
For: sand - mud.

Code	H mm	L mm	W mm	Kg	UM	€
0107602	190	350	230	2	PCS	
0107605	210	465	315	5	PCS	
0107607	280	530	360	7,5	PCS	
0107610	295	580	410	10	PCS	
0107615	340	655	435	15	PCS	
0107620	350	670	460	20	PCS	
0107630	410	815	560	30	PCS	
0107650	470	980	660	50	PCS	

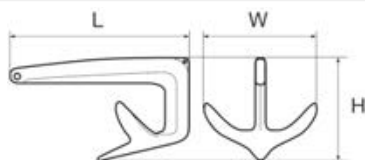

Toro Anchor

Galvanized Steel anchor for soft seabeds such as sand, mud and slime. Thanks to the weight distribution at the tip the anchor immediately finds the optimal penetration angle and guarantees a stable hold.

Code	L mm	W mm	Kg	Motor Boats	Sailing Boats	UM	€
0108704	515	230	4	<6,5 m	<6 m	PCS	
0108706	595	265	6	<8,7 m	<7,8 m	PCS	
0108710	695	310	10	<11,6 m	<10 m	PCS	
0108716	810	360	16	<15 m	<13 m	PCS	
0108720	880	390	20	<16 m	<14,5 m	PCS	
0108725	940	415	25	<18 m	<16 m	PCS	
0108732	1050	435	32	<20 m	<17,5 m	PCS	
0108740	1100	490	40	<21,5 m	<19 m	PCS	
0108750	1175	523	50	<24 m	<23 m	PCS	
0108763	1270	567	63	<25 m	<25 m	PCS	



Toro S/Steel Anchor

Stainless Steel AISI 316 anchor for soft seabeds such as sand, mud and slime. Thanks to the weight distribution at the tip the anchor immediately finds the optimal penetration angle and guarantees a stable hold.

Code	L mm	W mm	Kg	Motor Boats	Sailing Boats	UM	€
0108804	515	230	4	<6,5 m	<6 m	PCS	
0108806	595	265	6	<8,7 m	<7,8 m	PCS	
0108810	695	310	10	<11,6 m	<10 m	PCS	
0108816	810	360	16	<15 m	<13 m	PCS	
0108820	880	390	20	<16 m	<14,5 m	PCS	
0108825	940	415	25	<18 m	<16 m	PCS	
0108832	1050	435	32	<20 m	<17,5 m	PCS	
0108840	1100	490	40	<21,5 m	<19 m	PCS	
0108850	1175	523	50	<24 m	<23 m	PCS	
0108863	1270	567	63	<25 m	<25 m	PCS	

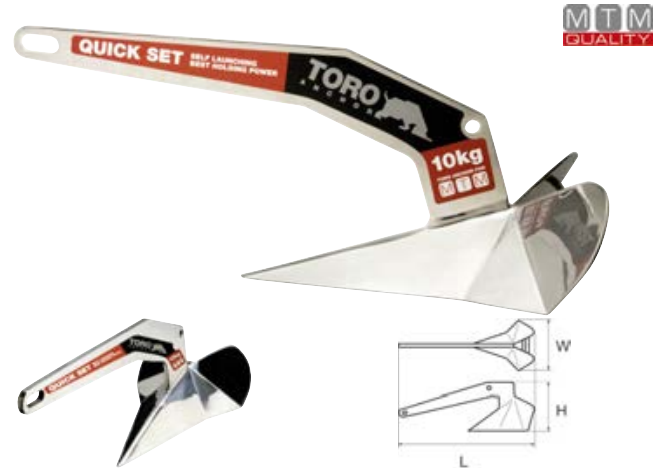

Galvanized Steel Rocna Anchor

Special Galvanized Steel quick grasp Rocna anchor for any type of seabed ideal for any boat size and for megayachts. Both the roll-bar and the weight distribution of the anchor ensure the optimum penetration angle, while the large concave surface gives a safe holding power. R.I.Na. Certificate and heavier 110/150/200/250 Kg anchors available on request.

Code	L mm	W mm	Kg	Boat m	UM	€
0101004	547	275	4	<6 m	PCS	
0101006	630	315	6	<8 m	PCS	
0101010	724	365	10	<11 m	PCS	
0101015	830	415	15	<12 m	PCS	
0101020	864	435	20	<14 m	PCS	
0101025	971	485	25	<16 m	PCS	
0101033	1066	532	33	<20 m	PCS	
0101040	1142	570	40	<22 m	PCS	
0101055	1235	620	55	<26 m	PCS	
0101070	1338	670	70	<30 m	PCS	



Stainless Steel Rocna Anchor

Special Stainless Steel quick grasp Rocna anchor for any type of seabed ideal for any boat size and for megayachts. Both the roll-bar and the weight distribution of the anchor ensure the optimum penetration angle, while the large concave surface gives a safe holding power. R.I.Na. certificate and heavier 110/150/200/250 Kg anchors available on request.

Code	L mm	W mm	Kg	Boat m	UM	€
0101510	724	365	10	<11 m	PCS	
0101515	830	415	15	<12 m	PCS	
0101520	864	435	20	<14 m	PCS	
0101525	971	485	25	<16 m	PCS	
0101533	1066	532	33	<20 m	PCS	
0101540	1142	570	40	<22 m	PCS	
0101555	1235	620	55	<26 m	PCS	
0101570	1338	670	70	<30 m	PCS	



Galvanized Steel Spade Anchor

Very high load resistance special Galvanized Steel Spade anchor with unique concave surface that allows to land the right way up every single time. Centre of mass has been positioned at a very low level in order to prevent the anchor to trip under load or stress. The total weight of the anchor is applied directly onto the sharp tip which grants immediate penetration. Once a load is applied to the rode, the anchor adopts the best position for penetration and its sharp point will easily penetrate the hardest sea beds. The Spade anchor remains buried without cyclic behaviour.

Code	Ref	H mm	L mm	Kg	Boat m	Boat Weight	UM	€
0109110	S60	250	695	9.5	< 7,5 m	< 2 Ton	PCS	
0109115	S80	285	770	15	< 12,5 m	< 6.5 Ton	PCS	
0109120	S100	330	880	20	< 16 m	< 12 Ton	PCS	
0109125	S120	380	960	25	< 18 m	< 16 Ton	PCS	
0109130	S140	370	1050	30	< 20 m	< 20 Ton	PCS	
0109135	S160	420	1120	35	< 23 m	< 23 Ton	PCS	
0109145	S180	425	1180	45	< 23 m	< 26 Ton	PCS	
0109155	S200	500	1200	55	< 25 m	< 30 Ton	PCS	
0109175	SQ240	580	1405	75	< 30 m	< 35 Ton	PCS	



Stainless Steel Spade Anchor

Very high load resistance special Stainless Steel Spade anchor with unique concave surface that allows to land the right way up every single time. Centre of mass has been positioned at a very low level in order to prevent the anchor to trip under load or stress. The total weight of the anchor is applied directly onto the sharp tip which grants immediate penetration. Once a load is applied to the rode, the anchor adopts the best position for penetration and its sharp point will easily penetrate the hardest sea beds. The Spade anchor remains buried without cyclic behaviour.

Code	Ref	H mm	L mm	Kg	Boat m	Boat Weight	UM	€
0109210	X60	250	695	9.5	< 7,5 m	< 2 Ton	PCS	
0109215	X80	285	770	15	< 12,5 m	< 6.5 Ton	PCS	
0109220	X100	330	880	20	< 16 m	< 12 Ton	PCS	
0109225	X120	380	960	25	< 18 m	< 16 Ton	PCS	
0109230	X140	370	1050	30	< 20 m	< 20 Ton	PCS	
0109235	X160	420	1120	35	< 23 m	< 23 Ton	PCS	
0109245	X180	425	1180	45	< 23 m	< 26 Ton	PCS	
0109255	X200	500	1200	55	< 25 m	< 30 Ton	PCS	
0109275	XHR240	580	1405	75	< 30 m	< 35 Ton	PCS	



Vulcan Anchor

Galvanized Steel quick grasp Vulcan anchor for any type of seabed, for small to big powerboats and for yachts. With high resistance fluke geometry shank and snug fit on any type of bow thanks to the omission of the roll-bar. The innovative Roll-Palm ensures anchor landing on the ideal angle of penetration, while the V-bulb extends fluke ballast downward to gain maximum leverage and efficiency, granting more holding power.

Code	L mm	W mm	Kg	Boat m	UM	€
0101206	541	296	6	< 8 m	PCS	
0101209	619	339	9	< 10 m	PCS	
0101212	681	373	12	< 11 m	PCS	
0101215	734	402	15	< 12 m	PCS	
0101220	808	442	20	< 14 m	PCS	
0101225	870	476	25	< 16 m	PCS	
0101233	955	522	33	< 20 m	PCS	
0101240	1018	557	40	< 22 m	PCS	
0101255	1132	619	55	< 26 m	PCS	



Fortress Marine Anchor

Produced in reinforced Aluminum-Magnesium alloy, this anchor weighs less than a third of a Steel anchor, with a 100% better holding power due to its design. Perfect for motorboats, inflatables and used as a secondary anchor on large vessels. Disassembles for easy storage.

The inclination angles for a better grip are:
32° for sand anchoring
45° for soft mud anchoring.

Code	Ref Fortress	Kg	L mm	W mm	Holding Power Kg	Boat m	UM	€
0108003	FX-11	3.0	680	550	1650	< 9,90	PCS	
0108005	FX-16	4.5	780	630	2250	< 11,60	PCS	
0108007	FX-23	6.8	900	730	3600	< 14,60	PCS	
0108010	FX-37	9.5	1000	800	5400	< 15,50	PCS	
0108015	FX-55	14.5	1160	935	7200	< 17,70	PCS	
0108022	FX-85	21.4	1285	1035	9500	< 21,00	PCS	
0108031	FX-125	31.0	1410	1135	12200	< 28,00	PCS	



Calibrated Galvanized Steel Chain

High quality calibrated Hot-dip galvanized Steel chain for windlasses. Minimum breaking load ensured thanks to the strictly controlled production. Bundle: 30, 50, 75 or 100 meters.



Code	D mm	L mm	W mm	Breaking Load Kg	Kg	L meters	UM	€
011000630	6	18,5	8	2000	24	30	PCK	
011000650	6	18,5	8	2000	40	50	PCK	
011000675	6	18,5	8	2000	60	75	PCK	
0110006100	6	18,5	8	2000	80	100	PCK	
011000730	7	22	9	3000	33	30	PCK	
011000750	7	22	9	3000	55	50	PCK	
011000775	7	22	9	3000	82,5	75	PCK	
0110007100	7	22	9	3000	110	100	PCK	
011000830	8	24	10	4000	43,5	30	PCK	
011000850	8	24	10	4000	72,5	50	PCK	
011000875	8	24	10	4000	108,75	75	PCK	
0110008100	8	24	10	4000	145	100	PCK	
011001030	10	28	14	6500	72	30	PCK	
011001050	10	28	14	6500	120	50	PCK	
011001075	10	28	14	6500	180	75	PCK	
0110010100	10	28	14	6500	240	100	PCK	
011001130	10	30	15	6500	69	30	PCK	
011001150	10	30	15	6500	115	50	PCK	
011001175	10	30	15	6500	172,5	75	PCK	
0110011100	10	30	15	6500	230	100	PCK	
011001250	12	36	16	9000	165	50	PCK	
011001275	12	36	16	9000	247,5	75	PCK	
0110012100	12	36	16	9000	330	100	PCK	
011001375	13	36	18	11000	300	75	PCK	
0110013100	13	36	18	11000	400	100	PCK	
011001675	16	45	22	17000	442,5	75	PCK	
0110016100	16	45	22	17000	590	100	PCK	



Calibrated G70 Galvanized Steel Chain

High resistance calibrated G70 superior quality Hot-dip galvanized Steel chain for windlasses. Minimum breaking load ensured thanks to the strictly controlled production. Bundle: 30, 50, 75 or 100 meters.



Code	D mm	L mm	W mm	Breaking Load Kg	Kg	L meters	UM	€
011070830	8	24	10	6800	43,5	30	PCK	
011070850	8	24	10	6800	72,5	50	PCK	
011070875	8	24	10	6800	108,75	75	PCK	
0110708100	8	24	10	6800	145	100	PCK	
011071050	10	28	14	9800	120	50	PCK	
011071075	10	28	14	9800	180	75	PCK	
0110710100	10	28	14	9800	240	100	PCK	
011071150	10	30	15	9800	115	50	PCK	
011071175	10	30	15	9800	172,50	75	PCK	
0110711100	10	30	15	9800	230	100	PCK	
011071250	12	36	16	14400	165	50	PCK	
011071275	12	36	16	14400	247,50	75	PCK	
0110712100	12	36	16	14400	330	100	PCK	



Calibrated Stainless Steel Chain

Controlled breaking load high quality calibrated 316 Stainless Steel chain. Bundle: 30, 50, 75 or 100 meters.



Code	D mm	L mm	W mm	Breaking Load Kg	Kg	L meters	UM	€
011500615	6	18,5	8	1600	11,3	15	PCK	
011500630	6	18,5	8	1600	22,5	30	PCK	
011500650	6	18,5	8	1600	37,5	50	PCK	
011500675	6	18,5	8	1600	56,25	75	PCK	
011500715	7	22	9	2500	15,8	15	PCK	
011500730	7	22	9	2500	31,5	30	PCK	
011500750	7	22	9	2500	52,5	50	PCK	
011500775	7	22	9	2500	78,8	75	PCK	
011500815	8	24	10	3200	21	15	PCK	
011500830	8	24	10	3200	42	30	PCK	
011500850	8	24	10	3200	70	50	PCK	
011500875	8	24	10	3200	105	75	PCK	
0115008100	8	24	10	3200	140	100	PCK	
011501015	10	28	14	5000	34,5	15	PCK	
011501030	10	28	14	5000	69	30	PCK	
011501050	10	28	14	5000	115	50	PCK	
011501075	10	28	14	5000	172,5	75	PCK	
0115010100	10	28	14	5000	230	100	PCK	
011501115	10	30	15	5000	33,8	15	PCK	
011501130	10	30	15	5000	67,5	30	PCK	
011501150	10	30	15	5000	112,5	50	PCK	
011501175	10	30	15	5000	168,8	75	PCK	
0115011100	10	30	15	5000	225	100	PCK	
011501250	12	36	16	7240	160	50	PCK	
0115012100	12	36	16	7240	320	100	PCK	
011501350	13	36	18	8000	195	50	PCK	
0115013100	13	36	18	8000	390	100	PCK	



- LONG CHAINS -

Long Link Galvanized Steel Chain

Controlled high quality long link Hot-dip galvanized Steel chain. Bundle: 50 meters.



Code	D mm	L mm	W mm	Breaking Load Kg	Kg	L meters	UM	€
011100650	6	23	11	1650	37,5	50	PCK	
011100850	8	32,3	14	3200	67,5	50	PCK	
011101050	10	40	17	5000	110	50	PCK	
011101250	12	49	22	7000	155	50	PCK	
011101450	14	56	22	9200	205	50	PCK	
011101650	16	56	23	12500	295	50	PCK	
011101850	18	63,5	28,1	16000	335	50	PCK	
011102250	22	80,1	34,2	20000	430	50	PCK	
011102850	28	98,8	41,9	36000	845	50	PCK	
011103050	30	105	46,4	41500	910	50	PCK	

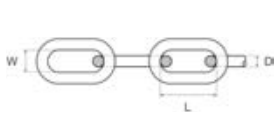
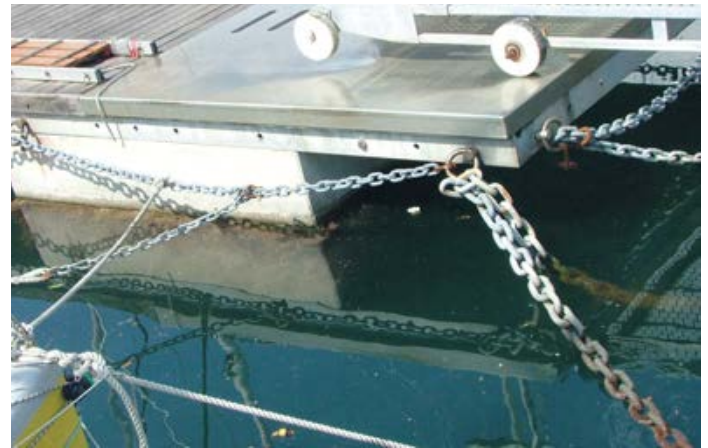

Long Link Stainless Steel Chain

Long link 316 Stainless Steel chain in 50 and 25 meters bundle.



Code	D mm	L mm	W mm	Kg	L meters	UM	€
011520250	2	22,1	6	3	50	PCK	
011520350	3	26	6,1	4,5	50	PCK	
011520425	4	32,2	7,6	6,75	25	PCK	
011520525	5	35	10	10,75	25	PCK	

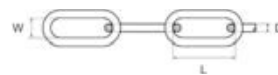

Stainless Steel Long Link Chain Segments

High quality Stainless Steel long link chain segments.



Code	D mm	L meters	UM	€
011520602	6	2	PCS	
011520605	6	5	PCS	
011520802	8	2	PCS	
011520805	8	5	PCS	
011521002	10	2	PCS	
011521005	10	5	PCS	
011521202	12	2	PCS	
011521205	12	5	PCS	



Galvanized Steel Chain Segments

High quality Hot-dip galvanized Steel long link chain segments.



Code	D mm	L meters	UM	€
011100602	6	2	PCS	
011100605	6	5	PCS	
011100802	8	2	PCS	
011100805	8	5	PCS	
011101002	10	2	PCS	
011101005	10	5	PCS	
011101202	12	2	PCS	
011101205	12	5	PCS	



Mooring System Kit 1

Anchor Rope/Chain kit, including 30 m line, complete with thimble, 2 m Hot-dip galvanized Steel chain and 2 shackles.

Code	30 Meters Line	2 Meters Chain	Shackles	Weight Kg	UM	€
3104108	ø 8 mm	ø 6 mm	2	3,2	PCK	
3104110	ø 10 mm	ø 8 mm	2	4,4	PCK	



Anchor L Braid/Chain System

Braid/chain ready-to-use anchor system with perfect shaped splicing. DIN766-G40 Galvanized Steel calibrated chain and 16-plait high-tenacity Polyester braid resistant to abrasion.

It can be easily raised by hand or turned in the gypsy.

Code	Braid	Chain	UM	€
3104164	12,6 mm x 40 m	6 mm x 10 m	PCK	
3104165	12,6 mm x 50 m	8 mm x 7,5 m	PCK	
3104166	14,2 mm x 50 m	8 mm x 7,5 m	PCK	



Anchor L Line/Chain System

Line/chain ready-to-use anchor system with perfect shaped splicing. DIN766-G40 Galvanized Steel calibrated chain and 3-strand high-tenacity Polyester rope resistant to abrasion.

It can be easily raised by hand or turned in the gypsy.

Code	Line	Chain	UM	€
3104174	12,6 mm x 40 m	6 mm x 10 m	PCK	
3104175	12,6 mm x 50 m	8 mm x 7,5 m	PCK	
3104176	14,2 mm x 50 m	8 mm x 7,5 m	PCK	

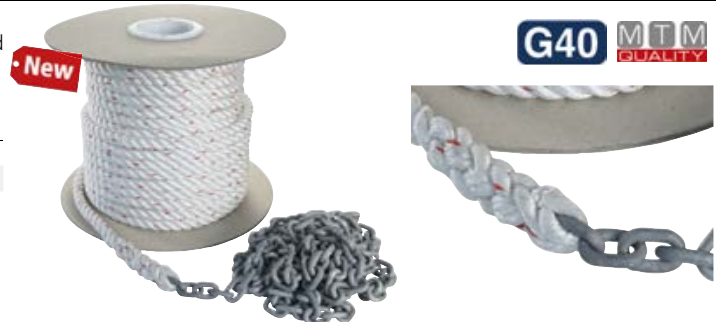

Anchor L Braid/Stainless Steel Chain System

Line/chain ready-to-use anchor system with perfect shaped splicing. 316 Stainless Steel calibrated chain and 3-strand high-tenacity Polyester rope resistant to abrasion.

It can be easily raised by hand or turned in the gypsy.

Code	Line	Chain	UM	€
3104184	12,6 mm x 40 m	6 mm x 10 m	PCK	
3104185	12,6 mm x 50 m	8 mm x 7,5 m	PCK	
3104186	14,2 mm x 50 m	8 mm x 7,5 m	PCK	



Swivel Anchor Connector

Stainless Steel swivel connector. It slides smoothly over anchor rollers, while preventing chain snagging.

Code	For Chain D mm	A mm	B mm	C mm	D mm	D1 mm	L mm	UM	€
0123008	6/8	10	15	22	7	10	92	PCS	
0123012	10/12	13	22	28	11	11	120	PCS	
0123013	12/14	18	28	32	14	16	140	PCS	

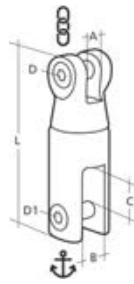

Double Swivel Anchor Connector

Stainless Steel double swivel connector. It slides smoothly over anchor rollers, while preventing chain snagging. It allows to set the anchor properly in the bow roller.

Code	For Chain D mm	A mm	B mm	C mm	D mm	D1 mm	L mm	UM	€
0133418	6/8	10	15	20	7	9	120	PCS	
0133422	10	13	18	28	10	10	160	PCS	

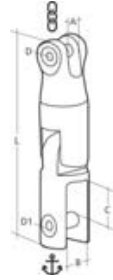

TrimFix Anchor Connector

Stainless Steel TrimFix long swivel anchor connector. It runs in the bow anchor without stalling, prevents chain tangling. It allows to perfectly pull and store anchors into the bow rollers.

Code	For Chain D mm	A mm	B mm	D mm	L mm	UM	€
0133438	6/8	10	11 x 21	8	225	PCS	
0133440	10/12	14	14 x 27	12	310	PCS	

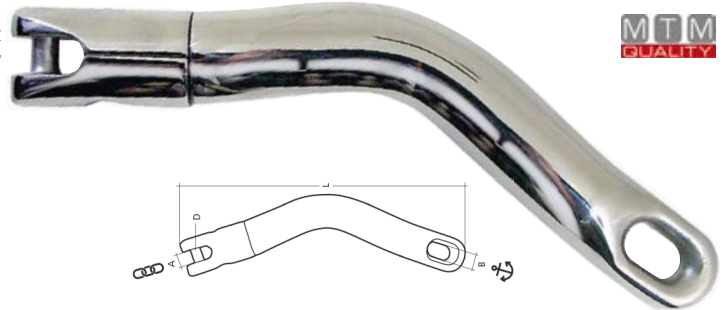

Douglas Swivel Anchor Connector

Stainless Steel Douglas swivel connector. It slides smoothly over anchor rollers, while preventing chain snagging. With pin safety lock.

0123308 breaking load 2800 kg.

0123312 breaking load 6800 kg.

Code	For Chain D mm	A mm	B mm	C mm	D mm	D1 mm	L mm	UM	€
0123308	6/8	10	16	20	8	10	90	PCS	
0123312	10/12	13	22	27	12	12	115	PCS	



Douglas Harrier

HD Douglas Swivel Anchor Connector

Stainless Steel Douglas reinforced swivel connector. It slides smoothly over anchor rollers, while preventing chain snagging. With pin safety lock and reinforced anti-twist fork.

0123309 for 7 to 17 Kg anchors.

0123313 for 30 to 50 Kg anchors.

Code	For Chain D mm	BL Kg	A mm	B mm	C mm	D mm	D1 mm	L mm	UM	€
0123309	6/8	8500	9	15	30	8	10	92	PCS	
0123313	10/12	12000	15	27	37	12	13	122	PCS	

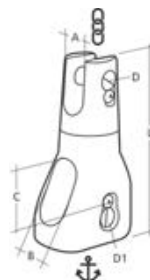

Douglas Harrier

Trimmer H.D. Anchor Connector

Douglas type Stainless Steel anchor double-swivel head and fork connector. It runs in the bow anchor without stalling, prevents chain tangling. It allows to perfectly pull and store anchors into the bow rollers. No extra shackles needed to connect the anchors.

0133428 for anchors from 7 to 16 Kg

0133432 for anchors from 20 to 30 Kg

0133433 for anchors from 30 to 50 Kg

Code	For Chain D mm	BL Kg	A mm	B mm	C mm	D mm	D1 mm	L mm	UM	€
0133428	6/8	3200	10	16	27	8	10	200	PCS	
0133432	10/12	8500	16	22	32	12	13	240	PCS	
0133433	10/12	12000	16	27	36	12	15	250	PCS	

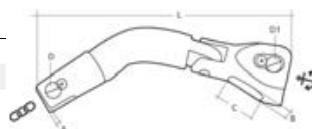

Douglas Harrier

AllenHead Shackle

Stainless Steel allenhead shackle. Used as junction between chain and anchor. The non captive pin allows easy sliding thru the bow roller.

Code	D mm	L mm	W mm	UM	€
0122706	6	20	12	PCS	
0122708	8	28	16	PCS	
0122710	10	35	20	PCS	
0122712	12	42	24	PCS	

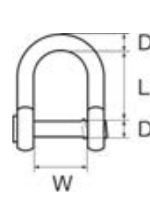

Stainless Steel Connecting Links

Stainless Steel connecting links for any chain segment connection.

Code	D mm	L mm	W mm	UM	€
0112906	6	20	10	PCS	
0112908	8	24	12	PCS	
0112910	10	28	14	PCS	
0112912	12	36	18	PCS	



8P Stainless Steel Connecting Links

High breaking load 8-pin Stainless Steel connecting links. For calibrated chains.

Code	D mm	L mm	W mm	UM	€
0112926	6	20	9	PCS	
0112928	8	24	12	PCS	
0112930	10	28	14	PCS	
0112932	12	36	18	PCS	



Sea Marker Chain Marker

Shockproof polymer chain markers specially designed for marine use. Used to mark the various lengths of the chain. Simple assembly with interlocking system: once inserted into the link they no longer fall out. Pack of 50 pieces, 10 pieces for each of the 5 colours.

Code	For Chain ø mm	Pcs	UM	€
0112870	6	50	PCK	
0112871	8	50	PCK	
0112872	10	50	PCK	
0112873	12/13	50	PCK	



Chain Marker

Coloured plastic markers. To be set onto the links, to display the exact length of the chain laid.

Code	For Chain ø mm	Colour	Pcs	UM	€
0112856BL	6	BLUE	14	PCK	
0112856GN	6	GREEN	14	PCK	
0112856RD	6	RED	14	PCK	
0112856WH	6	WHITE	14	PCK	
0112856YE	6	YELLOW	14	PCK	
0112858BL	8	BLUE	10	PCK	
0112858GN	8	GREEN	10	PCK	
0112858RD	8	RED	10	PCK	
0112858WH	8	WHITE	10	PCK	
0112858YE	8	YELLOW	10	PCK	
0112860BL	10	BLUE	8	PCK	
0112860GN	10	GREEN	8	PCK	
0112860RD	10	RED	8	PCK	
0112860WH	10	WHITE	8	PCK	



Code	For Chain ø mm	Colour	Pcs	UM	€
0112860YE	10	YELLOW	8	PCK	
0112862BL	12	BLUE	6	PCK	
0112862GN	12	GREEN	6	PCK	
0112862RD	12	RED	6	PCK	
0112862WH	12	WHITE	6	PCK	
0112862YE	12	YELLOW	6	PCK	

Hook Anchor Saver

Galvanized Carbon Steel hook anchor saver. Perfect to retrieve blocked anchors, releasing them from twisted lines or chains.

Code	UM	€
0133602	PCS	



S/Steel Hook Anchor Saver

Mirror polished Stainless Steel hook anchor saver. Perfect to retrieve blocked anchors, releasing them from twisted lines or chains.

Code	UM	€
0133603	PCS	



Stainless Steel Chain Lock

Stainless Steel anchor chain stopper preserves from shocks and bumps the windlass while anchoring, eliminating the transmission of annoying vibrations of the rolling anchored boat. It avoids the chain from stepping over the gypsy.

Code	For Chain ø mm	UM	€
0133518	6/8	PCS	
0133520	10/12	PCS	

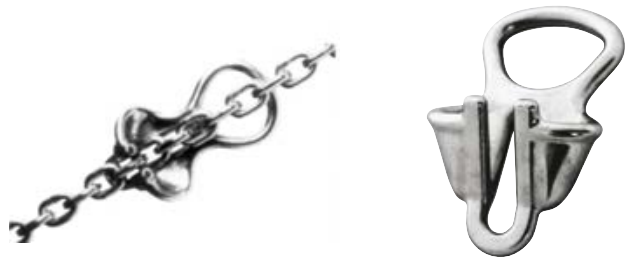

Stainless Steel Chain Stopper

Stainless Steel chain stopper which keeps anchor and chain stopped when weighed. It takes tension off the windlass extending his life, allows also to weigh another anchor or to use the windlass as a capstan.

Code	For Chain mm	UM	€
1136006	6/8	PCS	
1136010	8/10	PCS	



Deck Pipe L type

Chromed Brass deck pipe.

Code	For Chain mm	Overall ø mm	Inner Dia ø mm	UM	€
1135502	6	155	125	PCS	



Stainless Steel Chain Boy

Stainless Steel Chain Boy chain distributor. To be installed in the chain peak box, it lays the chain properly without tangling. Endowed with 50-75-100 mm sections to build different modular (325-375-400-425-450-475 mm) height. (325 mm is the minimum base height).

Code	UM	€
1135520	PCS	



D Shackle

Galvanized Steel Dee shackle.

Code	D mm	L mm	W mm	UM	€
0123506	6	25	13	PCS	
0123508	8	32	16	PCS	
0123510	10	38	19	PCS	
0123512	12	49	24	PCS	
0123514	14	53	28	PCS	
0123516	16	61	33	PCS	
0123520	20	72	38	PCS	
0123522	22	92	43	PCS	
0123525	25	97	51	PCS	
0123528	28	120	57	PCS	

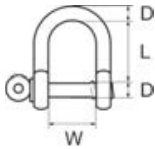
**Bow Shackle**

Galvanized Steel Bow shackle.

Code	D mm	L mm	W mm	UM	€
0123406	6	27	13	PCS	
0123408	8	30	16	PCS	
0123410	10	38	19	PCS	
0123412	12	51	24	PCS	
0123414	14	60	28	PCS	
0123416	16	67	33	PCS	
0123420	20	78	38	PCS	
0123422	22	96	42	PCS	
0123425	25	109	47	PCS	
0123428	28	120	57	PCS	

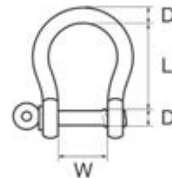
**Yellow Pin H.Duty D Shackle**

Forged Hot-dip galvanized Steel Dee shackle, safe even with high loads. CE EN13889:2003+A1:2008 certified with working load stamped on the shackle. Note: the breaking load is approximately 6 times the working load.

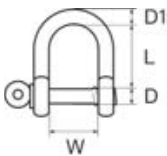

Code	D Pin mm	D1 mm	Working Load Kg	UM	€
0123806	8	6	500	PCS	
0123808	10	8	750	PCS	
0123810	11	10	1000	PCS	
0123812	13	11	1500	PCS	
0123814	16	13	2000	PCS	
0123816	19	16	3250	PCS	
0123820	22	19	4750	PCS	
0123822	25	22	6500	PCS	
0123825	29	25	8500	PCS	
0123830	32	29	9500	PCS	
0123832	35	32	12000	PCS	

**Yellow Pin H.Duty Bow Shackle**

Forged Hot-dip galvanized Steel Bow shackle, safe even with high loads. CE EN13889:2003+A1:2008 certified with working load stamped on the shackle. Note: the breaking load is approximately 6 times the working load.

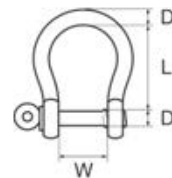

Code	D Pin mm	D1 mm	Working Load Kg	UM	€
0123706	8	6	500	PCS	
0123708	10	8	750	PCS	
0123710	11	10	1000	PCS	
0123712	13	11	1500	PCS	
0123714	16	13	2000	PCS	
0123716	19	16	3250	PCS	
0123720	22	19	4750	PCS	
0123722	25	22	6500	PCS	
0123725	29	25	8500	PCS	
0123730	32	29	9500	PCS	
0123732	35	32	12000	PCS	

**D Shackle**

Stainless Steel Dee shackle.

Code	D mm	L mm	W mm	UM	€
0120004	4	16	8	PCS	
0120005	5	20	10	PCS	
0120006	6	24	12	PCS	
0120008	8	32	16	PCS	
0120010	10	40	20	PCS	
0120012	12	48	24	PCS	
0120014	14	56	28	PCS	
0120016	16	64	32	PCS	

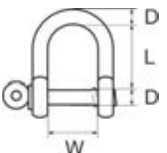
**Bow Shackle**

Stainless Steel Bow shackle.

Code	D mm	L mm	W mm	UM	€
0120505	5	16	9	PCS	
0120506	6	21	12	PCS	
0120508	8	27	16	PCS	
0120510	10	33	20	PCS	
0120512	12	40	24	PCS	
0120514	14	51	27	PCS	
0120516	16	60	32	PCS	

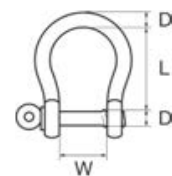

Galvanized Steel Eye-Eye Swivel

Galvanized Steel Eye-Eye swivel.

Code	D mm	L mm	W mm	UM	€
0122711	10	117	25	PCS	
0122713	13	154	32	PCS	
0122716	16	192	39	PCS	
0122719	19	231	41	PCS	

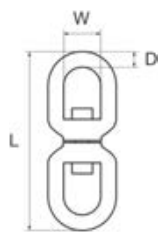
**Galvanized Steel Eye-Jaw Swivel**

Galvanized Steel Eye-Jaw swivel.

Code	D mm	L mm	W mm	UM	€
0122910	10	118	19	PCS	
0122913	13	152	22	PCS	
0122916	16	193	32	PCS	
0122919	19	235	38	PCS	

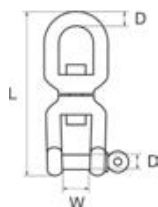
**Galvanized Steel Jaw-Jaw Swivel**

Galvanized Steel Jaw-Jaw swivel.

Code	D mm	L mm	W mm	UM	€
0122810	10	118	19	PCS	
0122813	13	152	22	PCS	
0122816	16	192	32	PCS	
0122819	19	235	36	PCS	

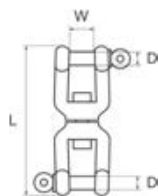
**Stainless Steel Eye-Eye Swivel**

Stainless Steel Eye-Eye swivel.

Code	D mm	L mm	W mm	UM	€
0121705	5	60	13	PCS	
0121706	6	65	15	PCS	
0121708	8	94	20	PCS	
0121710	10	118	23	PCS	
0121713	13	154	32	PCS	

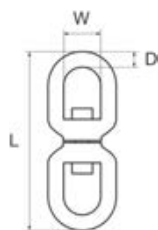
**Stainless Steel Eye-Jaw Swivel**

Stainless Steel Eye-Jaw swivel.

Code	D mm	L mm	W mm	UM	€
0121905	5	60	11	PCS	
0121906	6	67	12	PCS	
0121908	8	98	15	PCS	
0121910	10	118	18	PCS	
0121913	13	152	26	PCS	

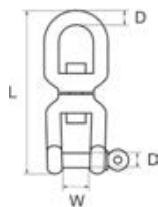
**Stainless Steel Jaw-Jaw Swivel**

Stainless Steel Jaw-Jaw swivel.

Code	D mm	L mm	W mm	UM	€
0121805	5	60	11	PCS	
0121806	6	66	12	PCS	
0121808	8	94	15	PCS	
0121810	10	118	18	PCS	
0121813	13	154	26	PCS	

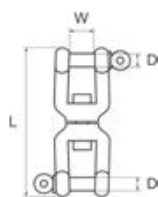

Standard Carabiner

316 Stainless Steel Standard Carabiner.

Code	D mm	L mm	A mm	UM	€
0211150	5	50	8	PCS	
0211160	6	60	9	PCS	
0211170	7	70	9	PCS	
0211180	8	80	10	PCS	
0211110	10	100	12	PCS	
0211112	11	120	16	PCS	
0211114	12	140	20	PCS	
0211116	13	160	26	PCS	

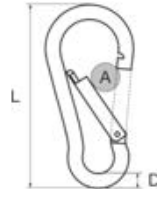
**Standard Eye Carabiner**

316 Stainless Steel Standard Carabiner with eye.

Code	D mm	L mm	A mm	O mm	UM	€
0211350	5	50	8	7.5	PCS	
0211360	6	60	9	9	PCS	
0211370	7	70	9	10	PCS	
0211380	8	80	10	11.5	PCS	
0211310	10	100	12	14	PCS	
0211312	11	120	16	16.5	PCS	
0211314	12	140	20	18	PCS	
0211316	13	160	26	20	PCS	

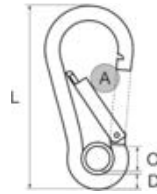
**Side Carabiner**

316 Stainless Steel side wide opening carabiner. It prevents ropes from tangling.

Code	D mm	L mm	A mm	UM	€
0211791	8	80	22	PCS	
0211792	10	100	24	PCS	
0211793	11	120	26	PCS	

**Wide Carabiner**

316 Stainless Steel wide opening carabiner.

Code	D mm	L mm	A mm	UM	€
0211891	8	85	18	PCS	
0211892	10	100	19	PCS	
0211893	11	125	26	PCS	

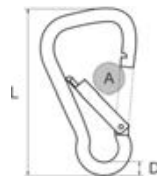
**Wide Lock Carabiner**

316 Stainless Steel wide opening screw lock carabiner.

Code	D mm	L mm	A mm	UM	€
0211860	6	60	10	PCS	
0211880	8	80	14	PCS	
0211810	10	100	20	PCS	
0211812	11	120	24	PCS	

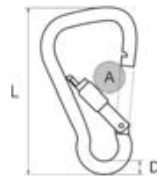
**Eye Wide Lock Carabiner**

316 Stainless Steel wide opening screw lock carabiner with eye.

Code	D mm	L mm	A mm	O mm	UM	€
0212060	6	60	10	9	PCS	
0212080	8	80	14	11	PCS	
0212010	10	100	20	14	PCS	
0212012	11	120	24	18	PCS	

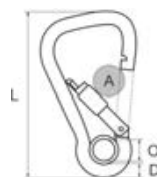

U-Bolt Pt

Stainless Steel pinched wire U-Bolts.

Code	D mm	M mm	L mm	W mm	H mm	UM	€
0230004	4	4	64	30	30	PCS	
0230005	5	5	80	35	40	PCS	
0230006	6	6	90	35	40	PCS	
0230008	8	8	100	35	50	PCS	
0230010	10	10	130	50	55	PCS	
0230012	12	12	150	60	65	PCS	

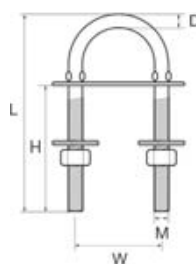
**U-Bolt S**

Stainless Steel thickened wire U-Bolt.

Code	D mm	M mm	L mm	W mm	H mm	UM	€
0230105	6	5	78	36	48	PCS	
0230106	8	6	90	36	42	PCS	
0230108	10	8	100	45	52	PCS	
0230110	12	10	135	50	80	PCS	
0230112	14	12	150	60	85	PCS	

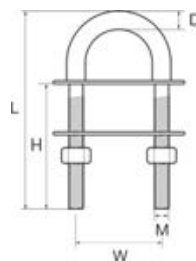
**U-Bolt G**

Stainless Steel thickened wire U-Bolt with easy tightening self-gripping nuts.

Code	D mm	M mm	L mm	W mm	UM	€
0230118	10	8	100	40	PCS	
0230120	12	10	100	40	PCS	
0230122	14	12	120	50	PCS	

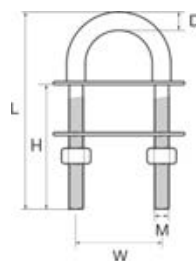
**Wtight U-Bolt**

Mirror polished Stainless Steel U-Bolt with welded watertight blocking base.

Code	D mm	M"	L mm	W mm	H mm	UM	€
0230410	9,5	3/8	100	36	63	PCS	
0230412	12,7	1/2	140	46	113	PCS	

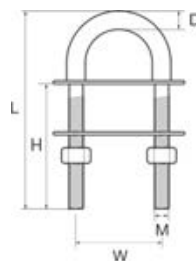
**Welded Eye Bolt**

Stainless Steel welded eye bolts.

Code	M mm	H mm	W mm	D mm	UM	€
0231040	6	40	13	6	PCS	
0231060	6	60	13	6	PCS	
0231180	8	70	17	8	PCS	
0231110	10	90	21	10	PCS	
0231112	12	105	25	12	PCS	

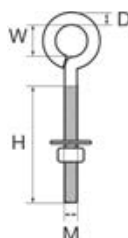
**Double Eye Eye Bolt**

Stainless Steel double eye bolt.

Code	M mm	H mm	W mm	D mm	UM	€
0233050	8	65	20	7	PCS	
0233080	10	85	25	8	PCS	

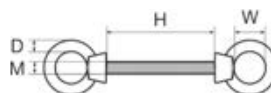

Ring Bolt

Stainless Steel ring on threaded bolt.

Code	M mm	H mm	W mm	D mm	UM	€
0232008	8	75	45	8	PCS	
0232010	10	65	50	9	PCS	
0232012	12	80	60	12	PCS	

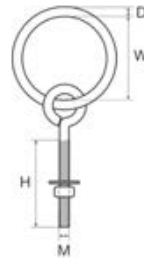
**Dock Edge Eze Docker Mooring Ring**

Galvanized Steel portable and removable robust mooring ring for docks and pontoons. Quick and handy, it can be easily fixed by inserting the T between dock planks or in other tight spaces.

Code	H mm	Max Hooking Thickness mm	UM	€
1100740	150	100	PCS	

**Dock Edge Flip-Up Cleat**

Marine grade Almag 35 powder coated white Aluminum foldable cleat for docks, pontoons and fishing boats. 2 or 3 mounting holes base.

Code	L mm	H mm	UM	€
1100760	165	20	PCS	
1100761	216	30	PCS	

**Dock Edge Classic Cleat**

Marine grade Almag 35 powder coated white Aluminum cleat for docks, pontoons and fishing boats. 4 mounting holes base.

Code	L mm	H mm	UM	€
1100750	165	50	PCS	
1100751	216	60	PCS	

**Single Bollard**

Galvanized Steel crossed single mooring bollard for pontoons and fishing boats. Base with 4 mounting holes diameter 6/8 mm.

Code	Base mm	H mm	UM	€
1100712	110 x 60	90	PCS	
1100714	140 x 80	110	PCS	

**Double Bollard**

Galvanized Steel crossed double mooring bollard for pontoons and fishing boats. 6 mounting holes base.

Code	L mm	H mm	UM	€
1100720	200	70	PCS	
1100724	260	95	PCS	



Classic Double Shaft Bollard

Chromed Brass double shaft classic mooring bollard cleat. 2 hidden metric stud holes base.

Code	L mm	Wheelbase mm	Stud Holes ø	UM	€
1101010	100	45	M6	PCS	
1101013	140	63	M8	PCS	
1101017	175	90	M10	PCS	
1101020	200	106	M12	PCS	

**Classic Mooring Bollards**

Polished Bronze classic angled shaft mooring bollards. 2 hidden metric stud holes base.

Code	L mm	UM	€
1102010	100	PCS	
1102013	140	PCS	
1102017	175	PCS	
1102020	200	PCS	

**New Classic Double Shaft Bollard**

Chromed Brass double shaft mooring bollard cleat. 2 hidden metric stud holes base.

Code	L mm	Wheelbase mm	Stud Holes ø	UM	€
1101216	160	88	M10	PCS	
1101220	200	105	M12	PCS	
1101225	250	136	M14	PCS	

**Wooden Ledge Cleat**

Chromed Brass double shaft wooden ledge cleat. 2 hidden metric stud holes narrow base.

Code	L mm	Wheelbase mm	Stud Holes ø	UM	€
1101413	220	88	M8	PCS	
1101417	260	109	M8	PCS	
1101421	320	141	M10	PCS	

**Pop-Up Chromed Bronze Cleat**

Pop-Up Chromed Brass mooring cleat. The bollard appears and disappears with a single hand's press. Recessed cylinder wheelbase 55 mm, recessed frame dimensions 195 x 50 mm.

Code	L mm	UM	€
1114515	150	PCS	

**Chromed Bronze Skene Choks (R+L)**

Paired (right and left) Chromed Brass skene choks. 2 mounting holes base.

Code	mm	Max Line ø mm	Wheelbase mm	UM	€
1130011	110 x 27	14	86	PR	
1130015	150 x 34	16	124	PR	
1130020	200 x 40	20	167	PR	
1130025	250 x 45	24	208	PR	
1130030	300 x 55	30	120	PR	



Smooth Cleat

Flat anvil shaped Anodized Aluminum cleat. 4 mounting holes hollow base.

Code	L mm	Wheelbase mm	UM	€
1112815	150	33	PCS	
1112820	200	51	PCS	
1112825	250	67	PCS	

**Low Cleat**

Low profile flat anvil shaped Anodized Aluminum cleat. 2 through mounting holes narrow base. It can be mounted in tight space.

Code	L mm	Wheelbase mm	UM	€
1111616	160	37	PCS	
1111622	220	43	PCS	

**Closed Base Cleat**

Compact and elegant flat anvil shaped HS Anodized Aluminum cleat. Used on sailboats or when there is little space at the sides. 2 through mounting holes narrow base.

Code	L mm	Wheelbase mm	UM	€
1111650	80	20	PCS	
1111651	100	26	PCS	
1111652	125	32	PCS	
1111653	150	38	PCS	
1111654	200	52	PCS	
1111655	250	60	PCS	

**Classic Yacht Cleat**

Outstanding quality and finishing flat anvil shaped HS Anodized Aluminum cleat. 4 mounting holes hollow base.

Code	L mm	Wheelbase mm	UM	€
1111812	125	39	PCS	
1111816	160	44	PCS	
1111822	210	59	PCS	
1111828	260	70	PCS	
1111835	320	88	PCS	

**Edge Double Shaft Bollard**

Classic double shaft Anodized Aluminum cleat. 6 Screw holes base.

Code	L mm	UM	€
1112217	160	PCS	
1112221	200	PCS	
1112226	250	PCS	

**New Double Shaft Bollard**

Outstanding quality and finishing classic double shaft Anodized Aluminum cleat. 2 hidden metric stud holes base.

Code	L mm	Wheelbase mm	Stud Holes ø	UM	€
1111213	130	75	M6	PCS	
1111216	160	82	M8	PCS	
1111223	230	118	M10	PCS	
1111233	330	159	M14	PCS	



Anodized Aluminum Skene Choks (R+L)

Paired (right and left) Anodized Aluminum skene choks. 2 mounting holes base.

Code	mm	Max Line ø mm	Wheelbase mm	UM	€
1132014	140 x 30	16	110	PR	
1132015	170 x 32	20	137	PR	
1132021	200 x 40	24	175	PR	
1132026	260 x 50	36	210	PR	



Anodized Aluminum Straight Chocks

Anodized Aluminum in line chocks.

Code	mm	Max Line ø mm	Wheelbase mm	UM	€
1132514	140 x 25	14	115	PCS	
1132515	160 x 30	16	146	PCS	
1132521	200 x 40	22	174	PCS	
1132526	260 x 50	32	204	PCS	



Anodized Aluminum Edge Straight Chocks

Anodized Aluminum in line chocks.

Code	mm	UM	€
1132534	140	PCS	
1132537	170	PCS	
1132541	210	PCS	



- PLASTIC MOORING CLEATS -

Black Plastic Flat Mooring Cleat

Flat anvil shaped Black Plastic mooring cleat. 2 through mounting holes narrow base.

Code	L mm	Wheelbase mm	UM	€
1111406	60	20	PCS	
1111408	80	21	PCS	
1111411	110	28	PCS	
1111414	145	34	PCS	
1111418	180	44	PCS	
1111422	220	53	PCS	



White Plastic Flat Mooring Cleat

Flat anvil shaped White Plastic mooring cleat. 2 through mounting holes narrow base.

Code	L mm	Wheelbase mm	UM	€
1111506	60	20	PCS	
1111508	80	21	PCS	
1111511	110	28	PCS	
1111514	145	34	PCS	
1111518	180	44	PCS	
1111522	220	53	PCS	



Plastic Jam Mooring Cleat

Ultra flat anvil shaped Black Plastic mooring jam cleat. 2 through mounting holes narrow base.

Code	L mm	Wheelbase mm	UM	€
1111415	155	30	PCS	



Hollow Cleat

316 Stainless Steel mirror polished round rod shaped cleat. 4 mounting holes hollow base.

Code	L mm	Wheelbase mm	UM	€
1112012	125	54	PCS	
1112015	150	57	PCS	
1112020	200	71	PCS	
1112025	250	93	PCS	
1112030	300	99	PCS	

**Silhouette Cleat**

316 Stainless Steel mirror polished flat anvil shaped cleat. 4 mounting holes hollow base.

Code	L mm	Wheelbase mm	UM	€
1112412	125	40	PCS	
1112415	150	52	PCS	
1112420	200	57	PCS	
1112425	250	54	PCS	

**Thin Cleat**

316 Stainless Steel flat shaped mirror polished cleat. 2 through mounting holes narrow base. It can be mounted in tight spaces.

Code	L mm	Wheelbase mm	UM	€
1112510	100	30	PCS	
1112512	125	41	PCS	
1112515	150	45	PCS	
1112520	200	55	PCS	
1112525	250	70	PCS	

**Dune Cleat**

316 Stainless Steel flat anvil shaped mirror polished cleat. 2 hidden metric stud holes hollow base.

Code	L mm	Wheelbase mm	Stud Holes ø	UM	€
1112915	150	45	M6	PCS	
1112920	200	59	M8	PCS	
1112925	250	75	M10	PCS	

**Silver Gate cleat**

316 Stainless Steel mirror polished gate shaped cleat. 2 hidden metric stud holes hollow base.

Code	L mm	Wheelbase mm	Stud Holes ø	UM	€
1113103	160	53	M8	PCS	
1113104	200	65	M8	PCS	
1113105	250	80	M10	PCS	

**Skandia Cleat**

316 Stainless Steel flat anvil shaped mirror polished cleat. 2 hidden metric stud holes narrow base. It can be mounted in tight spaces.

Code	L mm	Wheelbase mm	Stud Holes ø	UM	€
1112615	150	48	M8	PCS	
1112620	205	69	M8	PCS	
1112626	265	82	M10	PCS	
1112631	310	79	M14	PCS	

**Double Shaft Bollard**

316 Stainless Steel mirror polished double shaft bollard. 2 hidden metric stud holes base.

Code	Base L mm	L mm	Wheelbase mm	Stud Holes ø	UM	€
1111020	200	220	100	M10	PCS	
1111024	200	240	100	M10	PCS	
1111030	250	300	130	M12	PCS	
1111035	310	340	165	M18	PCS	



Bow Post

316 Stainless Steel through pin square bow cleat. 4 mounting holes base.

Code	Base mm	H mm	UM	€
1112710	92 x 92	95	PCS	
1112715	97 x 122	120	PCS	
1112720	118 x 140	142	PCS	

**Foldable Stainless Steel Cleat**

Foldable polished Stainless Steel mooring cleat. Does not require recess hole, can be lowered by folding it.

Code	L mm	W mm	Screws Wheelbase mm	UM	€
1114912	120	40	67	PCS	
1114917	155	54	87	PCS	
1114921	220	74	118	PCS	

**Foldable Stainless Steel Flush Cleat**

Foldable polished Stainless Steel mooring cleat. Assembly with studs. Does not require recess hole, can be lowered by folding it.

Code	L mm	W mm	UM	€
1114913	120	40	PCS	
1114918	155	54	PCS	
1114922	220	74	PCS	

**Pop-Up Stainless Steel Cleat**

Pop-Up Stainless Steel mooring cleat. The bollard appears and disappears with a single hand's press. Recessed cylinder wheelbase 45/55/78/108 mm.

Code	L mm	W mm	H mm	Screws Wheelbase mm	UM	€
1114712	125	31	52	98	PCS	
1114715	150	35	62	127	PCS	
1114720	200	46	86	152	PCS	
1114725	250	58	104	200	PCS	

**F-Line S Pop-Up Stainless Steel Cleat**

High quality Pop-Up mirror polished Stainless Steel mooring cleat. Italian design and manufacture, endowed with a soft and precise recessed mechanism, just a single hand's press is enough. Inner hidden stud mount.

Code	L mm	W mm	UM	€
1114718	180	37	PCS	

**F-Line L Pop-Up Stainless Steel Cleat**

High quality Pop-Up mirror polished Stainless Steel mooring cleat. Italian design and manufacture, endowed with a soft and precise recessed mechanism, just a single hand's press is enough. Inner hidden stud mount.

Code	L mm	W mm	UM	€
1114726	260	50	PCS	
1114735	350	60	PCS	



Stainless Steel Straight Chocks

Stainless Steel in line chocks.

Code	mm	Max Line ø mm	Wheelbase mm	UM	€
1133213	125 x 21	16	102	PCS	
1133215	150 x 23	20	129	PCS	
1133220	200 x 36	24	165	PCS	
1133225	250 x 38	30	205	PCS	

**Roller Chocks**

Stainless Steel in line chocks with lateral guide rollers. 2 Hidden metric stud holes base.

Code	mm	Max Line ø mm	Wheelbase mm	UM	€
1133520	205 x 40	20	120	PCS	
1133526	260 x 45	28	150	PCS	

**Stainless Steel Bow Chock**

316 Stainless Steel bow chock.

Code	mm	Wheelbase mm	UM	€
1133410	107 x 65	90	PCS	

**Stainless Steel Skene Chocks (R+L)**

Paired (right and left) Stainless Steel skene chocks. 2 mounting holes base.

Code	mm	Max Line ø mm	Wheelbase mm	UM	€
1133016	150 x 35	16	121	PR	
1133020	200 x 38	20	160	PR	
1133025	250 x 44	24	200	PR	

**Stainless Steel Narrow Skene Chocks (R+L)**

Paired (right and left) Stainless Steel skene chocks. 2 mounting holes base.

Code	mm	Max Line ø mm	Wheelbase mm	UM	€
1133011	115 x 20	14	84	PR	
1133015	150 x 25	16	121	PR	

**Hawse Pipe**

Stainless Steel hawse pipe.

Code	Flange mm	Hole mm	UM	€
1133400	138 x 62	82 x 33	PCS	
1133401	162 x 82	100 x 50	PCS	

**S/Steel Hawse Pipe with Rollers**

AISI 316 Stainless Steel hawse pipe with rollers. Flange mount on studs. Neck to be cut according to the desired thickness. Neck H 125 mm.

Code	Outer Dim mm	Cutout Dim mm	UM	€
1133408	340 x 160	280 x 100	PCS	



R.Marine 65 Bow Platform

316 Stainless Steel tubing and hardware bow platform. Teak wood platform.

Code	L cm	W cm	W1 cm	UM	€
1155006	65	33	28	PCS	



R.Marine 75 Bow Platform

316 Stainless Steel tubing and hardware bow platform. Teak wood platform.

Code	L cm	W cm	W1 cm	UM	€
1155007	75	48	33	PCS	



R.Marine 75 Roller Bow Platform

316 Stainless Steel tubing and hardware bow platform. Teak wood platform with bow roller.

Code	L cm	W cm	W1 cm	UM	€
1155008	75	48	33	PCS	



Stainless Steel Bow Platforms Roller

Stainless Steel bow platform roller.

Code	L mm	W mm	H mm	UM	€
1140401	150	75	150	PCS	
1140404	200	140	120	PCS	

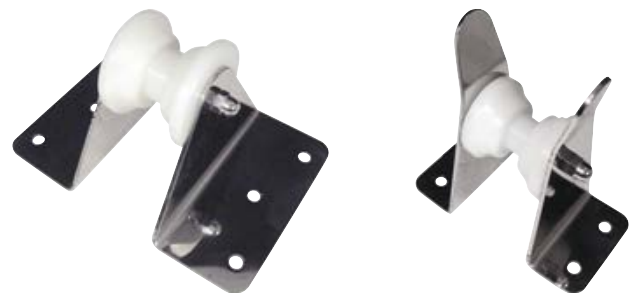

Compact Fix Bow Roller

Stainless Steel fixed bow roller.
Width 52 mm.

Code	L mm	Max Anchor Kg	UM	€
1140000	160	7,5	PCS	



Rising Fix Bow Roller

Stainless Steel fixed bow roller.
Width 52 mm.

Code	L mm	Max Anchor Kg	UM	€
1139901	150	7,5	PCS	



Classic Fix Bow Roller

Stainless Steel fixed bow roller. Anchor lock (optional).
Width 50 mm.

Code	L mm	Max Anchor Kg	Accessories	UM	€
1140001	150	7,5		PCS	
1140002	200	7,5		PCS	
1140012	250	10		PCS	
1140090			Anchor Lock	PCS	



Classic Rising Fix Bow Roller

Stainless Steel fixed bow roller. Anchor lock (optional).
Width 70 mm.

Code	L mm	Max Anchor Kg	Accessories	UM	€
1140009	270	10		PCS	
1140013	320	15		PCS	
1140016	400	15		PCS	
1140091			Anchor Lock	PCS	



Angled Fix Bow Roller

Stainless Steel fixed bow roller for Bruce - CQR – Delta anchors. Anchor lock (optional).

L= Length
W= Width

Code	Dim mm	Max Anchor Kg	Accessories	UM	€
1140003	L370 x W72	15		PCS	
1140004	L540 x W90	25		PCS	
1140091			Anchor Lock	PCS	



Plastic Spare Pulleys

Plastic spare pulley.

Code	L mm	ø mm	Hole ø mm	UM	€
1144050	48	54	13	PCS	
1144051	52	50	14	PCS	
1144052	50	56	11	PCS	
1144053	42	60	11	PCS	
1144054	55	60	15	PCS	
1144055	55	70	14,5	PCS	
1144056	58	70	14,5	PCS	
1144059	60	57	13	PCS	
1144060	62	54	13	PCS	
1144070	62	70	13	PCS	
1144071	73	70	11	PCS	
1144072	73	84	17	PCS	



Aster Pivoting Bow Roller

Outstanding finishing Stainless Steel pivoting bow roller. For Bruce - Delta - CQR – Rocna - Spade anchors. Anchor lock (optional).

L= Length
W= Width

Code	Dim mm	Max Anchor Kg	Accessories	UM	€
1140233	L330 x W125	15		PCS	
1140245	L450 x W100	25		PCS	
1140110			Anchor Lock	PCS	



Whale Pivoting Bow Roller

Stainless Steel pivoting bow roller for Bruce - Delta - CQR – Rocna - Spade anchors.

L= Length
W= Width

Code	Dim mm	Max Anchor Kg	Accessories	UM	€
1140030	L330 x W70	10		PCS	
1140031	L400 x W70	20		PCS	
1140032	L495 x W90	25		PCS	
1140033	L595 x W90	30		PCS	
1140034	L695 x W90	30		PCS	
1140091			Anchor Lock	PCS	



Classic Pivoting Bow Roller

Ribbed Stainless Steel pivoting bow roller. For Bruce - Delta - CQR – Rocna - Spade anchors. Anchor lock (optional).

L=Length
W= Width

Code	Dim mm	Max Anchor Kg	Accessories	UM	€
1140005	L280 x W80	10		PCS	
1140008	L340 x W80	12		PCS	
1140014	L400 x W80	15		PCS	
1140010			Anchor Lock	PCS	



Universal Pivoting Bow Roller

Universal Stainless Steel pivoting bow roller. Anchor lock (optional).

L= Length
W= Width

Code	Dim mm	Max Anchor Kg	Accessories	UM	€
1140202	L290 x W70	7		PCS	
1140203	L390 x W70	20		PCS	
1140204	L490 x W70	25		PCS	
1140110			Anchor Lock	PCS	



XL Pivoting Bow Roller

Stainless Steel pivoting bow roller. For Bruce - Delta - CQR – Rocna - Spade anchors. Anchor lock (optional).

L= Length
W= Width

Code	Dim mm	Max Anchor Kg	Accessories	UM	€
1140006	L420 x W76	15		PCS	
1140007	L560 x W80	30		PCS	
1140217	L750 x W90	30		PCS	
1140219	L950 x W95	50		PCS	
1140010			Anchor Lock	PCS	



Stainless Steel Bow Roller

Casted Stainless Steel mirror polished bow roller with anchor lock installed.

Code	L mm	Max Anchor Kg	UM	€
1141012	205	12	PCS	
1141014	335	15	PCS	



Custom Line CL1 Windlass

Anchor windlass with Bronze and Stainless Steel traction parts. Stainless Steel base and case (Inner Composite Structure). Manual Free-Fall chain system. IP67 watertight motor. Complete with control box and handle.

Code	Ref	V	Chain ø mm	Kg	Working Load Kg	Max Working Load Kg	For Boats	UM	€
1202402	CL1 500W	12	6	7,6	65	200	From 6 to 9 Meters	PCS	

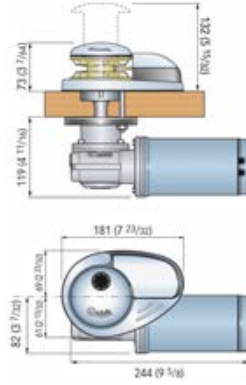

Custom Line CL2 Windlass

Rope and chain anchor windlass with Bronze and Stainless Steel traction parts. Endowed with pressure lever and manual Free-Fall chain system. Stainless Steel base and case (Inner Composite Structure). IP67 watertight motor. The custom line economic series windlasses are without chaincounter sensor. Complete with control box and handle.

Code	Ref	V	Chain ø mm	Rope ø mm	Kg	Working Load Kg	Max Working Load Kg	For Boats	UM	€
1202602	CL2 700W	12	6	12	15,6	100	300	From 7 to 10 Meters	PCS	
1202604	CL2 700W	12	8	12	15,6	100	300	From 7 to 10 Meters	PCS	

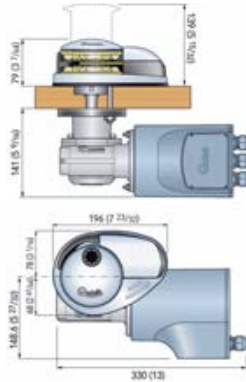

Custom Line CL3 Windlass

Rope and chain anchor windlass with Bronze and Stainless Steel traction parts. Endowed with Manual Free-Fall chain system and pressure lever. Stainless Steel base and case. IP67 watertight motor. Complete with control box and handle. The custom line economic series windlasses are without chaincounter sensor.

Code	Ref	V	Chain ø mm	Rope ø mm	Kg	Working Load Kg	Max Working Load Kg	For Boats	UM	€
1203208	CL3 1000W	12	8	12	16,7	120	370	From 10 to 13 Meters	PCS	

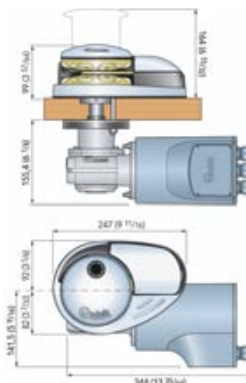

Prince DP1 Windlass

Anchor windlass with Bronze and Stainless Steel traction parts. Endowed with chaincounter sensor and Manual Free-Fall chain system. Stainless Steel base and case (Inner Composite Structure). IP67 watertight motor. Complete with control box and handle.

(The D letter in Ref column indicates Drum equipped winch)

Code	Ref	V	Chain ø mm	Kg	Working Load Kg	Max Working Load Kg	For Boats	UM	€
1202404	DP1 500W	12	6	7,6	65	200	From 6 to 9 Meters	PCS	
1202406	DP1 500W-D	12	6	7,6	65	200	From 6 to 9 Meters	PCS	

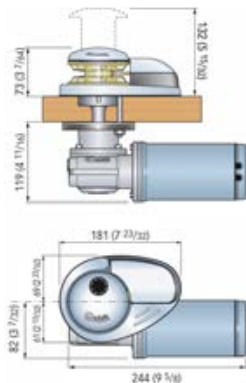

Prince DP2 Windlass

Rope and chain anchor windlass with Bronze and Stainless Steel traction parts. Endowed with chaincounter sensor and Manual Free-Fall chain system. Emergency manual lift system and pressure lever. Complete with control box and handle. Stainless Steel base and case (Inner Composite Structure). IP67 watertight motor.

(The D letter in Ref column indicates Drum equipped winch)

Code	Ref	V	Chain ø mm	Rope ø mm	Kg	Working Load Kg	Max Working Load Kg	For Boats	UM	€
1202606	DP2 700W	12	6	12	15,6	100	300	From 7 to 10 Meters	PCS	
1202608	DP2 700W	12	8	12	15,6	100	420	From 7 to 10 Meters	PCS	
1203204	DP2 1000W	12	8	12	16,7	140	420	From 9 to 13 Meters	PCS	
1203206	DP2 1000W-D	12	8	12	17,4	140	420	From 9 to 13 Meters	PCS	

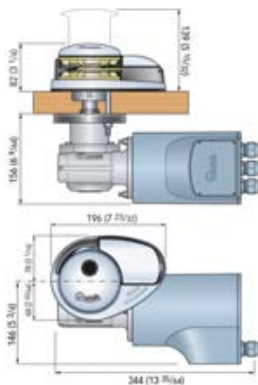

Prince DP3-1000 Windlass

Rope and chain anchor windlass with Bronze and Stainless Steel traction parts. Endowed with chaincounter sensor and Manual Free-Fall chain system. Emergency manual lift system and pressure lever. Complete with control box and handle. Stainless Steel base and case. IP67 watertight motor.

(The D letter in Ref column indicates Drum equipped winch)

Code	Ref	V	Chain ø mm	Rope ø mm	Kg	Working Load Kg	Max Working Load Kg	For Boats	UM	€
1203210	DP3 1000W	12	8	12	18,1	120	370	From 10 to 13 Meters	PCS	
1203212	DP3 1000W-D	12	8	12	19,1	120	370	From 10 to 13 Meters	PCS	

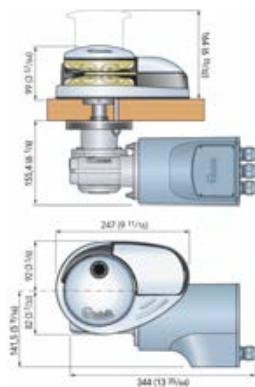

Prince DP2E Windlass

Rope and Chain anchor windlass with Bronze and Stainless Steel traction parts. Endowed with chaincounter sensor and Manual Free-Fall chain system. Anodized Aluminum base and case (Inner Composite Structure). IP67 watertight motor. Easy and quick to install from top. Complete with control box and handle. (The D letter in Ref column indicates Drum equipped winch)

Code	Ref	V	Chain ø mm	Rope ø mm	Kg	Working Load Kg	Max Working Load Kg	For Boats	UM	€
1201815	DP2E 500W	12	6	12	8,3	65	200	From 6 to 9 Meters	PCS	
1201825	DP2E 500W-D	12	6	12	9,1	65	200	From 6 to 9 Meters	PCS	
1201816	DP2E 800W	12	6	12	8,3	95	290	From 7 to 10 Meters	PCS	
1201818	DP2E 800W	12	8	12	8,3	95	290	From 7 to 10 Meters	PCS	
1201828	DP2E 800W-D	12	8	12	9,1	95	290	From 7 to 10 Meters	PCS	

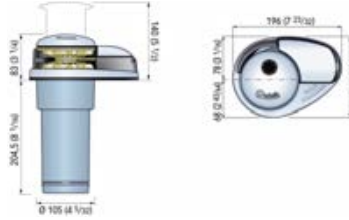

Rider R1 Windlass

Anchor windlass with Bronze and Stainless Steel traction parts. Endowed with chaincounter sensor and Manual Free-Fall chain system. Anodized Aluminum base. IP67 watertight motor. Complete with control box and handle. Windlass without chain pipe, thus it can be mounted in any position, vertical or horizontal angle, even in the chain locker. (The D letter in Ref column indicates Drum equipped winch)

Code	Ref	V	Chain ø mm	Kg	Working Load Kg	Max Working Load Kg	For Boats	UM	€
1203504	Rider 500W	12	6	7,4	65	200	From 6 to 9 Meters	PCS	
1203514	Rider 500W-D	12	6	8,5	65	200	From 6 to 9 Meters	PCS	

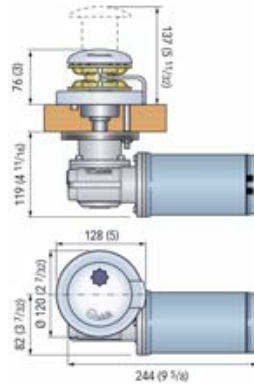

Rider R3 Windlass

Anchor windlass with Bronze and Stainless Steel traction parts. Endowed with chaincounter sensor and Manual Free-Fall chain system. Anodized Aluminum base. IP67 watertight motor. Complete with control box and handle. Windlass without chain pipe, thus it can be mounted in any position, vertical or horizontal angle, even in the chain locker. (The D letter in Ref column indicates Drum equipped winch)

Code	Ref	V	Chain ø mm	Kg	Working Load Kg	Max Working Load Kg	For Boats	UM	€
1203510	Rider 1000W	12	8	17,1	120	370	From 9 to 13 Meters	PCS	
1203520	Rider 1000W-D	12	8	19,1	120	370	From 9 to 13 Meters	PCS	

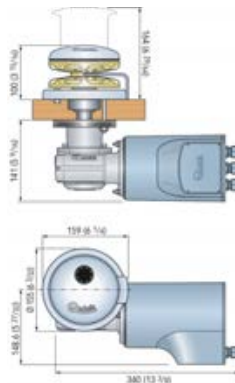

Prince DP3-1500 Windlass

Rope and chain anchor windlass with Bronze and Stainless Steel traction parts. Endowed with chaincounter sensor and Manual Free-Fall chain system. Emergency manual lift system and pressure lever. Complete with control box and handle. Stainless Steel base and case. IP67 watertight motor.
(The D letter in Ref column indicates Drum equipped winch)

Code	Ref	V	Chain ø mm	Rope ø mm	Kg	Working Load Kg	Max Working Load Kg	For Boats	UM	€
1203402	DP3 1500W	12	10	16	20,4	160	470	From 12 to 15 Meters	PCS	
1203404	DP3 1500W-D	12	10	16	21,4	160	470	From 12 to 15 Meters	PCS	
1203406	DP3 1500W	24	10	16	20,4	180	540	From 12 to 15 Meters	PCS	
1203408	DP3 1500W-D	24	10	16	21,4	180	540	From 12 to 15 Meters	PCS	

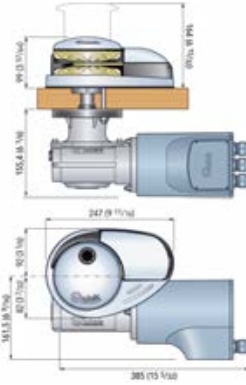

Dylan H-1500/1700 Windlass

Rope and chain anchor windlass with Bronze and Stainless Steel traction parts. Endowed with chaincounter sensor and Manual Free-Fall chain system. Emergency manual lift system and pressure lever. Complete with control box and handle. Stainless Steel and hard oxide Anodized Aluminum base and case. IP67 watertight motor.
(The D letter in Ref column indicates Drum equipped winch)

Code	Ref	V	Chain ø mm	Rope ø mm	Kg	Working Load Kg	Max Working Load Kg	For Boats	UM	€
1203755	Dylan 1500W	12	10	16-20	25,8	135	400	From 12 to 15 Meters	PCS	
1203758	Dylan 1500W-D	12	10	16-20	27,8	135	400	From 12 to 15 Meters	PCS	
1203765	Dylan 1700W	24	10	16-20	26,4	190	570	From 14 to 16 Meters	PCS	
1203768	Dylan 1700W-D	24	10	16-20	28,8	190	570	From 14 to 16 Meters	PCS	

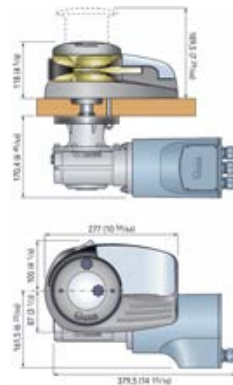
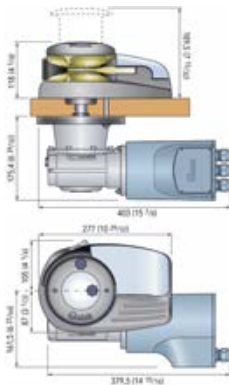

Dylan H-2000 Windlass

Rope and chain anchor windlass with Bronze and Stainless Steel traction parts. Endowed with chaincounter sensor and Manual Free-Fall chain system. Emergency manual lift system and pressure lever. Complete with control box and handle. Stainless Steel and hard oxide Anodized Aluminum base and case. IP67 watertight motor.
(The D letter in Ref column indicates Drum equipped winch)

Code	Ref	V	Chain ø mm	Rope ø mm	Kg	Working Load Kg	Max Working Load Kg	For Boats	UM	€
1203772	Dylan 2000W	24	12	18-20	31,4	250	750	From 15 to 20 Meters	PCS	
1203774	Dylan 2000W-D	24	12	18-20	33,4	250	750	From 15 to 20 Meters	PCS	

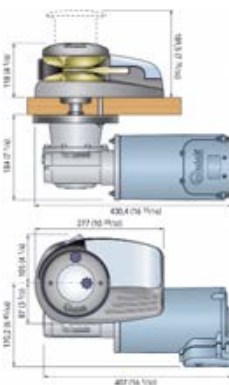

Hector HC3 1000W Windlass

Rope and chain on a single gypsy On Deck anchor windlass with drum. Anodized Aluminum and Composite base and case. Bronze and Stainless Steel drum and traction parts. IP66 watertight motor endowed with chaincounter sensor and integrated solenoids. Complete with control box and handle. Manual Free-Fall chain system and emergency manual lift system.

Code	Ref	V	Chain ø mm	Rope ø mm	Working Load Kg	Max Working Load Kg	For Boats	UM	€
1221010	Hector 1000W - D	12	8	14	130	400	From 10 to 13 meters	PCS	
1221014	Hector 1000W - D	24	8	14	160	490	From 10 to 13 meters	PCS	

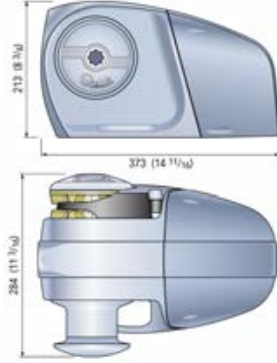

Hector HC3 1500W Windlass

Rope and chain on a single gypsy On Deck anchor windlass with drum. Anodized Aluminum and Composite base and case. Bronze and Stainless Steel drum and traction parts. IP66 watertight motor endowed with chaincounter sensor and integrated solenoids. Complete with control box and handle. Manual Free-Fall chain system and emergency manual lift system.

Code	Ref	V	Chain ø mm	Rope ø mm	Working Load Kg	Max Working Load Kg	For Boats	UM	€
1221115	Hector 1500W - D	12	10	16	150	450	From 12 to 15 meters	PCS	
1221125	Hector 1500W - D	24	10	16	185	550	From 12 to 15 meters	PCS	

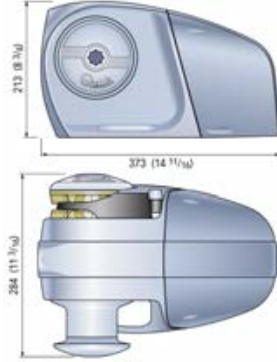

Heroes HR5 1700/2300W Windlass

On Deck anchor windlass for big boats. White lacquered Anodized Aluminum base and case. Bronze and Stainless Steel drum and traction parts. IP66 watertight motor endowed with chaincounter sensor and integrated solenoids. Complete with control box and handle. Manual Free-Fall chain system and emergency manual lift system.

Code	Ref	V	Chain ø mm	Working Load Kg	Max Working Load Kg	For Boats	UM	€
1221129	Heroes HR5 1700W - D	12	12-13	200	500	From 12 to 16 meters	PCS	
1221130	Heroes HR5 1700W - D	24	12-13	250	600	From 12 to 16 meters	PCS	
1221134	Heroes HR5 2300W - D	24	12-13	285	850	From 15 to 20 meters	PCS	



Genius GP2 150W Windlass

Rope and chain on a single gypsy On Deck anchor windlass. Reinforced Composite material case, Bronze and Stainless Steel traction parts. Endowed with chaincounter sensor, Manual Free-Fall chain system and pressure lever. IP66 watertight motor. Complete with control box and handle.

Code	Ref	V	Chain ø mm	Rope ø mm	Weight Kg	Working Load Kg	Max Working Load Kg	For Boats	UM	€
1238105	Genius 150W	12	6	12	6	35	70	From 6 to 7 Meters	PCS	

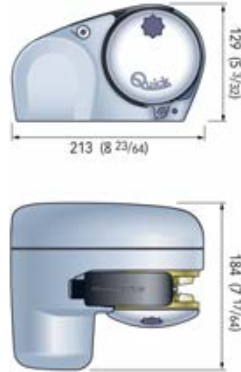

Genius GP2 250W Windlass

Rope and chain on a single gypsy On Deck anchor windlass. Anodized Aluminum case, Bronze and Stainless Steel traction parts. Endowed with chaincounter sensor, manual free fall chain system and pressure lever. IP66 watertight motor. Complete with control box and handle. "Free Fall" automatic chain system available only on FF types.

Code	Ref	V	Chain ø mm	Rope ø mm	Weight Kg	Working Load Kg	Max Working Load Kg	For Boats	UM	€
1238106	GP2 250W	12	6	12	8	50	170	From 6 to 7 Meters	PCS	
1238107	GP2 250W FF	12	6	12	8	50	170	From 6 to 7 Meters	PCS	

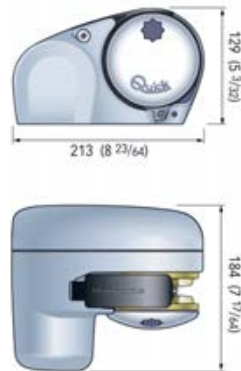

Genius GP2 500/800W Windlass

Rope and chain on a single gypsy On Deck anchor windlass. Anodized Aluminum base and case, Bronze and Stainless Steel traction parts. Endowed with chaincounter sensor, manual free fall chain system and pressure lever. IP66 watertight motor. Complete with control box and handle. "Free Fall" automatic chain system available only on FF types.

Code	Ref	V	Chain ø mm	Rope ø mm	Weight Kg	Working Load Kg	Max Working Load Kg	For Boats	UM	€
1238112	GP2 500W	12	6	12	10,5	85	250	From 6 to 9 Meters	PCS	
1238113	GP2 500W FF	12	6	12	10,5	85	250	From 6 to 9 Meters	PCS	
1239112	GP2 800W	12	8	12-14	10,5	120	350	From 8 to 12 Meters	PCS	
1239113	GP2 800W FF	12	8	12-14	10,5	120	350	From 8 to 12 Meters	PCS	

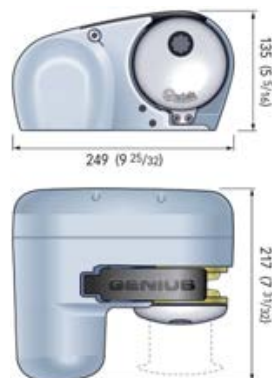

Eagle E1- 500 Windlass

Horizontal anchor windlass with Bronze and Stainless Steel traction parts. Endowed with chaincounter sensor and Manual Free-Fall chain system. Anodized Aluminum base and case. IP67 watertight motor. Complete with control box and handle.

Code	Ref	V	Chain ø mm	Kg	Working Load Kg	Max Working Load Kg	For Boats	UM	€
1202524	Eagle 500W	12	6	9,3	80	250	From 6 to 9 meters	PCS	

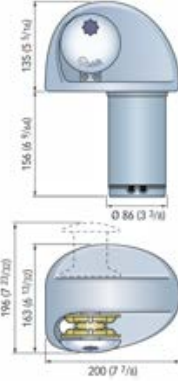

Eagle E3- 700 Windlass

Horizontal anchor windlass with Bronze and Stainless Steel traction parts. Endowed with chaincounter sensor and Manual Free-Fall chain system. Anodized Aluminum base and case. IP67 watertight motor. Complete with control box and handle.

Code	Ref	V	Chain ø mm	Kg	Working Load Kg	Max Working Load Kg	For Boats	UM	€
1202527	Eagle 700W	12	6	22,6	100	300	From 7 to 10 meters	PCS	

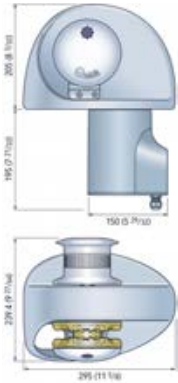

Eagle E3- 1000 Windlass

Horizontal anchor windlass with Bronze and Stainless Steel traction parts. Endowed with chaincounter sensor and Manual Free-Fall chain system. Anodized Aluminum base and case. IP67 watertight motor. Complete with control box and handle.

Code	Ref	V	Chain ø mm	Kg	Working Load Kg	Max Working Load Kg	For Boats	UM	€
1202532	Eagle 1000W	12	8	23,7	130	390	From 9 to 13 meters	PCS	

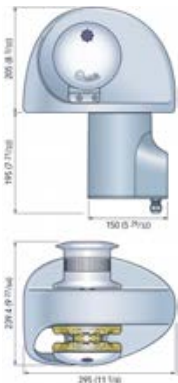

Tumbler 1 Capstan

316 Stainless Steel base and drum capstans. IP67 Watertight motor. Complete with control box and handle. For boats from 6 to 13 meters.

Code	Ref	V	Dim mm	Working Load Kg	Max Working Load Kg	For Boats	UM	€
1203804	TB2 500W Small Drum	12	H 103 / H1 119 / D 25<>50	65	200	From 6 to 9 meters	PCS	
1203807	TB3 700W Small Drum	12	H 113 / H1 141 / D 25<>50	80	250	From 7 to 10 meters	PCS	
1203810	TB3 1000W Small Drum	12	H 113 / H1 141 / D 25<>50	120	370	From 10 to 13 meters	PCS	

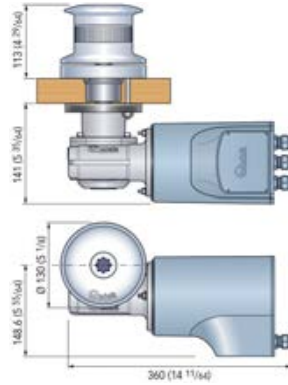

Tumbler 2 Capstan

316 Stainless Steel base and drum capstans. IP67 Watertight motor. Complete with control box and handle. For boats from 14 to 22 meters.

Code	Ref	V	Dim mm	Working Load Kg	Max Working Load Kg	For Boats	UM	€
1203811	TB4 1000W Large Drum	12	H 120 / H1 167 / D 30<>50	120	370	From 14 to 18 meters	PCS	
1203812	TB4 1000W Large Drum	24	H 120 / H1 167 / D 30<>50	150	450	From 14 to 18 meters	PCS	
1203814	TB4 1500W Large Drum	12	H 120 / H1 167 / D 30<>50	150	450	From 16 to 22 meters	PCS	
1203816	TB4 1500W Large Drum	24	H 120 / H1 167 / D 30<>50	170	500	From 16 to 22 meters	PCS	

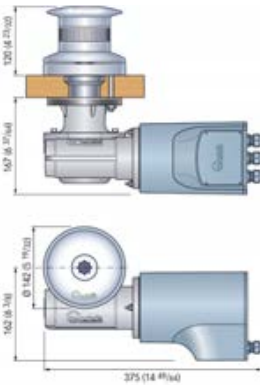

Tumbler 3 Capstan

316 Stainless Steel base and extra large drum capstans. IP67 Watertight motor. Complete with control box and handle. For boats from 18 to 30 meters.

Code	Ref	V	Dim mm	Working Load Kg	Max Working Load Kg	For Boats	UM	€
1203820	TB5 1700W Large Drum	24	H 135 / H1 173 / D 30<>70	190	570	From 18 to 24 meters	PCS	
1203824	TB5 2000W Large Drum	24	H 135 / H1 180 / D 30<>70	250	750	From 20 to 28 meters	PCS	
1203826	TB6 2300W Large Drum	24	H 160 / H1 185 / D 30<>70	285	850	From 24 to 30 meters	PCS	

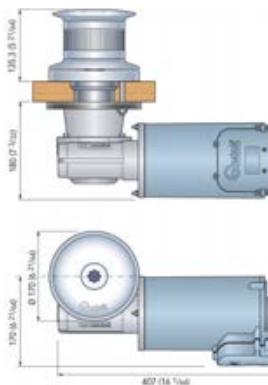
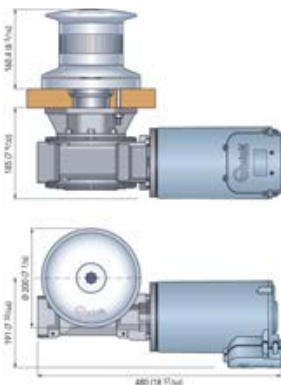

Totem Capstan

Anodized Aluminum base and Chromed Bronze drum capstans. IP67 Vertical mount watertight motor for an easier installation. Complete with control box and handle.

Code	Ref	V	Working Load Kg	Max Working Load Kg	For Boats	UM	€
1203806	TM3 500W	12	65	200	From 8 to 12 meters	PCS	
1203808	TM3 800W	12	95	290	From 11 to 14 meters	PCS	
1203809	TM3 800W	24	95	290	From 11 to 18 meters	PCS	

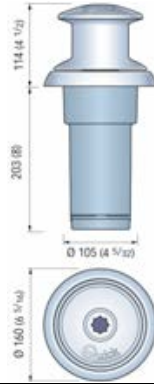

Totem G Capstan

No recess on-deck mount capstans for tenders. Chromed Bronze base and Anodized Aluminum drum. IP67 Watertight motor with epicyclical gearbox. Complete with control box and handle.

Code	Ref	V	Weight Kg	Working Load Kg	Max Working Load Kg	UM	€
1203845	TMG 500W	12	9,5	65	200	PCS	
1203846	TMG 800W	12	9,5	95	290	PCS	
1203847	TMG 800W	24	9,5	95	290	PCS	

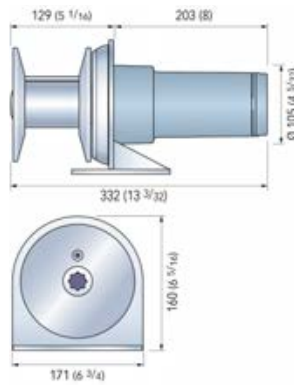

THG Capstan

Capstan with strap roller. Ideal for retrieving tenders or any other load without using the rope. Anodized Aluminum base and roller drum. IP67 watertight motor with epicyclical gearbox. Complete with control box and Polymer cover.

Code	Ref	V	Weight Kg	Working Load Kg	Max Working Load Kg	UM	€
1203870	THG 500W	12	14	200	600	PCS	
1203872	THG 1000W	12	19	300	750	PCS	
1203874	THG 1000W	24	19	350	750	PCS	

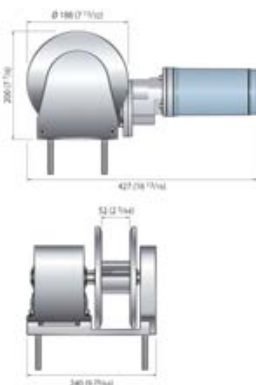

Up-Down Switch Panel

Up-Down 12/24V switch panel with toggle or rocker switch.

Code	Switch	UM	€
1205202	Toggle	PCS	
1205200	Rocker	PCS	



Up-Down Foot Switch

Up-Down 12/24V pair foot switches. Stainless Steel body with shock-resistant Plastic cover.

Code	Colour	UM	€
1205220	BLACK	PR	
1205222	WHITE	PR	



Up-Down S/Steel Foot Switch

Up-Down 12/24V pair foot switches with Stainless Steel body and cover.

Code	Colour	UM	€
1205216	BLACK	PR	
1205218	WHITE	PR	



Up-Down Remote Control

Handheld Up-Down remote control with 4,2 meters extendible cable. Waterproof, with watertight plug and support bracket. Universal 12/24V power supply. Available with or without LED torch.

Code	Buttons	LED Light	Spare Parts	UM	€
1215300	2	No		PCS	
1215301	2	Yes		PCS	
1215525			Socket	PCS	

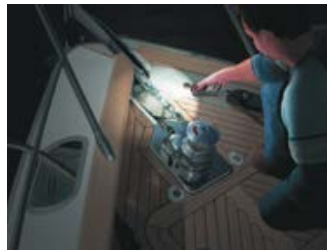

HRC Watertight Multipurpose Remote Controls

HRC watertight handheld remote controls used to operate cranes, gangways, sea ladders, windlasses, etc. Built with shockproof rubber inserts to improve grip. With up to 4,2 meters extendible cable, watertight plug, support bracket and integrated LED light on request.

Code	Buttons	LED Light	Spare Parts	UM	€
1215302	4	No		PCS	
1215303	4	Yes		PCS	
1215304	6	No		PCS	
1215305	6	Yes		PCS	
1215306	8	No		PCS	
1215307	8	Yes		PCS	
1215525			Socket	PCS	

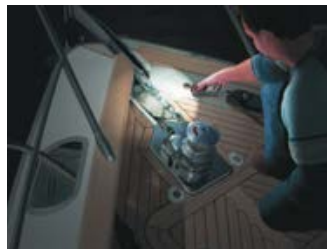

Up-Down Chain-Counter Remote Control

Handheld IP67 12/24V Up-Down chain counter with 4,2 m extendible cable and integrated LED light. Endowed with waterproof plug, chaincounter sensor and bracket. With automatic fall and raise alarm functions, counts the feet or meters length of eased-off chain, its speed and power supply volts. 5 languages dimmerable display, backlighted buttons and CAN bus data interface.

Code	Buttons	LED Light	Spare Parts	UM	€
1215500	2	Yes		PCS	
1215525			Socket	PCS	



Up-Down Chain-Counter Panel

IP67 Waterproof 12/24V LCD Up-Down panel to manoeuvre from a distance the windlass and at the same time to control the length of the lowered chain. With automatic release, free fall and up alarm functions. Displays the length and the speed of the released chain. Complete with chain-counter sensor and CAN bus data interface.

Code	Mount	Dim mm	UM	€
1215510	Surface	102 x 102 x H19	PCS	
1215512	Flush	110 x 110 x H22+2	PCS	



Handheld Radio Remote Control

Radio remote control for windlasses, davits, gangways, etc. Multiple receivers can be controlled with the same remote control. Two functions can be activated simultaneously. LED diodes backlit keyboard. Floating, IP67 watertight.

Code	Buttons	UM	€
1205522	2	PCS	
1205524	4	PCS	
1205532	12	PCS	



Pocket Transmitter

Pocket radio remote control for windlasses, davits, gangways, etc. Multiple receivers can be controlled with the same remote control. Two functions can be activated simultaneously. Floating, IP67 watertight.

Code	Channels	UM	€
1215322	2	PCS	
1205340	4	PCS	



Receivers for Remote Control

Radio remote control receivers from 2 to 12 relays/channels, 12/24V universal power supply and optimized 25mA power absorption. With 7 level operating status LED and display indicator. Polarity inversion and low battery protection. Can store up to 50 transmitters. Two functions can be activated simultaneously. Can be connected to an external antenna.

Code	Channels / Relays	UM	€
1205722	2	PCS	
1205724	4	PCS	
1205726	6	PCS	
1205732	12	PCS	



Circuit Breakers

Automatic circuit breaker specific for direct current that protects from overloads the motor of the winch and the electrical equipment on board. Manual switch-on, can be used up to 80Vdc.

Code	Trip Current	UM	€
1205204	40 A	PCS	
1205205	50 A	PCS	
1205206	60 A	PCS	
1205208	80 A	PCS	
1205210	100 A	PCS	

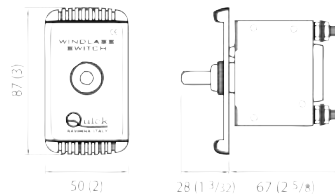

HD Circuit Breakers

Automatic circuit breaker specific for direct current that protects from overloads the motor of the winch and the electrical equipment on board. Manual switch-on, can be used up to 80Vdc.

Code	Trip Current	UM	€
1205250	125 A	PCS	
1205251	150 A	PCS	
1205252	200 A	PCS	

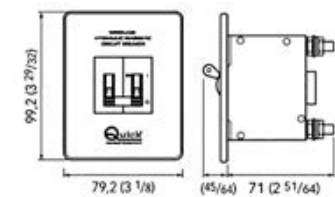

Control Box (Solenoids)

IP67 watertight control box. Can operate windlasses and capstans electric motors. Equipped with external connections for easy installation. Standard equipment on all Quick windlasses.

Code	Max Motor Power	Outlets	V	Dimensions mm	UM	€
1205012	<2500 W	4	12	99,4 x 96 x 64	PCS	
1205312	<2500 W	3	12	99,4 x 96 x 64	PCS	
1205324	<3500 W	3	24	99,4 x 96 x 64	PCS	



Chain-Counter Sensor

Chain-counter sensor to be installed on the winch to control the length of the released chain.

Code	UM	€
1215520	PCS	



Spare Handles for Quick Windlasses

Spare handles for Quick windlasses.

Code	Ref	UM	€
1205800	Aluminum Handle (with Knob)	PCS	
1205801	Nylon Handle	PCS	



Gypsy

Spare gypsies for Quick windlasses.

Code	For Windlass	W	Chain ø mm	UM	€
1210606	Aries-Flair-Rider-Eagle-Prince DP	300-500	6	PCS	
1210607	Aries-Flair-Rider-Eagle-Prince DP	300-500	7	PCS	
1210706	Aries-Flair-Rider	700-1000-1400	6	PCS	
1210708	Aries-Flair-Rider	700-1000-1400	8	PCS	
1210710	Aries-Rider	700-1000-1400	10	PCS	
1210806	Genius-Genius FF		6	PCS	
1210808	Genius-Genius FF		8	PCS	
1210906	Prince DP2		6	PCS	
1210908	Prince DP2		8	PCS	
1210909	Prince DP3		8	PCS	
1210911	Prince DP3		10	PCS	
1211008	Hector		8	PCS	
1211010	Hector		10	PCS	



Electric Motors for Windlasses

Spare electric motors for Quick windlasses.

Code	For Windlass	W	V	UM	€
1213003	Aries-Flair-Rider-Eagle-Aster	300	12	PCS	
1213005	Aries-Flair-Rider-Eagle-Aster-Heron-DP1	500	12	PCS	
1213007	Aries-Flair-Rider-Eagle-Aster-Heron-DP2	700	12	PCS	
1213010	Aries-Flair-Rider-Eagle-Aster-Heron-DP2	1000	12	PCS	
1213015	Aries-Flair-Rider-Eagle-Tauro-Antares-Hector-DP3	1500	12	PCS	
1213017	Rider-Regal	1700	12	PCS	
1213208	Genius-Crystal-Totem	800	12	PCS	
1213410	Antares-Aries-Flair-Rider-Eagle-Aster-Tauro	1000	24	PCS	
1213415	Antares-Aries-Flair-Rider-Tauro-Hector	1500	24	PCS	
1213417	Rider-Regal	1700	24	PCS	
1213420	Rider-Regal	2000	24	PCS	



RC6 Windlass

Low profile rope and chain anchor windlass with Bronze and Stainless Steel traction parts. The innovative Maxwell Wave Design rope/chain chainwheel greatly improves handling of rope/chain spliced rode which is smoothly guided in the wheel during anchor retrieval. The in-line vertical gearbox and motor means quick and easy installation. Complete with dual direction solenoid.

Code	Ref	V	Chain ø	Rope ø	Max Load	Boats	UM	€
1204006	RC6 500W	12	6-7mm	12mm	350 Kg	5<>9m	PCS	



RC8 Windlass

Rope and chain anchor windlass with Bronze and Stainless Steel traction parts. The innovative Maxwell Wave Design rope/chain chainwheel greatly improves handling of rope/chain spliced rode which is smoothly guided in the wheel during anchor retrieval. The in-line vertical gearbox and motor means quick and easy installation. Complete with emergency clutch handle and dual direction solenoid.

(The D letter in Ref column indicates Drum equipped winch)

Code	Ref	V	Chain ø	Rope ø	Max Load	Boats	UM	€
1204106	RC8 600W	12	6-7mm	12mm	350 Kg	6<>10m	PCS	
1204116	RC8 600W-D	12	6-7mm	12mm	350 Kg	6<>10m	PCS	



RC10 Windlass

Rope and chain anchor windlass with Bronze and Stainless Steel traction parts. The innovative Maxwell Wave Design rope/chain chainwheel greatly improves handling of rope/chain spliced rode which is smoothly guided in the wheel during anchor retrieval. Endowed with clutch/brake mechanism which permits manual free fall anchoring. The in-line vertical gearbox and motor means quick and easy installation. Complete with dual direction solenoid.

(The D letter in Ref column indicates Drum equipped winch)

Code	Ref	V	Chain ø	Rope ø	Max Load	Boats	UM	€
1204208	RC10 1000W	12	8mm	14mm	700 Kg	10<>14m	PCS	
1204210	RC10 1200W	12	10mm	16mm	850 Kg	11<>16m	PCS	
1204211	RC10 1200W	24	10mm	16mm	850 Kg	11<>16m	PCS	
1204218	RC10 1000W-D	12	8mm	14mm	700 Kg	10<>14m	PCS	
1204220	RC10 1200W-D	12	10mm	16mm	850 Kg	11<>16m	PCS	
1204221	RC10 1200W-D	24	10mm	16mm	850 Kg	11<>16m	PCS	



RC12 Windlass

Rope and chain anchor windlass with Bronze and Stainless Steel traction parts. The innovative Maxwell Wave Design rope/chain chainwheel greatly improves handling of rope/chain spliced rode which is smoothly guided in the wheel during anchor retrieval. Endowed with clutch/brake mechanism which permits manual free fall anchoring and with Maxwell's Active Latch Rathcet System that prevents backwind of the windlass during manual hauling of the anchor. The in-line vertical gearbox and motor means quick and easy installation. Complete with dual direction solenoid.

(The D letter in Ref column indicates Drum equipped winch)

Code	Ref	V	Chain ø	Rope ø	Max Load	Boats	UM	€
1204312	RC12 1200W-D	12	12mm	16-20mm	1590 Kg	13<>21m	PCS	
1204313	RC12 1200W-D	24	12mm	16-20mm	1590 Kg	13<>21m	PCS	



HRCFF Windlass

Rope and chain anchor windlass with Bronze and Stainless Steel traction parts and die-cast marine grade Anodized Aluminum case. The innovative Maxwell Wave Design rope/chain chainwheel greatly improves handling of rope/chain spliced rode which is smoothly guided in the wheel during anchor retrieval. Endowed with clutch/brake mechanism which permits manual free fall anchoring. Complete with dual direction solenoid.

Code	Ref	V	Chain ø mm	Rope ø mm	Kg	Max Working Load Kg	For Boats	UM	€
1204606	HRCFF6 600W	12	6	12	11,5	270	From 6 to 11 Meters	PCS	
1204608	HRCFF8 600W	12	8	14	11,5	410	From 10 to 14 Meters	PCS	

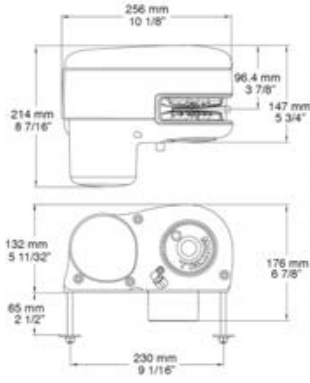

HRC10 Windlass

Rope and chain anchor windlass with Bronze and Stainless Steel traction parts and die-cast marine grade Anodized Aluminum case. The innovative Maxwell Wave Design rope/chain chainwheel greatly improves handling of rope/chain spliced rode which is smoothly guided in the wheel during anchor retrieval. Endowed with clutch/brake mechanism which permits manual free fall anchoring. Complete with dual direction solenoid.

Code	Ref	V	Chain ø mm	Rope ø mm	Kg	Max Working Load Kg	For Boats	UM	€
1204708	HRC10 1000W	12	8	14-16	13	700	From 10 to 14 Meters	PCS	
1204710	HRC10 1200W	12	10	16	13	850	From 11 to 16 Meters	PCS	
1204711	HRC10 1200W	24	10	16	13	850	From 11 to 16 Meters	PCS	

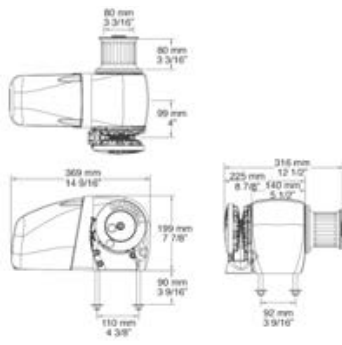

HWC3500 Windlass

Rope and chain anchor windlass with Bronze and Stainless Steel traction parts and die-cast marine grade alloy case. Fully automatic single or dual direction chainwheel operation. The innovative Maxwell Wave Design rope/chain chainwheel greatly improves handling of rope/chain spliced rode which is smoothly guided in the wheel during anchor retrieval. Endowed with clutch/brake mechanism which permits manual free fall anchoring. Complete with dual direction solenoid.

Code	Ref	V	Chain ø mm	Kg	Max Working Load Kg	For Boats	UM	€
1204914	HWC3500 1200W	24	10-13	49	1590	From 15 to 21 Meters	PCS	

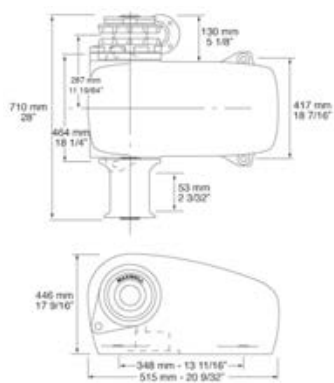

Up-Down Standard Panel

Joystick toggle type Up-Down standard panel. Manufactured from splash proof marine-grade materials.

Code	V	UM	€
1205004	12/24	PCS	



MAXWELL

Up-Down Button Panel

Push button type Up-Down panel with on-off switch and power indicator light. Manufactured from splash proof marine-grade materials.

Code	V	UM	€
1205006	12/24	PCS	



MAXWELL

Up-Down Foot Switch

Up-Down foot switch with UV stabilised water proof diaphragm. Adjustable arrow for Up or Down setting.

Code	Colour	V	UM	€
1205231	Black	12/24	PCS	
1205232	White	12/24	PCS	



MAXWELL

Up-Down Hand Held Control

Up-Down hand held control for windlasses or other marine equipment. With Rubber over-moulding shock protection, 4 meters cable and connectors. The hand held control, cables, plugs and sockets are all IP67 watertight.

Code	UM	€
1205151	PCS	



MAXWELL

Up-Down Hand Held Multi Control

Dual Up-Down hand held control for windlasses or other marine equipment. With Rubber over-moulding shock protection, 4 meters cable and connectors. The hand held control, cables, plugs and sockets are all IP67 watertight.

Code	UM	€
1205152	PCS	



MAXWELL

Up-Down Hand Held Chain-Counter Control

Up-Down hand held length/chain counter control for windlasses or other marine equipment. With Rubber over-moulding shock protection, 4 meters cable and connectors. The hand held control, cables, plugs and sockets are all IP67 watertight.

Code	UM	€
1205153	PCS	



MAXWELL

Up-Down Hand Held Radio Control

Single or dual Up-Down hand held radio control for windlasses or other marine equipment.

Code	Ref	UM	€
1205512	Single	PCS	
1205514	Dual	PCS	



MAXWELL

Up-Down Chain-Counter Hand Held Radio Control

LCD display Up-Down length/chain counter hand held radio control. Powered with 2 AA type batteries, can operate more than one electrical equipment. Endowed with preset stopping point and docking alarm on retrieval, one-touch function to deploy and retrieve a preset length of rode. Displays windlass speed and direction, safety lock to protect accidental windlass deployment. Non-slip Rubber moulding, IP65 watertight, secure ISM data transmission at 2,4 GHz. Kit includes base-station, sensor and magnet.

Code	UM	€
1205554	PCS	



MAXWELL

Up-Down Chain-Counter Radio Control Panel

LCD display Up-Down length/chain counter radio control panel. When 12/24V powered, it instantly connects to the (included) wireless base-station. Can operate 2 windlasses from a single station, easy multiple station set-up. Endowed with preset stopping point and docking alarm on retrieval, one-touch function to deploy and retrieve a preset length of chain. Displays windlass speed and direction, safety lock to protect accidental windlass deployment. Secure 16 channel data transmission, 10 meters range.

Code	UM	€
1205552	PCS	



MAXWELL

Up-Down Chain-Counter Panel

LCD display Up-Down chain counter control panel for windlasses. Endowed with preset stopping point and docking alarm on retrieval, one-touch function to deploy and retrieve a preset length of rode. Displays windlass speed and direction, safety lock to protect accidental windlass deployment. Kit includes sensor and magnet.

Code	UM	€
1205154	PCS	



MAXWELL

Chain-Counter Display Panel

Backlit LCD length/chain counter display. With docking alarm and meters or feet readout. Kit includes sensor and magnet.

Code	ø mm	UM	€
1205557	60	PCS	



MAXWELL

Chain-Counters and Controls Extension Cables

Chain-counters and controls extension cables compatible with all Maxwell windlasses.

Code	L m	UM	€
1205180	6,5	PCS	
1205181	10	PCS	
1205182	15	PCS	
1205183	20	PCS	



MAXWELL

Thermal Cut Out Switches

Thermal cut-out switches for protection of the main windlass circuit. Enables the battery to be isolated when the winch is not in use.

Code	A	UM	€
1206014	40	PCS	
1206015	50	PCS	
1206017	70	PCS	
1206018	80	PCS	
1206023	135	PCS	



MAXWELL

Up-Down Switch Panel

Up-Down toggle switch panel. ABS panel with watertight boot seal.

Code	V	UM	€
1205002	12/24	PCS	



Up-Down Foot Switch

Pair Up-Down foot switches with Stainless Steel base and reinforced shockproof Plastic cover. Watertight, with sea water resistant silicon rubber. Diameter 70 mm, max load 5A.

Code	V	UM	€
1205120	12/24	PR	



Up-Down Foot S/Steel Switch

Pair Up-Down foot switches with Stainless Steel base and cover. Watertight, with sea water resistant silicon rubber. Diameter 70 mm, max load 5A.

Code	V	UM	€
1205122	12/24	PR	



Up-Down Remote Control

Handheld Up-Down windlass remote control with 3 meters extendible cable. Watertight, complete with watertight connector and mounting bracket. 12/24V Universal power supply.

Code	UM	€
1205300	PCS	



Wandering Lead Chain-Counter

Handheld chain counter remote control for windlass. With display that counts the length of eased-off chain. Watertight, with 3 meters extendible cable, waterproof connector and mounting bracket. 12/24V Universal power supply.

Code	Ref	Accessories	UM	€
1205500	Wandering Lead Chain-counter		PCS	
1205505	Chain-Counter Sensor		PCS	



Up-Down Hand Held Radio Control Chain-Counter

Radio control handheld chain counter for windlasses. It counts the length of eased-off chain without cable ties, plugs or panels. The rechargeable battery gives all the freedom of manoeuvres during the anchorage operations. IP56 Protection. Dimensions 145 x 50 x 22 mm.

Code	Ref	Accessories	UM	€
1205322	Wandering Lead Chain-counter		PCS	
1205505	Chain-Counter Sensor		PCS	



Up-Down Radio Control

Small and handy 2 or 4 channels radio control. Can command anchor winches, crabs and gangways. Wireless, complete with 12/24V receiver, both IP67 watertight.

Code	Radio Channels	UM	€
1205320	2	PCS	
1205321	4	PCS	



Up-Down Kompass Radio Control

Compact floating 8 channel radio control. Can command 2 winches and 2 bow thrusters. Complete with receiver, both IP67 waterproof. Dimensions 60 x 30 x H145 mm.

Code	Radio Channels	UM	€
1205330	8	PCS	



Chain Counter Panel

Chain counter panel, it counts the length of eased-off chain. Small and compact, can be mounted on all winches. IP56 Protected case. 12/24V Universal power supply. Dimensions 60 x 60 x 18 mm.

Code	Ref	Accessories	UM	€
1205507	Chain-Counter Panel		PCS	
1205505		Chain-Counter Sensor	PCS	



Up-Down Flybridge Chain-Counter Panel

Remote windlass control Up-Down chain counter panel, it displays the length and the speed of eased-off chain. Automatic release function and adjustable display contrast. IP56 Protection, surface or flush mount. Dimensions: 100 x 100 x 18 mm. 12/24V Universal power supply.

Code	Ref	Accessories	UM	€
1205510	Chain-Counter Panel		PCS	
1205505		Chain-Counter Sensor	PCS	



Up-Down Chain-Counter Radio Control Panel

Radio control windlass chain counter panel, it counts the length of eased-off chain without cable ties ensuring all the freedom of manoeuvres during the anchorage operations. Easy mount with simply connection on battery power. IP56 Protected case. Dimensions 100 x 100 x 18 mm.

Code	Ref	Accessories	UM	€
1205511	Chain-Counter Panel		PCS	
1205505		Chain-Counter Sensor	PCS	



Control Box (Solenoids)

Two remote control box switches in an IP56 closed container.

Code	For Motors W	Outlets	A	V	UM	€
1205112	<700	4	90	12	PCS	
1205212	<1700	3	150	12	PCS	
1205224	<1700	3	130	24	PCS	



Unimer Smart Mooring Snubber

Strong elastic material mooring snubbers that prevent damage to the boats by absorbing instant loads on mooring lines. Sold in pairs. Can be fitted to the line fast and easy whenever needed. The assembling process does not require any free end of the line. Compensation effect can be easily adjusted by adding more compensators on the same line.

Code	L mm	Line Size ø mm	UM	€
3137016	70	<16	PR	
3137018	87	<20	PR	



UNIMER

Unimer Wave Mooring Snubber

Swedish Moulded mooring snubber in EPDM Rubber with 6 rope holes. The 6 holes for the line and inlines in each end provide the easiest suspension, safe and cushioned mooring, avoiding damages to ropes and cleats, while extending your boat's life. Available in 3 sizes, fits lines with a diameter between 10 and 18 mm.

Code	L mm	Line Size ø mm	UM	€
3137008	156	10/12	PCS	
3137009	210	12/16	PCS	
3137010	335	14/18	PCS	



UNIMER

Unimer Inline Mooring Snubber

Swedish Moulded mooring snubber in almost indistructible EPDM Rubber. The 6 holes for the line and inlines in each end provide the easiest suspension, safe and cushioned mooring, avoiding damages to ropes and cleats, while extending your boat's life. Available in 3 sizes, fits lines with a diameter between 8 and 20 mm.

Code	L mm	Line Size ø mm	UM	€
3137005	156	8/10	PCS	
3137006	250	12/14	PCS	
3137007	300	16/20	PCS	



UNIMER

Unimer Classic Mooring Snubber

Unimer Classic mooring snubber in strong and indistructible EPDM Rubber, provides the easiest and cushioned mooring, avoids damages to ropes and cleats, while extending your boat's life. The length of the compensating movement can be varied by winding the line a different number of turns around the compensator (never more than 3): more turns, more compensating.

Code	L mm	Line Size ø mm	UM	€
3137001	332	10/12	PCS	
3137002	416	12/16	PCS	
3137003	520	14/18	PCS	
3137004	600	20/24	PCS	

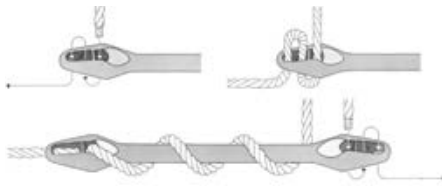

UNIMER

Unimer U-Cleat Mooring Snubber

The U-Cleat Mooring snubber features a removable locking mechanism. The U-Cleat can easily be repositioned after fitting, transferred to another line, or fitted to a line with eye splices or thimbles on both ends. Built in strong ribbed EPDM Rubber, provides the easiest and cushioned mooring, avoids damages to ropes and cleats, while extending your boat's life. The length of the compensating movement can be varied by winding the line a different number of turns around the compensator (never more than 3): more turns, more compensating.

Code	L mm	Line Size ø mm	UM	€
3137021	329	10/12	PCS	
3137022	412	12/16	PCS	
3137023	516	16/20	PCS	



UNIMER

Stainless Steel Standard Mooring Shock Absorber

Stainless Steel spring mooring shock absorbers.



Code	ø mm	L mm	Boat Size	UM	€
3136027	55	270	Up to 7 m	PCS	
3136032	62	320	Up to 8 m	PCS	
3136039	75	340	Up to 10 m	PCS	
3136043	80	470	Up to 12 m	PCS	



Stainless Steel No Squeaking Mooring Shock Absorber

No squeaking Stainless Steel spring mooring shock absorbers.



Code	Wire ø mm	L mm	Boat Size	UM	€
3136505	5	300	Up to 6 m	PCS	
3136506	6	300	Up to 8 m	PCS	
3136507	7	400	Up to 10 m	PCS	
3136509	9	470	Up to 12 m	PCS	
3136511	11	470	Up to 14 m	PCS	



From 7 to 12 Meters MPP/T Mooring Shock Absorber

Sidermarine high performance Stainless Steel and outstanding breaking load mooring shock absorbers. Corrosion resistant, they are absolutely silent thanks to the low-noise anti-friction patented inserts. The Mollaflex Bayer elastomer inserts ensure more absorbing safety in high load conditions and they continue to work even if the spring brakes, avoiding damage to the boat.



Code	Wire ø	Breaking Load	Boat Size	UM	€
3136707	7 mm	3000 Kg	7<>9 m	PCS	
3136709	9 mm	6000 Kg	9<>12 m	PCS	



From 12 to 25 Meters MPP/T Mooring Shock Absorber

Sidermarine high performance Stainless Steel and outstanding breaking load mooring shock absorbers. Corrosion resistant, they are absolutely silent thanks to the low-noise anti-friction patented inserts. The Mollaflex Bayer elastomer inserts ensure more absorbing safety in high load conditions and they continue to work even if spring the brakes, avoiding damages to the boat.



Code	Wire ø	Breaking Load	Boat Size	UM	€
3136710	10 mm	10000 Kg	12<>16 m	PCS	
3136712	12 mm	20000 Kg	16<>25 m	PCS	



From 25 to 35 Meters MPP/T Mooring Shock Absorber

Sidermarine high performance Stainless Steel and outstanding breaking load mooring shock absorbers. Corrosion resistant, they are absolutely silent thanks to the low-noise anti-friction patented inserts. The Mollaflex Bayer elastomer inserts ensure more absorbing safety in high load conditions and they continue to work even if spring the brakes, avoiding damages to the boat.



Code	Wire ø	Breaking Load	Boat Size	UM	€
3136715	15 mm	35000 Kg	25<>35 m	PCS	

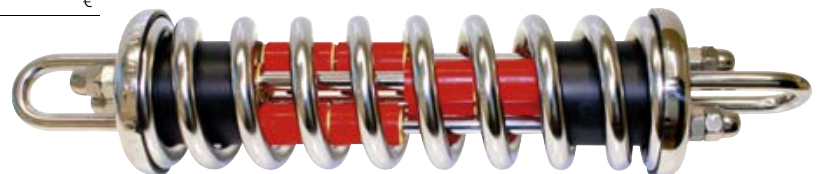

From 20 to 90 Tons MPP K Mooring Shock Absorber

Sidermarine high performance Stainless Steel and outstanding breaking load mooring shock absorbers. Corrosion resistant, they are absolutely silent thanks to the low-noise anti-friction patented inserts. It doesn't present any welded component. The Mollaflex Bayer elastomer inserts ensure more absorbing safety in high load conditions and they continue to work even if the spring brakes, avoiding damages to the boat.



Code	Boat Size	UM	€
3136755	From 20 to 90 Tons	PCS	



Classic White Line

3-strand medium tenacity Polyester dock and anchor line.
Non floating. daN= breaking strength in Kg

Code	ø mm	daN	m	UM	€
310008200	8	600	200	PCK	
3100010200	10	1000	200	PCK	
3100012200	12	1350	200	PCK	
3100014100	14	1900	100	PCK	
3100016100	16	2400	100	PCK	
3100018100	18	3000	100	PCK	
3100020100	20	3800	100	PCK	
3100022100	22	4500	100	PCK	
3100024100	24	5400	100	PCK	
3100026100	26	6200	100	PCK	
3100028100	28	7200	100	PCK	
3100030100	30	8250	100	PCK	
3100032100	32	9200	100	PCK	
3100036100	36	11400	100	PCK	
3100040100	40	12800	100	PCK	



Classic Black Line

3-strand medium tenacity Polyester dock and anchor line.
Non floating. daN= breaking strength in Kg

Code	ø mm	daN	m	UM	€
3100108200	8	600	200	PCK	
3100110200	10	1000	200	PCK	
3100112200	12	1350	200	PCK	
3100114100	14	1900	100	PCK	
3100116100	16	2400	100	PCK	
3100118100	18	3000	100	PCK	
3100120100	20	3800	100	PCK	
3100122100	22	4500	100	PCK	
3100124100	24	5400	100	PCK	
3100126100	26	6200	100	PCK	
3100128100	28	7200	100	PCK	
3100130100	30	8250	100	PCK	
3100132100	32	9200	100	PCK	
3100136100	36	11400	100	PCK	
3100140100	40	12800	100	PCK	



Americana White Line

3-strand double spun, high quality, abrasion resistant and high tenacity Polyester dock and anchor line.
Non floating. daN= breaking strength in Kg



Code	ø mm	daN	m	UM	€
3100610200	10	1860	200	PCK	
3100612200	12	2700	200	PCK	
3100614150	14	3700	150	PCK	
3100616100	16	4800	100	PCK	
3100618100	18	6300	100	PCK	
3100620100	20	7500	100	PCK	
3100622100	22	9000	100	PCK	
3100624100	24	11400	100	PCK	
3100626100	26	12600	100	PCK	
3100628100	28	14000	100	PCK	
3100630100	30	16500	100	PCK	
3100632100	32	18400	100	PCK	
3100636100	36	24500	100	PCK	
3100640100	40	28900	100	PCK	



Americana Blue Navy Line

3-strand double spun, high quality, abrasion resistant and high tenacity Polyester dock and anchor line.
Non floating. daN= breaking strength in Kg



Code	ø mm	daN	m	UM	€
3102010200	10	1860	200	PCK	
3102012200	12	2700	200	PCK	
3102014150	14	3700	150	PCK	
3102016100	16	4800	100	PCK	
3102018100	18	6300	100	PCK	
3102020100	20	7500	100	PCK	
3102022100	22	9000	100	PCK	
3102024100	24	11400	100	PCK	
3102026100	26	12600	100	PCK	
3102028100	28	14000	100	PCK	
3102030100	30	16500	100	PCK	
3102032100	32	18400	100	PCK	
3102036100	36	24500	100	PCK	
3102040100	40	28900	100	PCK	



Americana Red Wine Line

3-strand double spun, high quality, abrasion resistant and high tenacity Polyester dock and anchor line.
Non floating. daN= breaking strength in Kg



Code	ø mm	daN	m	UM	€
3102110200	10	1860	200	PCK	
3102112200	12	2700	200	PCK	
3102114150	14	3700	150	PCK	
3102116100	16	4800	100	PCK	
3102118100	18	6300	100	PCK	
3102120100	20	7500	100	PCK	
3102122100	22	9000	100	PCK	
3102124100	24	11400	100	PCK	
3102126100	26	12600	100	PCK	
3102128100	28	14000	100	PCK	



Americana Gold Line

3-strand double spun, high quality, abrasion resistant and high tenacity Polyester dock and anchor line.
Non floating. daN= breaking strength in Kg



Code	ø mm	daN	m	UM	€
3102310200	10	1860	200	PCK	
3102312200	12	2700	200	PCK	
3102314150	14	3700	150	PCK	
3102316100	16	4800	100	PCK	
3102318100	18	6300	100	PCK	
3102320100	20	7500	100	PCK	
3102322100	22	9000	100	PCK	
3102324100	24	11400	100	PCK	
3102326100	26	12600	100	PCK	
3102328100	28	14000	100	PCK	



Squareline Evolution White Line

12-strand double spun high quality, abrasion-resistant high tenacity Polyester dock and anchor braid line. Soft handling, no kinking. Non floating. daN= breaking strength in Kg



Code	ø mm	daN	m	UM	€
3100712200	12	2600	200	PCK	
3100714150	14	3100	150	PCK	
3100716100	16	3700	100	PCK	
3100718100	18	4500	100	PCK	
3100720100	20	5000	100	PCK	
3100722100	22	5500	100	PCK	
3100724100	24	6500	100	PCK	



Squareline Evolution Blue Line

12-strand double spun high quality, abrasion-resistant high tenacity Polyester dock and anchor braid line. Soft handling, no kinking. Non floating. daN= breaking strength in Kg



Code	ø mm	daN	m	UM	€
3102712200	12	2600	200	PCK	
3102714150	14	3100	150	PCK	
3102716100	16	3700	100	PCK	
3102718100	18	4500	100	PCK	
3102720100	20	5000	100	PCK	
3102722100	22	5500	100	PCK	
3102724100	24	6500	100	PCK	



White Braid Mooring Line

16 plait double braid out of Polyester dock and anchor braid line. Extremely strong with the highest flexibility assures high resiliency. Easy to splice. Non floating. daN = breaking strength in Kg.



Code	ø mm	daN	m	UM	€
3100450200	10	1600	200	PCK	
3100452200	12	2000	200	PCK	
3100454150	14	3000	150	PCK	
3100456100	16	4000	100	PCK	
3100458100	18	4500	100	PCK	
3100460100	20	5000	100	PCK	



Black & White Braid Mooring Line

16 plait colour coded double braid out of Polyester dock and anchor braid line. Easy to handle, extremely tensile and chafe resistant assures high resiliency. Non floating. daN = breaking strength in Kg.



Code	ø mm	daN	m	UM	€
3100308200	8	1200	200	PCK	
3100310200	10	1600	200	PCK	
3100312200	12	2000	200	PCK	
3100314150	14	3000	150	PCK	
3100316100	16	4000	100	PCK	
3100318100	18	4500	100	PCK	
3100320100	20	5000	100	PCK	



Blue Navy Braid Mooring Line

16 plait double braid out of Polyester dock and anchor braid line. Extremely strong with the highest flexibility assures high resiliency. Easy to splice. Non floating. daN = breaking strength in Kg.



Code	ø mm	daN	m	UM	€
3100430200	10	1600	200	PCK	
3100432200	12	2000	200	PCK	
3100434150	14	3000	150	PCK	
3100436100	16	4000	100	PCK	
3100438100	18	4500	100	PCK	
3100440100	20	5000	100	PCK	
3100442100	22	5500	100	PCK	
3100444100	24	6500	100	PCK	



Black Braid Mooring Line

16 plait double braid out of Polyester dock and anchor braid line. Extremely strong with the highest flexibility assures high resiliency. Easy to splice. Non floating. daN = breaking strength in Kg.



Code	ø mm	daN	m	UM	€
3100410200	10	1600	200	PCK	
3100412200	12	2000	200	PCK	
3100414150	14	3000	150	PCK	
3100416100	16	4000	100	PCK	
3100418100	18	4500	100	PCK	
3100420100	20	5000	100	PCK	
3100422100	22	5500	100	PCK	
3100424100	24	6500	100	PCK	



Steel Grey Braid Mooring Line

16 plait double braid out of Polyester dock and anchor braid line. Extremely strong with the highest flexibility assures high resiliency. Easy to splice. Non floating. daN = breaking strength in Kg.



Code	ø mm	daN	m	UM	€
3100332200	12	2000	200	PCK	
3100334150	14	3000	150	PCK	
3100336100	16	4000	100	PCK	
3100338100	18	4500	100	PCK	
3100340100	20	5000	100	PCK	
3100342100	22	5500	100	PCK	
3100344100	24	6500	100	PCK	



Classic Braid Mooring Line

16 plait double braid out of Polyester dock and anchor braid line. Extremely strong with the highest flexibility assures high resiliency. Easy to splice. Non floating. daN = breaking strength in Kg.



Code	ø mm	daN	m	UM	€
3100352200	12	2000	200	PCK	
3100354150	14	3000	150	PCK	
3100356100	16	4000	100	PCK	
3100358100	18	4500	100	PCK	
3100360100	20	5000	100	PCK	
3100362100	22	5500	100	PCK	
3100364100	24	6500	100	PCK	





Liros Polyamide Rope

High-stretch (<20%) and very high breaking strength classic dock and anchor line. Can be used even without shock absorbers. Abrasion and UV resistant heat-set high-tenacity 3 strand Polyamide, very easy to splice. Meets DIN83330/EN696 rules. Non floating.

Code	ø mm	Colour	daN	m	UM	€
3103008200	8	WHITE	1440	200	PCK	
3103010200	10	WHITE	2400	200	PCK	
3103012200	12	WHITE	3300	200	PCK	
3103014150	14	WHITE	4400	150	PCK	
3103016100	16	WHITE	5600	100	PCK	
3103018100	18	WHITE	7000	100	PCK	
3103020100	20	WHITE	8140	100	PCK	
3103022100	22	WHITE	9800	100	PCK	
3103024100	24	WHITE	11800	100	PCK	
3103030100	30	WHITE	17400	100	PCK	
3103108200	8	BLUE NAVY	1440	200	PCK	
3103110200	10	BLUE NAVY	2400	200	PCK	
3103112200	12	BLUE NAVY	3300	200	PCK	
3103114150	14	BLUE NAVY	4400	150	PCK	
3103116100	16	BLUE NAVY	5600	100	PCK	
3103118100	18	BLUE NAVY	7000	100	PCK	
3103120100	20	BLUE NAVY	8140	100	PCK	
3103122100	22	BLUE NAVY	9800	100	PCK	
3103124100	24	BLUE NAVY	11800	100	PCK	
3103130100	30	BLUE NAVY	17400	100	PCK	



ANCHORING/MOORING/FENDERS BUOYS

Liros Lirolen

Very soft and flexible multi-purpose floating detachable dock and anchor line. Suitable also for towing. Stays pliable even after extensive usage. Easy to splice heat-set multifilament 3 strand Polypropilene. Stretch <15%. Meets DIN83334/EN699 rules.

Code	ø mm	Colour	daN	m	UM	€
3103308200	8	WHITE	1040	200	PCK	
3103310200	10	WHITE	1600	200	PCK	
3103312200	12	WHITE	2200	200	PCK	
3103314150	14	WHITE	3000	150	PCK	
3103316100	16	WHITE	3700	100	PCK	
3103318100	18	WHITE	4700	100	PCK	
3103320100	20	WHITE	5700	100	PCK	
3103408200	8	BLUE	1040	200	PCK	
3103410200	10	BLUE	1600	200	PCK	
3103412200	12	BLUE	2200	200	PCK	
3103414150	14	BLUE	3000	150	PCK	
3103416100	16	BLUE	3700	100	PCK	
3103418100	18	BLUE	4700	100	PCK	
3103420100	20	BLUE	5700	100	PCK	
3103808200	8	BLACK	1040	200	PCK	
3103810200	10	BLACK	1600	200	PCK	
3103812200	12	BLACK	2200	200	PCK	
3103814150	14	BLACK	3000	150	PCK	
3103816100	16	BLACK	3700	100	PCK	
3103818100	18	BLACK	4700	100	PCK	
3103820100	20	BLACK	5700	100	PCK	

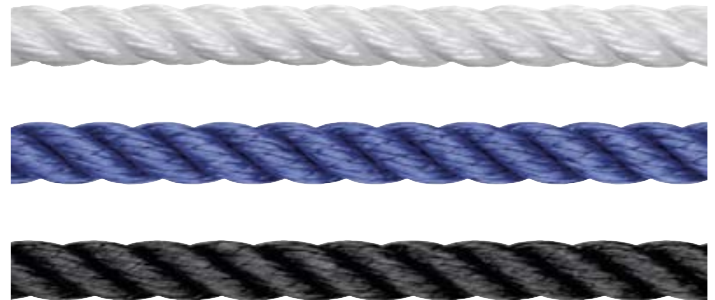

Liros 3-Strand Tradition Classic

Dock and anchor line for all type of classic and old sailing ships, can be used also as halyard or sheet. Superior quality, durable, high abrasion resistant, easy to handle, high grip and extra look. 3 Strand matt Polyester yarn. Working stretch <17%. Non floating.

Code	ø mm	daN	m	UM	€
3103606200	6	350	200	PCK	
3103608200	8	730	200	PCK	
3103610200	10	1100	200	PCK	
3103612200	12	1300	200	PCK	
3103614150	14	1700	150	PCK	
3103616100	16	2200	100	PCK	
3103618100	18	3500	100	PCK	
3103620100	20	4900	100	PCK	





Liros Handy Elastic

Superior quality, soft, easy handling and easy splicing dock and anchor line. High breaking strength, high-stretch (<20%), extremely abrasion resistant, can be used even without shock absorbers. High-elastic braided Polyamide core. High-tenacity UV resistant Polyamide cover. Non Floating.

Code	ø mm	Colour	daN	m	UM	€
3102808200	8	BLUE NAVY	1600	200	PCK	
3102810200	10	BLUE NAVY	2500	200	PCK	
3102812200	12	BLUE NAVY	3900	200	PCK	
3102814150	14	BLUE NAVY	4800	150	PCK	
3102816100	16	BLUE NAVY	6000	100	PCK	
3102818100	18	BLUE NAVY	8500	100	PCK	
3102820100	20	BLUE NAVY	9900	100	PCK	
3102822100	22	BLUE NAVY	10600	100	PCK	
3102824100	24	BLUE NAVY	12000	100	PCK	
3102908200	8	BLACK	1600	200	PCK	
3102910200	10	BLACK	2500	200	PCK	
3102912200	12	BLACK	3900	200	PCK	
3102914150	14	BLACK	4800	150	PCK	
3102916100	16	BLACK	6000	100	PCK	
3102918100	18	BLACK	8500	100	PCK	
3102920100	20	BLACK	9900	100	PCK	
3102922100	22	BLACK	10600	100	PCK	
3102924100	24	BLACK	12000	100	PCK	



Liros Porto

Superior quality extremely abrasion resistant, very easy handling and easy splicing dock and anchor line. Compact and high strength line, will not stiffen up in time. High-tenacity braided Polyester core. UV resistant high-twisted Polyester cover. Working stretch <15%. Non floating.

Code	ø mm	Colour	daN	m	UM	€
3102510200	10	BLUE NAVY	2300	200	PCK	
3102512200	12	BLUE NAVY	2900	200	PCK	
3102514150	14	BLUE NAVY	3700	150	PCK	
3102516100	16	BLUE NAVY	4900	100	PCK	
3102518100	18	BLUE NAVY	5300	100	PCK	
3102520100	20	BLUE NAVY	6300	100	PCK	
3102522100	22	BLUE NAVY	8900	100	PCK	
3102524100	24	BLUE NAVY	9600	100	PCK	
3102410200	10	BLACK	2300	200	PCK	
3102412200	12	BLACK	2900	200	PCK	
3102414150	14	BLACK	3700	150	PCK	
3102416100	16	BLACK	4900	100	PCK	
3102418100	18	BLACK	5300	100	PCK	
3102420100	20	BLACK	6300	100	PCK	
3102422100	22	BLACK	8900	100	PCK	
3102424100	24	BLACK	9600	100	PCK	



Liros Super Yacht Mooring

Dock and anchor line for superyachts up to 90 meters. The flexible high-tenacity braided Polyester core provides the best in safety, while the 24 plaited Polyester cover delivers premium comfort, easy handling and easy splicing. Working stretch <15%. Non floating.

Code	ø mm	Colour	daN	Boat Size m	m	UM	€
3100824100	24	BLUE NAVY	11500	Up to 30	100	PCK	
3100828100	28	BLUE NAVY	15900	Up to 40	100	PCK	
3100832100	32	BLUE NAVY	19800	Up to 50	100	PCK	
3100836100	36	BLUE NAVY	26000	Up to 60	100	PCK	
3100840100	40	BLUE NAVY	32800	Up to 65	100	PCK	
3100844100	44	BLUE NAVY	38500	Up to 70	100	PCK	
3100848100	48	BLUE NAVY	46000	Up to 80	100	PCK	
3100852100	52	BLUE NAVY	53500	Up to 90	100	PCK	
3100924100	24	BLACK	11500	Up to 30	100	PCK	
3100928100	28	BLACK	15900	Up to 40	100	PCK	
3100932100	32	BLACK	19800	Up to 50	100	PCK	
3100936100	36	BLACK	26000	Up to 60	100	PCK	
3100940100	40	BLACK	32800	Up to 65	100	PCK	
3100944100	44	BLACK	38500	Up to 70	100	PCK	
3100948100	48	BLACK	46000	Up to 80	100	PCK	
3100952100	52	BLACK	53500	Up to 90	100	PCK	



MOORING LINES FOR SUPER YACHTS

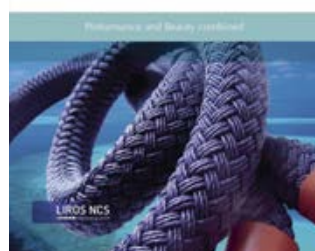

Multipurpose Braid

Stabilized multi-filament multipurpose braid line. Features: 8 plait 100% high quality Polyethylene. daN = breaking strength in Kg.

Code	ø mm	daN	m	UM	€
3103502100	2	90	100	PCK	
3103503100	3	130	100	PCK	
3103504100	4	220	100	PCK	
3103505100	5	340	100	PCK	
3103506100	6	500	100	PCK	



Lapo Braid Line

16 Plait color coded Polyester multipurpose economical dock and anchor line. Non floating. daN= breaking strength in Kg.

Code	ø mm	daN	m	UM	€
3101504500	4	190	500	PCK	
3101505400	5	275	400	PCK	
3101506200	6	500	200	PCK	
3101508200	8	840	200	PCK	
3101510200	10	1200	200	PCK	
3101512200	12	1400	200	PCK	
3101514100	14	1600	100	PCK	



Liros Polyamide Braid

Abrasion resistant, flexible and elastic (<15%) multipurpose braid line. Features: 8 Plaited UV resistant high-tenacity Polyamide. daN = breaking strength in Kg.



Code	ø mm	daN	m	UM	€
3104502100	2	100	100	PCK	
3104503100	3	180	100	PCK	
3104505100	5	550	100	PCK	
3104506100	6	850	100	PCK	



Floating Orange Braid

Multi-filament multipurpose braid line for lifelines, handrails, temporary moorings etc. Soft and light, it floats, it doesn't absorb humidity. Construction: 3 plait, 100% Polyethylene. daN= breaking load in Kg.

Code	ø mm	daN	m	UM	€
3101006200	6	300	200	PCK	
3101008200	8	400	200	PCK	
3101010200	10	500	200	PCK	
3101012200	12	800	200	PCK	
3101014100	14	1100	100	PCK	
3101016100	16	1400	100	PCK	
3101018100	18	1800	100	PCK	
3101020100	20	2200	100	PCK	



Floating Black Braid

Multi-filament multipurpose braid line for lifelines, handrails, temporary moorings etc. Soft and light, it floats, it doesn't absorb humidity. Construction: 3 plait, 100% Polyethylene. daN= breaking load in Kg.

Code	ø mm	daN	m	UM	€
3101206200	6	300	200	PCK	
3101208200	8	400	200	PCK	
3101210200	10	500	200	PCK	
3101212200	12	800	200	PCK	
3101214100	14	1100	100	PCK	
3101216100	16	1400	100	PCK	
3101218100	18	1800	100	PCK	
3101220100	20	2200	100	PCK	



Floating Grey Braid

Multi-filament multipurpose braid line ideal for inflatables and tenders. Soft and light, it floats, it doesn't absorb humidity. Construction: 16 plaits, 100% UV stabilized Polyethylene. daN= breaking load in Kg.

Code	ø mm	daN	m	UM	€
3101308200	8	700	200	PCK	
3101310200	10	1000	200	PCK	
3101312200	12	1300	200	PCK	
3101314150	14	1800	150	PCK	
3101316100	16	2000	100	PCK	



Sternroller Mooring Reels

Quick and safe handy mooring system composed by flat high-resistance belt line and heavy duty 316 Stainless Steel mooring reel. Universal rail tubing or wall mount.



Code	Belt L	Reel ø mm	Breaking Load Kg	UM	€
3137132	25 mm x 30 m	290	2000	PCS	
3137153	35 mm x 50 m	380	4000	PCS	



Nawa Mooring Reels

Quick and safe handy mooring system composed by: - Soft, flat high resistance belt line - Heavy duty 316 Stainless Steel mooring reel with an adjustable friction brake - Universal rail tubing or wall mount.



Code	Belt L	Reel ø mm	Breaking Load Kg	UM	€
3137103	25 mm x 32 m	360	2000	PCS	
3137105	25 mm x 50 m	420	2000	PCS	



Eyed Lapo Braid Line

16 Plait color coded Polyester multipurpose economical dock and anchor braid with thimble. Non floating.

Code	ø mm	Line L m	UM	€
3101538	8	30	PCK	
3101540	10	30	PCK	
3101541	10	50	PCK	
3101542	12	30	PCK	
3101543	12	50	PCK	



White Mooring Line with Thimble

Double braid Polyester mooring line with spliced Stainless Steel thimble. Non floating.

Code	ø mm	Line L m	UM	€
3101459	10	6	PCK	
3101461	12	8	PCK	
3101463	14	10	PCK	
3101465	16	12	PCK	
3101468	20	15	PCK	
3101469	24	15	PCK	



Black Mooring Line with Thimble

Double braid Polyester mooring line with spliced Stainless Steel thimble. Non floating.

Code	ø mm	Line L m	UM	€
3101439	10	6	PCK	
3101441	12	8	PCK	
3101443	14	10	PCK	
3101445	16	12	PCK	
3101448	20	15	PCK	
3101449	24	15	PCK	



Blue Navy Mooring Line with Thimble

Double braid Polyester mooring line with spliced Stainless Steel thimble. Non floating.

Code	ø mm	Line L m	UM	€
3101419	10	6	PCK	
3101421	12	8	PCK	
3101423	14	10	PCK	
3101425	16	12	PCK	
3101428	20	15	PCK	
3101429	24	15	PCK	



Pre-Spliced White Dock Line

Ready to use pre-spliced double braid Polyester dock line. Non floating.

Code	ø mm	Line L m	UM	€
3101480	10	6	PCK	
3101481	12	8	PCK	
3101483	14	10	PCK	
3101485	16	12	PCK	
3101487	20	15	PCK	
3101488	24	15	PCK	



Pre-Spliced Black Dock Line

Ready to use pre-spliced double braid Polyester dock line. Non floating.

Code	ø mm	Line L m	UM	€
3101450	10	6	PCK	
3101451	12	8	PCK	
3101453	14	10	PCK	
3101455	16	12	PCK	
3101457	20	15	PCK	
3101458	24	15	PCK	



Pre-Spliced Blue Navy Dock Line

Ready to use pre-spliced double braid Polyester dock line. Non floating.

Code	ø mm	Line L m	UM	€
3101430	10	6	PCK	
3101431	12	8	PCK	
3101433	14	10	PCK	
3101435	16	12	PCK	
3101437	20	15	PCK	
3101438	24	15	PCK	





Liros Mooring Handy Elastic Protect

Ready to use pre-spliced dock braid line L40 with abrasion resistant Polyester protection cover. Superior quality, soft, easy handling, with high breaking strength, high-stretch (<20%), can be used even without shock absorbers. High-elastic braided Polyamide core. High-tenacity UV resistant Polyamide cover. Non floating. daN= breaking strength in Kg

Code	ø mm	daN	Line L m	UM	€
3102610	10	2000	6	PCK	
3102611	10	2000	10	PCK	
3102612	12	3120	10	PCK	
3102613	12	3120	15	PCK	
3102614	14	3840	10	PCK	
3102615	14	3840	15	PCK	
3102616	16	4800	10	PCK	
3102617	16	4800	15	PCK	
3102618	18	6800	10	PCK	
3102619	18	6800	15	PCK	



- MOORING AND ANCHORING CUSTOM LINE READY BRAIDS -

Custom Dock Line Steel Grey with Eye

Ready to use dock braid line with hand pre-spliced, seamed and finished eye. Supplied with hand sewed and finished marine grade leather eye cover or with naked eye. Also the end terminal is hand finished and sewed to avoid imperfections. Strong and soft, made of 16 plaited high tenacity Polyester, with maximum abrasion resistance sheath. Non floating. daN= breaking strength in Kg

Code	ø mm	daN	Eye Cover	Eye L m	Line L m	UM	€
3101618	24	11800	No	0,75	16	PCK	
3101620	24	11800	No	0,75	20	PCK	
3101622	24	11800	BLACK Leather	0,75	16	PCK	
3101624	24	11800	BLACK Leather	0,75	20	PCK	
3101626	28	16100	No	0,75	16	PCK	
3101628	28	16100	No	0,75	20	PCK	
3101630	28	16100	BLACK Leather	0,75	16	PCK	
3101632	28	16100	BLACK Leather	0,75	20	PCK	
3101634	32	20900	No	1,00	16	PCK	
3101636	32	20900	No	1,00	20	PCK	
3101638	32	20900	BLACK Leather	1,00	16	PCK	
3101640	32	20900	BLACK Leather	1,00	20	PCK	
3101642	36	24500	No	1,00	16	PCK	
3101644	36	24500	No	1,00	20	PCK	
3101646	36	24500	BLACK Leather	1,00	16	PCK	
3101648	36	24500	BLACK Leather	1,00	20	PCK	



Custom Dock Line Classic with Eye

Ready to use dock braid line with hand pre-spliced, seamed and finished eye. Supplied with hand sewed and finished marine grade leather eye cover or with naked eye. Also the end terminal is hand finished and sewed to avoid imperfections. Strong and soft, made of 16 plaited high tenacity Polyester, with maximum abrasion resistance sheath. Non floating. daN= breaking strength in Kg

Code	ø mm	daN	Eye Cover	Eye L m	Line L m	UM	€
3101650	24	11800	No	0,75	16	PCK	
3101652	24	11800	No	0,75	20	PCK	
3101656	24	11800	BROWN Leather	0,75	16	PCK	
3101658	24	11800	BROWN Leather	0,75	20	PCK	
3101662	28	16100	No	0,75	16	PCK	
3101664	28	16100	No	0,75	20	PCK	
3101668	28	16100	BROWN Leather	0,75	16	PCK	
3101670	28	16100	BROWN Leather	0,75	20	PCK	
3101674	32	20900	No	1,00	16	PCK	
3101676	32	20900	No	1,00	20	PCK	
3101680	32	20900	BROWN Leather	1,00	16	PCK	
3101682	32	20900	BROWN Leather	1,00	20	PCK	
3101686	36	24500	No	1,00	16	PCK	
3101688	36	24500	No	1,00	20	PCK	
3101692	36	24500	BROWN Leather	1,00	16	PCK	
3101694	36	24500	BROWN Leather	1,00	20	PCK	



Custom Dock Line Blue Navy with Eye

Ready to use dock braid line with hand pre-spliced, seamed and finished eye. Supplied with naked eye or with Dyneema sewed and finished marine grade leather eye cover. Also the end terminal is hand finished and sewed to avoid imperfections. Strong and soft, made of 16 plaited high tenacity Polyester, with maximum abrasion resistance sheath. Non floating. daN= breaking strength in Kg

Code	ø mm	daN	Eye Cover	Eye L m	Line L m	UM	€
3101812	24	11800	No	0,75	16	PCK	
3101814	24	11800	No	0,75	20	PCK	
3101818	24	11800	BLACK Leather	0,75	16	PCK	
3101820	24	11800	BLACK Leather	0,75	20	PCK	
3101824	24	11800	BROWN Leather	0,75	16	PCK	
3101826	24	11800	BROWN Leather	0,75	20	PCK	
3101830	28	16100	No	0,75	16	PCK	
3101832	28	16100	No	0,75	20	PCK	
3101836	28	16100	BLACK Leather	0,75	16	PCK	
3101838	28	16100	BLACK Leather	0,75	20	PCK	
3101842	28	16100	BROWN Leather	0,75	16	PCK	
3101844	28	16100	BROWN Leather	0,75	20	PCK	
3101848	32	20900	No	1,00	16	PCK	
3101850	32	20900	No	1,00	20	PCK	
3101854	32	20900	BLACK Leather	1,00	16	PCK	
3101856	32	20900	BLACK Leather	1,00	20	PCK	
3101860	32	20900	BROWN Leather	1,00	16	PCK	
3101862	32	20900	BROWN Leather	1,00	20	PCK	
3101866	36	24500	No	1,00	16	PCK	
3101868	36	24500	No	1,00	20	PCK	
3101872	36	24500	BLACK Leather	1,00	16	PCK	
3101874	36	24500	BLACK Leather	1,00	20	PCK	
3101878	36	24500	BROWN Leather	1,00	16	PCK	
3101880	36	24500	BROWN Leather	1,00	20	PCK	
3101884	40	28900	No	1,20	20	PCK	
3101886	40	28900	No	1,20	24	PCK	
3101888	40	28900	BLACK Leather	1,20	20	PCK	
3101890	40	28900	BLACK Leather	1,20	24	PCK	
3101892	40	28900	BROWN Leather	1,20	20	PCK	
3101894	40	28900	BROWN Leather	1,20	24	PCK	



Marco Senvenuti

Custom Dock Line Black with Eye

Ready to use dock braid line with hand pre-spliced, seamed and finished eye. Supplied simple or with marine-treated leather cover and Dyneema stitching. Strong and soft, made of 16 plaited high tenacity Polyester, with maximum abrasion resistance sheath. Non floating. daN= breaking strength in Kg

Code	ø mm	daN	Eye Cover	Eye L m	Line L m	UM	€
3101912	24	11800	No	0,75	16	PCK	
3101914	24	11800	No	0,75	20	PCK	
3101918	24	11800	BLACK Leather	0,75	16	PCK	
3101920	24	11800	BLACK Leather	0,75	20	PCK	
3101924	24	11800	BROWN Leather	0,75	16	PCK	
3101926	24	11800	BROWN Leather	0,75	20	PCK	
3101930	28	16100	No	0,75	16	PCK	
3101932	28	16100	No	0,75	20	PCK	
3101936	28	16100	BLACK Leather	0,75	16	PCK	
3101938	28	16100	BLACK Leather	0,75	20	PCK	
3101942	28	16100	BROWN Leather	0,75	16	PCK	
3101944	28	16100	BROWN Leather	0,75	20	PCK	
3101948	32	20900	No	1,00	16	PCK	
3101950	32	20900	No	1,00	20	PCK	
3101954	32	20900	BLACK Leather	1,00	16	PCK	
3101956	32	20900	BLACK Leather	1,00	20	PCK	
3101960	32	20900	BROWN Leather	1,00	16	PCK	
3101962	32	20900	BROWN Leather	1,00	20	PCK	
3101966	36	24500	No	1,00	16	PCK	
3101968	36	24500	No	1,00	20	PCK	
3101972	36	24500	BLACK Leather	1,00	16	PCK	
3101974	36	24500	BLACK Leather	1,00	20	PCK	
3101978	36	24500	BROWN Leather	1,00	16	PCK	
3101980	36	24500	BROWN Leather	1,00	20	PCK	
3101984	40	28900	No	1,20	20	PCK	
3101986	40	28900	No	1,20	24	PCK	
3101988	40	28900	BLACK Leather	1,20	20	PCK	
3101990	40	28900	BLACK Leather	1,20	24	PCK	
3101992	40	28900	BROWN Leather	1,20	20	PCK	
3101994	40	28900	BROWN Leather	1,20	24	PCK	



Marco Senvenuti

Custom Dock Line Blue Navy with Thimble

Ready to use dock braid line with hand pre-spliced and finished Stainless Steel thimble. Also the end terminal is hand finished and sewed to avoid imperfections. Strong and soft, made of 16 plaited high tenacity Polyester, with maximum abrasion resistance sheath. Non floating. daN= breaking strength in Kg

Code	ø mm	daN	Length m	UM	€
3101754	24	11800	16	PCK	
3101756	24	11800	20	PCK	
3101760	28	16100	16	PCK	
3101762	28	16100	20	PCK	
3101766	32	20900	16	PCK	
3101768	32	20900	20	PCK	



Custom Dock Line Black with Thimble

Ready to use dock braid line with hand pre-spliced and finished Stainless Steel thimble. Also the end terminal is hand finished and sewed to avoid imperfections. Strong and soft, made of 16 plaited high tenacity Polyester, with maximum abrasion resistance sheath. Non floating. daN= breaking strength in Kg

Code	ø mm	daN	Length m	UM	€
3101778	24	11800	16	PCK	
3101780	24	11800	20	PCK	
3101784	28	16100	16	PCK	
3101786	28	16100	20	PCK	
3101790	32	20900	16	PCK	
3101792	32	20900	20	PCK	



Custom Dock Line Steel Grey with Thimble

Ready to use dock braid line with hand pre-spliced and finished Stainless Steel thimble. Also the end terminal is hand finished and sewed to avoid imperfections. Strong and soft, made of 16 plaited high tenacity Polyester, with maximum abrasion resistance sheath. Non floating. daN= breaking strength in Kg

Code	ø mm	daN	Length m	UM	€
3101714	24	11800	16	PCK	
3101716	24	11800	20	PCK	
3101720	28	16100	16	PCK	
3101722	28	16100	20	PCK	
3101726	32	20900	16	PCK	
3101728	32	20900	20	PCK	

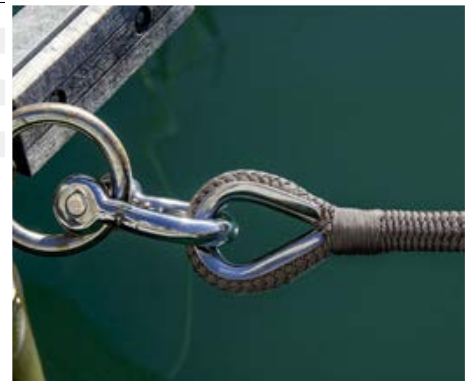

Custom Dock Line Classic with Thimble

Ready to use dock braid line with hand pre-spliced and finished Stainless Steel thimble. Also the end terminal is hand finished and sewed to avoid imperfections. Strong and soft, made of 16 plaited high tenacity Polyester, with maximum abrasion resistance sheath. Non floating. daN= breaking strength in Kg

Code	ø mm	daN	Length m	UM	€
3101730	24	11800	16	PCK	
3101732	24	11800	20	PCK	
3101736	28	16100	16	PCK	
3101738	28	16100	20	PCK	
3101742	32	20900	16	PCK	
3101744	32	20900	20	PCK	

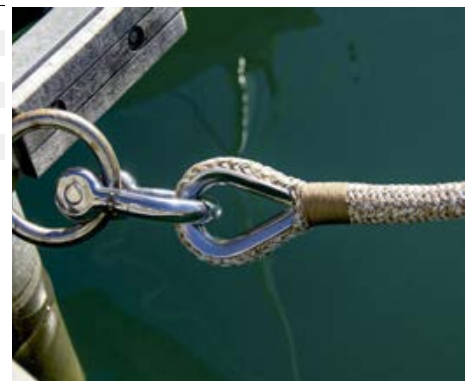

Fendress Rope Cover

Universal (from 14 to 32mm) UV resistant and durable Acrylic Rope Covers. Manufactured from the same fabric used for soft and sturdy Fendress fender covers. Protect the ropes from rubbing wear and from weathering, while matching the same colors of the fender covers. Heavy-duty easy to mount Velcro closing.

Code	Colour	Line ø mm	Length cm	UM	€
3135004	BLUE NAVY	14<>32	50	PCS	
3135005	BLUE NAVY	14<>32	100	PCS	
3135004BK	BLACK	14<>32	50	PCS	
3135005BK	BLACK	14<>32	100	PCS	
3135004BR	BLUE ROYAL	14<>32	50	PCS	
3135005BR	BLUE ROYAL	14<>32	100	PCS	
3135004SA	SAND	14<>32	50	PCS	
3135005SA	SAND	14<>32	100	PCS	
3135004WN	WINE	14<>32	50	PCS	
3135005WN	WINE	14<>32	100	PCS	



Fendress

Navishell Rope Cover

Woven acrylic fabric rope covers. Water repellent and UV rays resistant, this fabric guarantees a high level of colour fastness, 3 year non-fading guarantee. Protect the ropes from rubbing wear and from weathering. Velcro heavy-duty easy to mount closing.

Code	Colour	Line ø mm	Length cm	UM	€
3840037	BLUE NAVY	12<>26	50	PCS	
3840038	GREY	12<>26	50	PCS	



NAVISHELL

Spiroll Rope Cover

UV resistant and durable Polyurethane rope covers. Easy mounted/wrapped around the rope, a special technique enables the cover to automatically wrap around ropes, providing a perfect fit. It also reduces "squeaking" from the mooring cleat.

Code	Line ø mm	Length cm	UM	€
3135120	8 - 16	40	PCS	
3135122	16 - 25	60	PCS	



WATERLINE DESIGN

Mooring Belts

Abrasion resistant mooring belts with very high breaking load (11800 Kg). Ideal for mooring points where the rope could be damaged due to abrasion. Easy to use, they allow fast mooring with eye splice.

Code	L cm	UM	€
3136601	125	PCS	
3136602	200	PCS	



Doppel Marine

Mooring Mouse Prohibitor

Handy and reliable reinforced Plastic mooring mouse prohibitor for mooring lines from 10 to 30 mm. Easy and quick mount thanks to special multi-size adaptor and magnetic lock. Easy fixing of the disk on the desired position.

Code	UM	€
3137115	PCS	



Stainless Steel Hollow Fids

Stainless Steel hollow fids with wood handle used to gently open the strands of lines.

Code	L cm	UM	€
5830701	17,5	PCS	
5830702	26,5	PCS	



Splicing Set

Stainless Steel 4 pieces needle splicing kit.

Needles length mm: 120/140/180/220.

Respective diameters mm: 5/7/9/12.

Code	UM	€
3191000	PCK	



Liros Rigger Bag Splicing Kit

Rigger bag splicing kit with all splicing tools and accessories needed to work on all known ropes. Perfect for both professional and do-it yourself users.

Code	UM	€
3191006	PCK	



Fusion Cutter

220V 60W electric rope cutter for rope and braid heat cutting. Suitable also for sails, awnings, belts, tapes and synthetic canvas cutting.

Code	Ref	UM	€
3190001	Rope Cutter	PCS	
3190002	Replacement Blade	PCS	



Pro Fusion Cutter

220V - 120W Professional continuous duty electric rope cutter. Reaches 500°C in few seconds and cuts quickly even big diameter ropes, braids and cords. It cools immediately thanks to the air-cooling system. Suitable also for cutting of sails, awnings, belts, tapes and any synthetic canvas. Complete with blade, cleaning brush and 3 m power cord. Comes with portable tool box.

Code	Ref	UM	€
3190005	Rope Cutter	PCS	
3190002	Replacement Blade	PCS	
3190006	Belt Cutter Accessory Blade	PCS	



Battery Fusion Cutter

Portable cordless rechargeable battery electric rope cutter. Reaches 400°C in few seconds and cuts quickly even big diameter ropes, braids and cords. Suitable also for cutting of sails, awnings, belts, tapes and any synthetic canvas. Complete with blade, cleaning brush, rechargeable battery and charger. Comes with portable tool box.

Code	Ref	UM	€
3190003	Rope Cutter	PCS	
3190002	Replacement Blade	PCS	
3190006	Belt Cutter Accessory Blade	PCS	
3190004	Replacement Battery	PCS	



Whipping-Twine Polyester Waxed

Waxed Polyester white whipping-twine.



Code	ø mm	Meters	UM	€
3100525	0,5	80	PCS	
3101023	1,0	30	PCS	
3101523	1,5	20	PCS	



Dyneema Whipping Twine

Waxed Dyneema Carbon grey whipping twine.



Code	ø mm	Meters	UM	€
3101025	1,2	30	PCS	



Galvanized Steel Thimbles

Galvanized Steel thimbles that prevent wear on ropes and wires.

Code	Rope ø mm	UM	€
5420010	10	PCS	
5420012	12	PCS	
5420014	14	PCS	
5420016	16	PCS	
5420018	18	PCS	
5420020	20	PCS	
5420022	22	PCS	
5420024	24	PCS	
5420026	26	PCS	
5420028	28	PCS	
5420032	32	PCS	



Stainless Steel Thimbles

AISI 316 Stainless Steel thimbles. Prevent wear on ropes and wires.

Code	Rope ø mm	UM	€
5425001	2	PCS	
5425002	2,5	PCS	
5425003	3	PCS	
5425004	4	PCS	
5425005	5	PCS	
5425006	6	PCS	
5425008	8	PCS	
5425010	10	PCS	
5425012	12	PCS	
5425014	14	PCS	
5425016	16	PCS	
5425018	18	PCS	
5425020	20	PCS	
5425022	22	PCS	
5425024	24/26	PCS	
5425028	28/30	PCS	
5425032	32/34	PCS	
5425036	36/38	PCS	
5425040	40/42	PCS	



Whipping-Twine Colour Polyester Waxed

Waxed Polyester coloured whipping-twine.



Code	ø mm	Meters	Colour	UM	€
3101122	1,5	20	BLUE	PCS	
3101222	1,5	20	BLACK	PCS	



Thermic Rope Ends

Thermic constricting unravelling rope ends. 6 Pieces pack.

Code	Rope ø mm	Pack	UM	€
3191012	6.5<>12.5	6 Pcs	PCK	
3191018	10<>19	6 Pcs	PCK	



Aluminum Oval Sleeves

Anodized Aluminum oval sleeves for splicing.

Code	Rope ø mm	UM	€
5424503	3	PCS	
5424504	4	PCS	
5424505	5	PCS	
5424506	6	PCS	
5424508	8	PCS	
5424510	10	PCS	
5424512	12	PCS	
5424514	14	PCS	



White Plastic Thimbles

White Nylon thimbles that prevent wear on ropes and wires.

Code	Rope ø mm	UM	€
5430004	4	PCS	
5430005	5	PCS	
5430006	6	PCS	
5430008	8	PCS	
5430010	10	PCS	
5430012	12	PCS	
5430014	14	PCS	
5430016	16	PCS	
5430018	18	PCS	
5430020	20	PCS	
5430022	22	PCS	
5430024	24	PCS	



Line-Throwing Ring

Loaded PVC line-thrower ring. Used to throw mooring lines from ship to shore and vice versa.

Code	ø mm	UM	€
3137112	180	PCS	



Loaded Line-Thrower

UV and marine environment leather resistant loaded line-thrower with Stainless Steel eyelet. Used to throw mooring lines from ship to shore and vice versa.

Code	Weight Kg	UM	€
3137114	0,4	PCS	

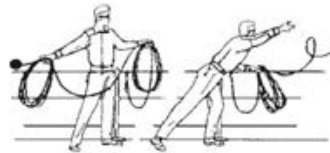

Boatasy Hooklinker Mooring Hook

Boatasy Hooklinker multi-purpose mooring hook for a fast and easy mooring. It allows to pass the mooring rope into the buoy eye or into the dock eyebolt. Thanks to its integrated torch, it can be also used at night.

Code	UM	€
0701730	PCS	



Scrubbis Catching Mooring Hook

Scrubbis Catching multi-purpose mooring hook that can be used as a boat hook to pass the mooring rope into the buoy eye or into the dock eyebolt. It is composed of a hook and a telescopic handle, which has to be purchased separately.

Code	Ref	UM	€
0701710	Mooring Hook	PCS	
5709317	Telescopic Handle (110->210 cm)	PCS	



Kong Mooring Carabiner

Stainless Steel mooring carabiner tip endowed with boathook bayonet connector. It attaches to the hole of the mooring buoy, then when the boathook is retrieved, the carabiner remains attached to the buoy.

Code	UM	€
0701723	PCS	



Mooring Blocks

Stainless Steel mooring blocks.

Code	ø mm	O mm	L mm	Breaking Load Kg	UM	€
5436102	12	14	83	2000	PCS	
5436103	12	14	96	2300	PCS	
5436105	15	20	130	3400	PCS	

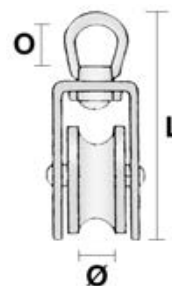

Boatasy Ghook Mooring Line Transfer

Reinforced Plastic Boatasy GHook mooring line transfer for easy, fast and clean mooring. Makes the line recover easy and safe, avoiding dirt and hand damage. Thanks to the 7 cm wide rotating wheel any rope or line can be easily lift up from the water and transferred to the mooring point with one hand only. It can be tied to a rope when the sides are higher.



Code	Dim cm	UM	€
3137120	15 x 23	PCS	



Anchor Mooring Buoy

Anchor mooring buoy with Solas reflective tape and 11 mt of rope. Endowed with lead counterweight that self adjusts the rope length within 4 and 10 mt of depth and allows to mark the exact position of the anchor. It also helps to easily retrieve a fouled anchor.

Code	Dim mm	UM	€
3822210	ø 200 x H507	PCS	

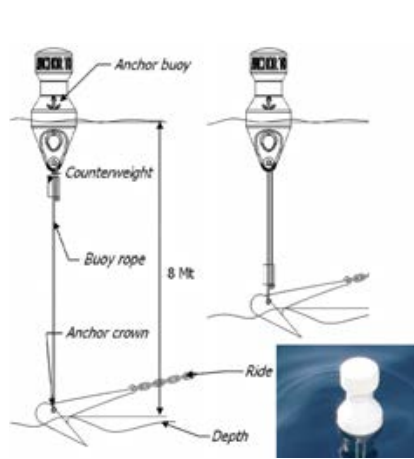

Self-Adjusting Grippy Anchor Buoy

Anchor buoy with self-adjusting buoy rope. Endowed with visual indicator with reflective tape. Allows to mark the exact position of the anchor and it also helps to easily retrieve a fouled anchor. The Light version (3822271) and the Heavy version (3822272) are equipped with dynamic drift limiter able to maintain the anchor buoy on the exact vertical of the anchor even in presence of wind or currents, in addition they are endowed with solar cells for charging the battery. The Heavy version includes also a Stainless Steel wire saver that allows a greater breaking load.

Code	Ref	Line L	Light + Bracket	daN	Accessories	UM	€
3822270	Basic	15 m	No	500		PCS	
3822271	Light	25 m	Yes	500		PCS	
3822272	Heavy	20 m	Yes	1200		PCS	
3822275					10 m Rope	PCS	



Self-Sinking CliK Gold Buoy

Self-sinking buoy with radio controlled lift system for the recovery of the mooring rope. It allows a easy recovery directly on the bow without making it slide manually from one end of the boat to the other. It only requires the installation of the radio control button on the boat. Equipped with high efficiency solar cells for charging the batteries. Complete with magnetic boat hook to facilitate the recovery operations.

Code	Max Operating Depth m	UM	€
3822260	8	PCS	



Flat Hole Buoy

Mark buoys with through hole. For nets, ski ropes, swimming lanes and mooring.

Code	ø mm	Hole ø mm	UM	€
3821045	45	7	PCS	
3821050	50	8	PCS	
3821057	57	8	PCS	
3821075	75	12	PCS	



Small Hole Buoy

Mark buoys with through hole. For marking and mooring.

Code	ø mm	H mm	Hole ø mm	Buoyancy Kg	Colour	UM	€
3820701	170	145	20	1,7	RED	PCS	
3820702	170	145	20	1,7	WHITE	PCS	
3820703	170	145	20	1,7	YELLOW	PCS	



Bicolor Hole Buoy

Two colour mark buoys with through hole. For mooring, ski ropes, swimming lanes.

Code	ø mm	H mm	Hole ø mm	UM	€
3820512	60	100	10	PCS	
3820514	75	130	12	PCS	



Dura Float Round Hole Buoy

Reinforced Plastic signal buoy filled with closed cells foam. Very sturdy, almost indistructible and unsinkable. Hole diameter 35 mm.

Code	ø mm	H mm	Colour	UM	€
3820418	200	200	ORANGE	PCS	
3820419	200	200	YELLOW	PCS	



Anchor Buoy

Heavy duty inflatable anchor buoy with two reinforced eyelets.

Code	ø mm	H mm	Colour	UM	€
3820410	350	460	ORANGE	PCS	
3820411	350	460	YELLOW	PCS	



Flat 1 Hole Buoy

Mark buoys with through hole. For nets, ski ropes, swimming lanes and mooring.

Code	ø mm	Hole ø mm	Colour	UM	€
3821108	80	10	RED	PCS	
3821109	80	10	WHITE	PCS	
3821110	80	10	YELLOW	PCS	



Big Hole Buoy

Mark buoys with through hole. For marking and mooring.

Code	ø mm	H mm	Hole ø mm	Buoyancy Kg	Colour	UM	€
3820704	260	200	30	8,5	RED	PCS	
3820705	260	200	30	8,5	WHITE	PCS	
3820706	260	200	30	8,5	YELLOW	PCS	



Dura Float Olive Hole Buoy

Reinforced Plastic signal buoy filled with closed cells foam. Very sturdy, almost indistructible and unsinkable. Hole diameter 30mm.

Code	ø mm	H mm	Colour	UM	€
3820415	135	175	ORANGE	PCS	
3820416	135	175	YELLOW	PCS	



Jerk Mark Buoy

Reinforced PVC mark buoy. For signalling, marking, mooring etc.

Code	ø mm	H mm	Colour	UM	€
3800297	90	110	ORANGE	PCS	
3800298	90	110	YELLOW	PCS	



SA Anchor and Mark Inflatable Buoy

Inflatable anchor and mark buoy with one eyelet.

Code	Ref	ø mm	H mm	UM	€
3800300	SA00	150	200	PCS	
3802300	SA0	210	280	PCS	
3802301	SA1	260	360	PCS	



Pear Mooring Buoy

Reinforced Plastic pear-shaped mooring buoy.

Code	ø mm	H mm	Buoyancy Kg	Colour	UM	€
3820525	250	390	10	RED	PCS	
3820625	250	390	10	WHITE	PCS	
3820725	250	390	10	YELLOW	PCS	



Double Cone Mooring Buoy

Reinforced Polyethylene double cone mooring buoys.

Code	ø mm	H mm	Buoyancy Kg	Colour	UM	€
3820022	220	490	8	RED	PCS	
3820028	270	600	13	RED	PCS	
3820032	320	800	25	RED	PCS	
3820052	500	1030	55	RED	PCS	
3820122	220	490	8	WHITE	PCS	
3820128	270	600	13	WHITE	PCS	
3820132	320	800	25	WHITE	PCS	
3820152	500	1030	55	WHITE	PCS	
3820222	220	490	8	YELLOW	PCS	
3820228	270	600	13	YELLOW	PCS	
3820232	320	800	25	YELLOW	PCS	



Stainless Steel Rod Mooring Buoy

Polyurethane closed cell foam filled Polyethylene mooring buoy. Stainless Steel through rod and swivel connections.

Code	ø mm	H mm	Buoyancy Kg	UM	€
3822232	320	800	20	PCS	
3822250	500	1030	50	PCS	

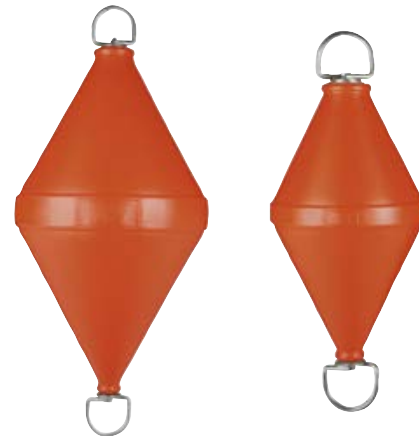

Castro CCFN Mooring Buoy Filled with Polyurethane Foam

Reinforced Polyethylene buoy filled with closed-cell Polyurethane foam.

Rilsan coated high Steel rod.

Great resistance to abrasion and UVA rays.

Exceptional buoyancy.

Code	ø mm	H mm	Buoyancy Kg	UM	€
3822402	400	870	28	PCS	
3822403	460	900	56	PCS	
3822404	550	920	107	PCS	

New



A Polyform Fenders

Heavy Duty pear fenders with reinforced eyelet.

Code	Ref	ø mm	H mm	Buoyancy Kg	Colour	UM	€
3802000	A0	230	280	6,5	WHITE	PCS	
3802001	A1	310	390	16	WHITE	PCS	
3802002	A2	400	510	36	WHITE	PCS	
3802003	A3	490	620	65	WHITE	PCS	
3802004	A4	600	730	116	WHITE	PCS	
3802005	A5	760	940	230	WHITE	PCS	
3802006	A6	940	1190	430	WHITE	PCS	

3802200	A0	230	280	6,5	RED	PCS	
3802201	A1	310	390	16	RED	PCS	
3802202	A2	400	510	36	RED	PCS	
3802203	A3	490	620	65	RED	PCS	
3802204	A4	600	730	116	RED	PCS	
3802205	A5	760	940	230	RED	PCS	
3802206	A6	940	1190	430	RED	PCS	

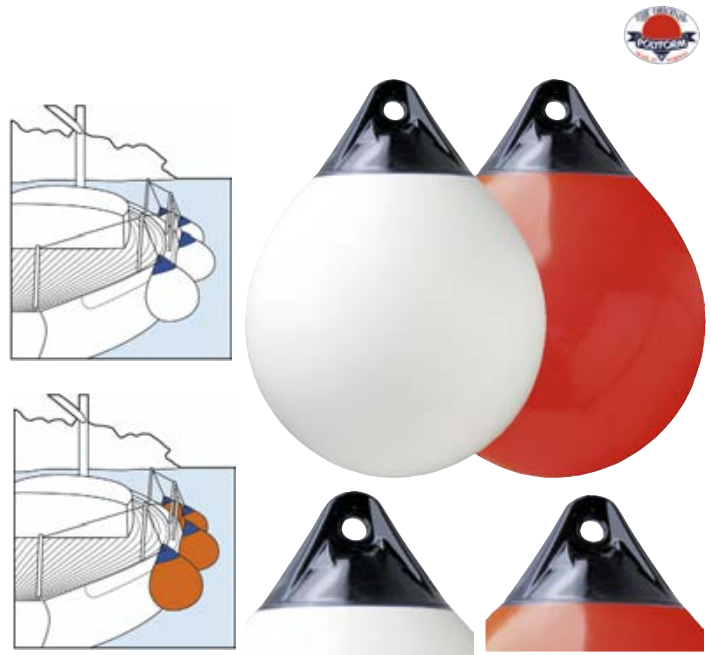

A-HD Castro Fenders

Extremely robust fenders with a reinforced eyelet.

Reinforced ring joint between body and head.

High quality valve for a perfect seal.

Code	Ref	ø mm	H mm	Buoyancy Kg	Colour	UM	€
3802900	A-0HD	200	270	6	WHITE	PCS	
3802901	A-1HD	290	410	15	WHITE	PCS	
3802902	A-2HD	340	490	31	WHITE	PCS	
3802903	A-3HD	460	570	56	WHITE	PCS	
3802904	A-4HD	530	640	90	WHITE	PCS	
3802905	A-5HD	620	800	160	WHITE	PCS	
3802906	A-6HD	850	1000	326	WHITE	PCS	

3802910	A-0HD	200	270	6	RED	PCS	
3802911	A-1HD	290	410	15	RED	PCS	
3802912	A-2HD	340	490	31	RED	PCS	
3802913	A-3HD	460	570	56	RED	PCS	
3802914	A-4HD	530	640	90	RED	PCS	
3802915	A-5HD	620	800	160	RED	PCS	
3802916	A-6HD	850	1000	326	RED	PCS	

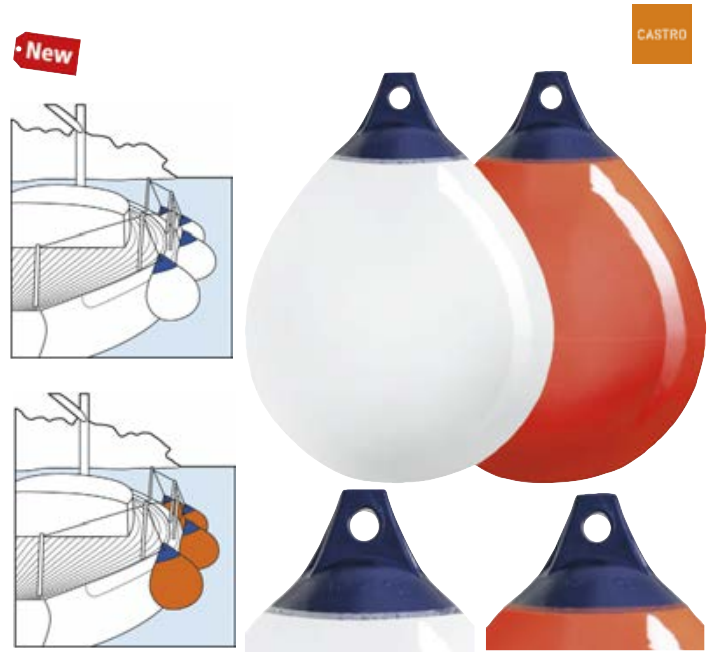

A Majoni Fenders

Heavy Duty pear fenders with reinforced eyelet.

Code	Ref	ø mm	H mm	Buoyancy Kg	Colour	UM	€
3802102	WB-A2	350	480	21	WHITE	PCS	
3802103	WB-A3	450	620	45	WHITE	PCS	
3802104	WB-A4	550	730	83	WHITE	PCS	
3802105	WB-A5	650	880	139	WHITE	PCS	
3802106	WB-A6	850	1050	314	WHITE	PCS	

3802302	RB-A2	350	480	21	RED	PCS	
3802303	RB-A3	450	620	45	RED	PCS	
3802304	RB-A4	550	730	83	RED	PCS	
3802305	RB-A5	650	880	139	RED	PCS	
3802306	RB-A6	850	1050	314	RED	PCS	

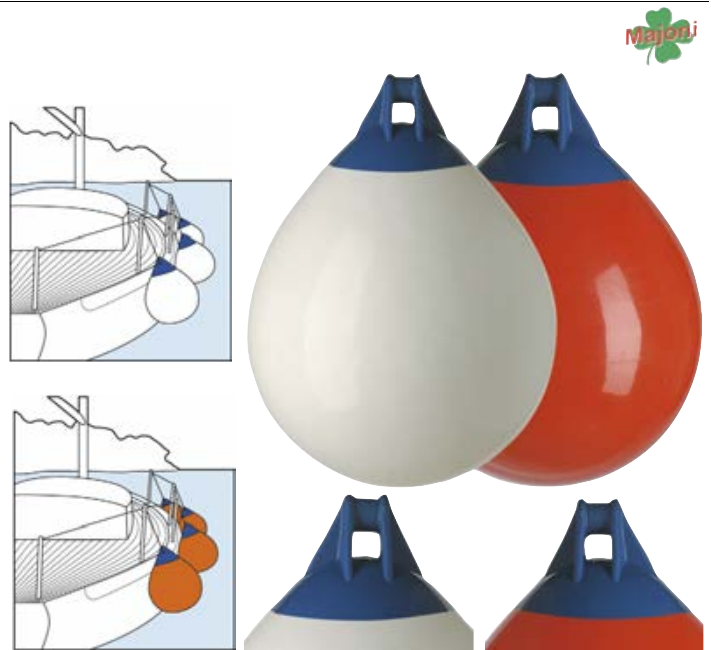

Majoni Blue Head Fenders

Fenders with two eyelets.

Code	Ref	ø mm	L mm	UM	€
3801101	SF1	150	580	PCS	
3801112	SF2A	180	600	PCS	
3801102	SF2	210	620	PCS	
3801103	SF3	240	700	PCS	
3801104	SF4	300	900	PCS	
3801105	SF5	300	820	PCS	
3801106	SF6	350	1100	PCS	

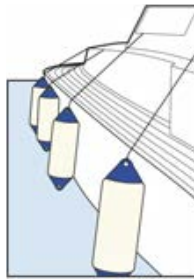

F-Type Castro Fenders

Extremely robust fenders with two reinforced eyelets.

Reinforced ring joint between body and head.

High quality valve for a perfect seal.

Code	Ref	ø mm	L mm	Head	UM	€
3802870	F0	115	420	WHITE	PCS	
3802871	F1	150	610	WHITE	PCS	
3802872	F2/A	180	610	WHITE	PCS	

New

CASTRO

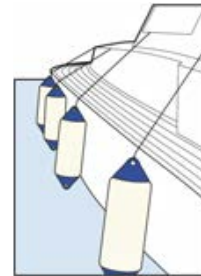
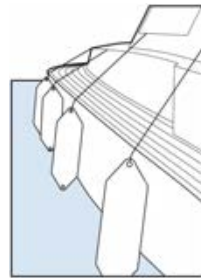

F-Type Polyform Fenders

Fenders with two reinforced eyelets.

Code	Ref	ø mm	L mm	UM	€
3801001	F1	145	610	PCS	
3801022	F02	190	660	PCS	
3801002	F2	220	610	PCS	
3801003	F3	215	745	PCS	
3801004	F4	215	1050	PCS	
3801005	F5	300	770	PCS	
3801006	F6	300	1095	PCS	
3801007	F7	380	1030	PCS	
3801008	F8	380	1475	PCS	

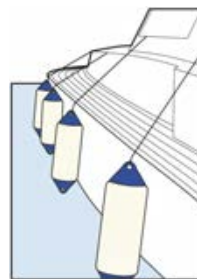

Majoni Mini Fenders

Fenders with two eyelets.

Code	Ref	ø mm	L mm	Colour	UM	€
3800011	SK1	90	300	WHITE/BLUE	PCS	
3800012	KF1	90	300	WHITE	PCS	
3800112	KF1	90	300	BLUE	PCS	
3801100	SF0	120	420	WHITE/BLUE	PCS	
3801200	KF2	120	420	WHITE	PCS	
3801300	KF2	120	420	BLUE	PCS	



G-Type Polyform Fenders

Fenders with two eyelets.

Code	Ref	ø mm	L mm	UM	€
3800202	G2	117	407	PCS	
3800203	G3	145	515	PCS	
3800204	G4	170	585	PCS	
3800205	G5	215	705	PCS	

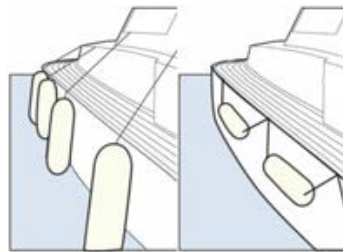

G-Type Castro Fenders

Resistant and lightweight G-Type fenders with reinforced eyelets. High quality valve for a perfect seal.

New

Code	Ref	ø mm	L mm	UM	€
3802831	G1	90	330	PCS	
3802832	G2	115	410	PCS	
3802833	G3	140	510	PCS	
3802834	G4	165	590	PCS	
3802835	G5	220	700	PCS	

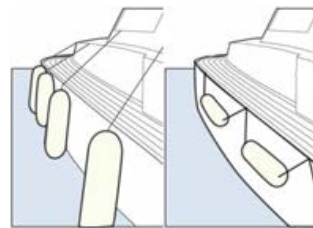

CASTRO

Majoni Center Hole Fenders

Majoni center hole fenders.

Code	ø mm	L mm	UM	€
3801800	100	300	PCS	
3801801	150	430	PCS	
3801802	200	550	PCS	
3801803	250	680	PCS	
3801804	300	800	PCS	

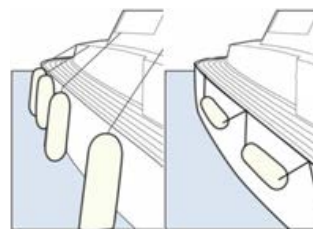

HAG Castro Fenders

Extremely robust through hole fenders. High quality valve for a perfect seal.

New

Code	Ref	ø mm	L mm	UM	€
3802861	HAG1	150	400	PCS	
3802862	HAG2	200	520	PCS	
3802863	HAG3	250	700	PCS	
3802864	HAG4	300	900	PCS	

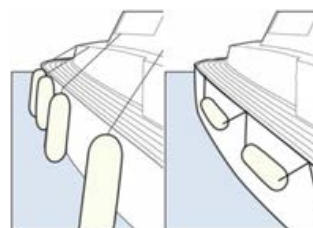

CASTRO

Majoni White/Blue Classic Fenders

Fenders with two reinforced eyelets.

Code	Ref	ø mm	L mm	Colour	UM	€
3801401	CW-F0	120	480	WHITE	PCS	
3801402	CW-F1	140	530	WHITE	PCS	
3801403	CW-F2A	170	580	WHITE	PCS	
3801404	CW-F2	210	640	WHITE	PCS	
3801405	CW-F3	230	720	WHITE	PCS	
3801406	CW-F4	270	810	WHITE	PCS	

3801041	CN-F0	120	480	BLUE	PCS	
3801042	CN-F1	140	530	BLUE	PCS	
3801043	CN-F2A	170	580	BLUE	PCS	
3801044	CN-F2	210	640	BLUE	PCS	
3801045	CN-F3	230	720	BLUE	PCS	
3801046	CN-F4	270	810	BLUE	PCS	



Majoni Classic Grey/Black Fenders

Fenders with two reinforced eyelets.

Code	Ref	ø mm	L mm	Colour	UM	€
3801311	CG-F0	120	480	GREY	PCS	
3801312	CG-F1	140	530	GREY	PCS	
3801313	CG-F2A	170	580	GREY	PCS	
3801314	CG-F2	210	640	GREY	PCS	
3801315	CG-F3	230	720	GREY	PCS	
3801316	CG-F4	270	810	GREY	PCS	

3801301	CB-F0	120	480	BLACK	PCS	
3801302	CB-F1	140	530	BLACK	PCS	
3801303	CB-F2A	170	580	BLACK	PCS	
3801304	CB-F2	210	640	BLACK	PCS	
3801305	CB-F3	230	720	BLACK	PCS	
3801306	CB-F4	270	810	BLACK	PCS	



NFD Castro Fenders

Very robust fenders with a modern and elegant design.

Large fender capacity thanks to their wider surface.

Recessed reinforced eyelet and high quality valve for a perfect seal.

Code	Ref	ø mm	L mm	Colour	UM	€
3802801	NFD1	180	510	WHITE	PCS	
3802802	NFD2	220	600	WHITE	PCS	
3802803	NFD3	260	710	WHITE	PCS	

3802811	NFD1	180	510	BLUE	PCS	
3802812	NFD2	220	600	BLUE	PCS	
3802813	NFD3	260	710	BLUE	PCS	

3802821	NFD1	180	510	BLACK	PCS	
3802822	NFD2	220	600	BLACK	PCS	
3802823	NFD3	260	710	BLACK	PCS	



Blue Modular Flat Fenders

High resistance E.V.A. closed-cell soft foam flat modular fenders. Easy storage thanks to the flat shape, they are used when there is not enough space between two boats. Easy to fasten together to create a protection barrier. With 4 holes for line and 2 holes for belt. 2.40 m line included.



Code	H mm	L mm	>mm<	UM	€
3803062	490	180	50	PCS	
3803063	650	300	80	PCS	
3803064	950	310	80	PCS	

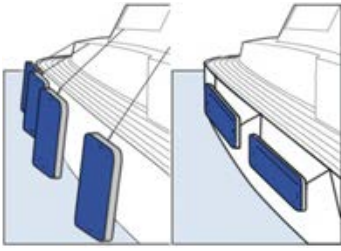

ANCHORING/MOORING/FENDERS BUOYS

Grey Modular Flat Fenders

High resistance E.V.A. closed-cell soft foam flat modular fenders. Easy storage thanks to the flat shape, they are used when there is not enough space between two boats. Easy to fasten together to create a protection barrier. With 4 holes for line and 2 holes for belt. 2.10 m line included.



Code	H mm	L mm	>mm<	UM	€
3803066	490	180	50	PCS	
3803067	650	300	80	PCS	
3803068	950	310	80	PCS	

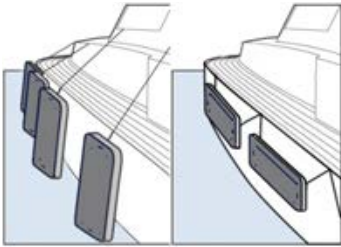

Multi Fender Dock Guard

Folding bumper with elastic structure which allows to round and protect any irregular or plain surface. Can be applied to bulwarks, poles, railings, angles and as bowbuoy.



Code	Dimensions cm	UM	€
3837504	60 x 30 x 8	PCS	



Jobe Infinity Defender Stern Fender

Jobe Infinity Defender stern fender is the ideal solution to avoid damage during docking. Equipped with four D-rings for easy use.



Code	Dimensions (L x ø) cm	UM	€
3803082	200 x 48	PCS	
3803084	400 x 48	PCS	

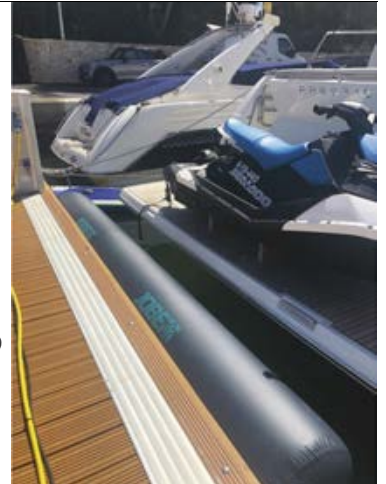

Mega Fender

Mega Fender inflatable fenders designed to protect large boats and mega yachts. Great lightness and great ease of handling, while their particular valve and their high flexibility allow to be easy deflated and to be rapidly stored (can fit in tight spaces). Very sturdy, made of Kevlar thread with strenghtened strips. Traction Stainless Steel strap rings.

Code	Sizes (L x ø) cm	Sizes (L x ø) "	UM	€
3803500	56 x 23	22 x 9	PCS	
3803502	76 x 23	30 x 9	PCS	
3803504	91 x 36	36 x 14	PCS	
3803510	107 x 46	42 x 18	PCS	
3803512	114 x 46	45 x 18	PCS	
3803514	147 x 46	58 x 18	PCS	
3803520	74 x 61	29 x 21	PCS	
3803522	107 x 61	42 x 24	PCS	
3803524	147 x 61	58 x 24	PCS	
3803526	165 x 66	65 x 26	PCS	
3803528	168 x 61	66 x 24	PCS	
3803530	244 x 61	96 x 24	PCS	
3803532	191 x 97	75 x 38	PCS	
3803540	125 x 90	49 x 35	PCS	
3803545	150 x 125	59 x 49	PCS	
3803547	210 x 90	83 x 35	PCS	



Fendress

Mega Fender Covers

Strong fleece Fendress fender covers for Mega Fender fenders. Protects Mega Fenders eliminating wear, scuff marks and squeaks. Soft and tough, they don't stain the sides and they last longer.

Code	Colour	For Fender (L x ø) cm	UM	€
3813500	BLUE NAVY	56 x 23	PCS	
3813502	BLUE NAVY	76 x 23	PCS	
3813504	BLUE NAVY	91 x 36	PCS	
3813510	BLUE NAVY	107 x 46	PCS	
3813512	BLUE NAVY	114 x 46	PCS	
3813514	BLUE NAVY	147 x 46	PCS	
3813520	BLUE NAVY	74 x 61	PCS	
3813522	BLUE NAVY	107 x 61	PCS	
3813524	BLUE NAVY	147 x 61	PCS	
3813526	BLUE NAVY	165 x 66	PCS	
3813528	BLUE NAVY	168 x 61	PCS	
3813530	BLUE NAVY	244 x 61	PCS	
3813532	BLUE NAVY	191 x 97	PCS	
3813540	BLUE NAVY	125 x 90	PCS	
3813545	BLUE NAVY	150 x 125	PCS	
3813547	BLUE NAVY	210 x 90	PCS	
3813500BK	BLACK	56 x 23	PCS	
3813502BK	BLACK	76 x 23	PCS	
3813504BK	BLACK	91 x 36	PCS	
3813510BK	BLACK	107 x 46	PCS	
3813512BK	BLACK	114 x 46	PCS	
3813514BK	BLACK	147 x 46	PCS	
3813520BK	BLACK	74 x 61	PCS	
3813522BK	BLACK	107 x 61	PCS	
3813524BK	BLACK	147 x 61	PCS	
3813526BK	BLACK	165 x 66	PCS	
3813528BK	BLACK	168 x 61	PCS	
3813530BK	BLACK	244 x 61	PCS	
3813532BK	BLACK	191 x 97	PCS	
3813540BK	BLACK	125 x 90	PCS	
3813545BK	BLACK	150 x 125	PCS	
3813547BK	BLACK	210 x 90	PCS	
3813500DG	ANTHRACITE GREY	56 x 23	PCS	
3813502DG	ANTHRACITE GREY	76 x 23	PCS	
3813504DG	ANTHRACITE GREY	91 x 36	PCS	
3813510DG	ANTHRACITE GREY	107 x 46	PCS	
3813512DG	ANTHRACITE GREY	114 x 46	PCS	
3813514DG	ANTHRACITE GREY	147 x 46	PCS	
3813520DG	ANTHRACITE GREY	74 x 61	PCS	
3813522DG	ANTHRACITE GREY	107 x 61	PCS	
3813524DG	ANTHRACITE GREY	147 x 61	PCS	
3813526DG	ANTHRACITE GREY	165 x 66	PCS	
3813528DG	ANTHRACITE GREY	168 x 61	PCS	
3813530DG	ANTHRACITE GREY	244 x 61	PCS	
3813532DG	ANTHRACITE GREY	191 x 97	PCS	
3813540DG	ANTHRACITE GREY	125 x 90	PCS	
3813545DG	ANTHRACITE GREY	150 x 125	PCS	
3813547DG	ANTHRACITE GREY	210 x 90	PCS	



F-Type Fendress Fendercovers

Plush fleece handmade Fendress fender covers. Premium protection for your fenders, while eliminating fender squeak and scuff marks. Soft and tough, these fender covers protect efficiently your gel-coat paint and make your fenders last longer. • "Fendress Covers" are 100% Acrylic handmade premium quality resistant, non abrasive loop knit. Soft, plush fleece fender covers offer the ultimate protection for your topsides. • "Fendress Covers" are UV and sea water resistant, protecting efficiently your gel-coat paint from scuff marks and abrasions. The tensile and rugged fleece fabric contains all the best characteristics, including tear & abrasion resistance, quick drying ability and easy removal for cleaning. • "Fendress Covers" make your fenders last longer and eliminate irritating fender squeak. UV resistant colors do not mark your topsides. Machine washable. • "Fendress Covers" high resistance top and elasticized bottom hem permit a custom fit for all type of fenders. Covers are available in 9 colours.

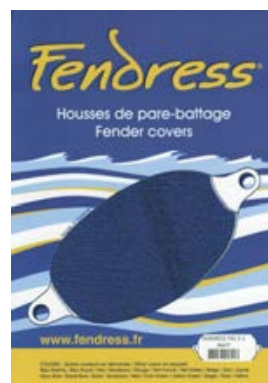

Fendress

Code	Type	Colour	Fender ø	Fender L	UM	€
3811001	F1	BLUE NAVY	14<>16 cm	58<>62 cm	PCS	
3811012	F02	BLUE NAVY	19<>21 cm	64<>68 cm	PCS	
3811002	F2	BLUE NAVY	21<>24 cm	60<>64 cm	PCS	
3811003	F3	BLUE NAVY	21<>24 cm	72<>78 cm	PCS	
3811004	F4	BLUE NAVY	21<>23 cm	100<>108 cm	PCS	
3811014	SF4	BLUE NAVY	29<>32 cm	88<>92 cm	PCS	
3811005	F5	BLUE NAVY	29<>32 cm	74<>78 cm	PCS	
3811006	F6	BLUE NAVY	29<>32 cm	106<>110 cm	PCS	
3811007	F7	BLUE NAVY	36<>40 cm	100<>108 cm	PCS	
3811018	F8	BLUE NAVY	36<>40 cm	140<>150 cm	PCS	
3811020	F10	BLUE NAVY	47<>52 cm	120<>130 cm	PCS	
3811021	F11	BLUE NAVY	58<>62 cm	140<>150 cm	PCS	
3811023	F13	BLUE NAVY	78<>82 cm	190<>200 cm	PCS	

3811001BR	F1	BLUE ROYAL	14<>16 cm	58<>62 cm	PCS	
3811012BR	F02	BLUE ROYAL	19<>21 cm	64<>68 cm	PCS	
3811002BR	F2	BLUE ROYAL	21<>24 cm	60<>64 cm	PCS	
3811003BR	F3	BLUE ROYAL	21<>24 cm	72<>78 cm	PCS	
3811004BR	F4	BLUE ROYAL	21<>23 cm	100<>108 cm	PCS	
3811014BR	SF4	BLUE ROYAL	29<>32 cm	88<>92 cm	PCS	
3811005BR	F5	BLUE ROYAL	29<>32 cm	74<>78 cm	PCS	
3811006BR	F6	BLUE ROYAL	29<>32 cm	106<>110 cm	PCS	
3811007BR	F7	BLUE ROYAL	36<>40 cm	100<>108 cm	PCS	
3811018BR	F8	BLUE ROYAL	36<>40 cm	140<>150 cm	PCS	
3811020BR	F10	BLUE ROYAL	47<>52 cm	120<>130 cm	PCS	
3811021BR	F11	BLUE ROYAL	58<>62 cm	140<>150 cm	PCS	
3811023BR	F13	BLUE ROYAL	78<>82 cm	190<>200 cm	PCS	

3811001JA	F1	JADE	14<>16 cm	58<>62 cm	PCS	
3811012JA	F02	JADE	19<>21 cm	64<>68 cm	PCS	
3811002JA	F2	JADE	21<>24 cm	60<>64 cm	PCS	
3811003JA	F3	JADE	21<>24 cm	72<>78 cm	PCS	
3811004JA	F4	JADE	21<>23 cm	100<>108 cm	PCS	
3811014JA	SF4	JADE	29<>32 cm	88<>92 cm	PCS	
3811005JA	F5	JADE	29<>32 cm	74<>78 cm	PCS	
3811006JA	F6	JADE	29<>32 cm	106<>110 cm	PCS	
3811007JA	F7	JADE	36<>40 cm	100<>108 cm	PCS	
3811018JA	F8	JADE	36<>40 cm	140<>150 cm	PCS	
3811020JA	F10	JADE	47<>52 cm	120<>130 cm	PCS	
3811021JA	F11	JADE	58<>62 cm	140<>150 cm	PCS	
3811023JA	F13	JADE	78<>82 cm	190<>200 cm	PCS	

3811001WN	F1	RED WINE	14<>16 cm	58<>62 cm	PCS	
3811012WN	F02	RED WINE	19<>21 cm	64<>68 cm	PCS	
3811002WN	F2	RED WINE	21<>24 cm	60<>64 cm	PCS	
3811003WN	F3	RED WINE	21<>24 cm	72<>78 cm	PCS	
3811004WN	F4	RED WINE	21<>23 cm	100<>108 cm	PCS	
3811014WN	SF4	RED WINE	29<>32 cm	88<>92 cm	PCS	
3811005WN	F5	RED WINE	29<>32 cm	74<>78 cm	PCS	
3811006WN	F6	RED WINE	29<>32 cm	106<>110 cm	PCS	
3811007WN	F7	RED WINE	36<>40 cm	100<>108 cm	PCS	
3811018WN	F8	RED WINE	36<>40 cm	140<>150 cm	PCS	
3811020WN	F10	RED WINE	47<>52 cm	120<>130 cm	PCS	
3811021WN	F11	RED WINE	58<>62 cm	140<>150 cm	PCS	
3811023WN	F13	RED WINE	78<>82 cm	190<>200 cm	PCS	



Code	Type	Colour	Fender ø	Fender L	UM	€
3811001SA	F1	SAND	14<>16 cm	58<>62 cm	PCS	
3811012SA	F02	SAND	19<>21 cm	64<>68 cm	PCS	
3811002SA	F2	SAND	21<>24 cm	60<>64 cm	PCS	
3811003SA	F3	SAND	21<>24 cm	72<>78 cm	PCS	
3811004SA	F4	SAND	21<>23 cm	100<>108 cm	PCS	
3811014SA	SF4	SAND	29<>32 cm	88<>92 cm	PCS	
3811005SA	F5	SAND	29<>32 cm	74<>78 cm	PCS	
3811006SA	F6	SAND	29<>32 cm	106<>110 cm	PCS	
3811007SA	F7	SAND	36<>40 cm	100<>108 cm	PCS	
3811018SA	F8	SAND	36<>40 cm	140<>150 cm	PCS	
3811020SA	F10	SAND	47<>52 cm	120<>130 cm	PCS	
3811021SA	F11	SAND	58<>62 cm	140<>150 cm	PCS	
3811023SA	F13	SAND	78<>82 cm	190<>200 cm	PCS	

3811001LI	F1	LINEN	14<>16 cm	58<>62 cm	PCS	
3811012LI	F02	LINEN	19<>21 cm	64<>68 cm	PCS	
3811002LI	F2	LINEN	21<>24 cm	60<>64 cm	PCS	
3811003LI	F3	LINEN	21<>24 cm	72<>78 cm	PCS	
3811004LI	F4	LINEN	21<>23 cm	100<>108 cm	PCS	
3811014LI	SF4	LINEN	29<>32 cm	88<>92 cm	PCS	
3811005LI	F5	LINEN	29<>32 cm	74<>78 cm	PCS	
3811006LI	F6	LINEN	29<>32 cm	106<>110 cm	PCS	
3811007LI	F7	LINEN	36<>40 cm	100<>108 cm	PCS	
3811018LI	F8	LINEN	36<>40 cm	140<>150 cm	PCS	
3811020LI	F10	LINEN	47<>52 cm	120<>130 cm	PCS	
3811021LI	F11	LINEN	58<>62 cm	140<>150 cm	PCS	
3811023LI	F13	LINEN	78<>82 cm	190<>200 cm	PCS	

3811001SG	F1	SOFT GREY	14<>16 cm	58<>62 cm	PCS	
3811012SG	F02	SOFT GREY	19<>21 cm	64<>68 cm	PCS	
3811002SG	F2	SOFT GREY	21<>24 cm	60<>64 cm	PCS	
3811003SG	F3	SOFT GREY	21<>24 cm	72<>78 cm	PCS	
3811004SG	F4	SOFT GREY	21<>23 cm	100<>108 cm	PCS	
3811014SG	SF4	SOFT GREY	29<>32 cm	88<>92 cm	PCS	
3811005SG	F5	SOFT GREY	29<>32 cm	74<>78 cm	PCS	
3811006SG	F6	SOFT GREY	29<>32 cm	106<>110 cm	PCS	
3811007SG	F7	SOFT GREY	36<>40 cm	100<>108 cm	PCS	
3811018SG	F8	SOFT GREY	36<>40 cm	140<>150 cm	PCS	
3811020SG	F10	SOFT GREY	47<>52 cm	120<>130 cm	PCS	
3811021SG	F11	SOFT GREY	58<>62 cm	140<>150 cm	PCS	
3811023SG	F13	SOFT GREY	78<>82 cm	190<>200 cm	PCS	

3811001DG	F1	DARK GREY	14<>16 cm	58<>62 cm	PCS	
3811012DG	F02	DARK GREY	19<>21 cm	64<>68 cm	PCS	
3811002DG	F2	DARK GREY	21<>24 cm	60<>64 cm	PCS	
3811003DG	F3	DARK GREY	21<>24 cm	72<>78 cm	PCS	
3811004DG	F4	DARK GREY	21<>23 cm	100<>108 cm	PCS	
3811014DG	SF4	DARK GREY	29<>32 cm	88<>92 cm	PCS	
3811005DG	F5	DARK GREY	29<>32 cm	74<>78 cm	PCS	
3811006DG	F6	DARK GREY	29<>32 cm	106<>110 cm	PCS	
3811007DG	F7	DARK GREY	36<>40 cm	100<>108 cm	PCS	
3811018DG	F8	DARK GREY	36<>40 cm	140<>150 cm	PCS	
3811020DG	F10	DARK GREY	47<>52 cm	120<>130 cm	PCS	
3811021DG	F11	DARK GREY	58<>62 cm	140<>150 cm	PCS	
3811023DG	F13	DARK GREY	78<>82 cm	190<>200 cm	PCS	

3811001BK	F1	BLACK	14<>16 cm	58<>62 cm	PCS	
3811012BK	F02	BLACK	19<>21 cm	64<>68 cm	PCS	
3811002BK	F2	BLACK	21<>24 cm	60<>64 cm	PCS	
3811003BK	F3	BLACK	21<>24 cm	72<>78 cm	PCS	
3811004BK	F4	BLACK	21<>23 cm	100<>108 cm	PCS	
3811014BK	SF4	BLACK	29<>32 cm	88<>92 cm	PCS	
3811005BK	F5	BLACK	29<>32 cm	74<>78 cm	PCS	
3811006BK	F6	BLACK	29<>32 cm	106<>110 cm	PCS	
3811007BK	F7	BLACK	36<>40 cm	100<>108 cm	PCS	
3811018BK	F8	BLACK	36<>40 cm	140<>150 cm	PCS	
3811020BK	F10	BLACK	47<>52 cm	120<>130 cm	PCS	
3811021BK	F11	BLACK	58<>62 cm	140<>150 cm	PCS	
3811023BK	F13	BLACK	78<>82 cm	190<>200 cm	PCS	



A-Type Fendress Fendercovers

Plush fleece handmade Fendress fender covers. Premium protection for your fenders, while eliminating fender squeak and scuff marks. Soft and tough, these fender covers protect efficiently your gel-coat paint and make your fenders last longer. • "Fendress Covers" are 100% Acrylic handmade premium quality resistant, non abrasive loop knit. Soft, plush fleece fender covers offer the ultimate protection for your topsides. • "Fendress Covers" are UV and sea water resistant, protecting efficiently your gel-coat paint from scuff marks and abrasions. The tensile and rugged fleece fabric contains all the best characteristics, including tear & abrasion resistance, quick drying ability and easy removal for cleaning. • "Fendress Covers" make your fenders last longer and eliminate irritating fender squeak. UV resistant colors do not mark your topsides. Machine washable. • "Fendress Covers" high resistance top and elasticized bottom hem permit a custom fit for all type of fenders. Covers are available in 9 colours.

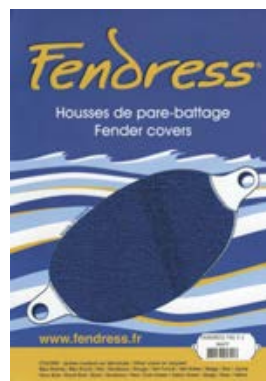

Fendress

Code	Type	Colour	Buoy ø	Buoy Length	UM	€
3811101	A1	BLUE NAVY	28<->31 cm	36<->39 cm	PCS	
3811102	A2	BLUE NAVY	38<->41 cm	48<->51 cm	PCS	
3811103	A3	BLUE NAVY	46<->50 cm	58<->62 cm	PCS	
3811104	A4	BLUE NAVY	54<->60 cm	68<->73 cm	PCS	
3811105	A5	BLUE NAVY	68<->76 cm	90<->95 cm	PCS	
3811106	A6	BLUE NAVY	84<->90 cm	115<->120 cm	PCS	
3811107	A7	BLUE NAVY	100<->110 cm	135<->145 cm	PCS	

3811101BR	A1	BLUE ROYAL	28<->31 cm	36<->39 cm	PCS	
3811102BR	A2	BLUE ROYAL	38<->41 cm	48<->51 cm	PCS	
3811103BR	A3	BLUE ROYAL	46<->50 cm	58<->62 cm	PCS	
3811104BR	A4	BLUE ROYAL	54<->60 cm	68<->73 cm	PCS	
3811105BR	A5	BLUE ROYAL	68<->76 cm	90<->95 cm	PCS	
3811106BR	A6	BLUE ROYAL	84<->90 cm	115<->120 cm	PCS	
3811107BR	A7	BLUE ROYAL	100<->110 cm	135<->145 cm	PCS	

3811101JA	A1	JADE	28<->31 cm	36<->39 cm	PCS	
3811102JA	A2	JADE	38<->41 cm	48<->51 cm	PCS	
3811103JA	A3	JADE	46<->50 cm	58<->62 cm	PCS	
3811104JA	A4	JADE	54<->60 cm	68<->73 cm	PCS	
3811105JA	A5	JADE	68<->76 cm	90<->95 cm	PCS	
3811106JA	A6	JADE	84<->90 cm	115<->120 cm	PCS	
3811107JA	A7	JADE	100<->110 cm	135<->145 cm	PCS	

3811101WN	A1	RED WINE	28<->31 cm	36<->39 cm	PCS	
3811102WN	A2	RED WINE	38<->41 cm	48<->51 cm	PCS	
3811103WN	A3	RED WINE	46<->50 cm	58<->62 cm	PCS	
3811104WN	A4	RED WINE	54<->60 cm	68<->73 cm	PCS	
3811105WN	A5	RED WINE	68<->76 cm	90<->95 cm	PCS	
3811106WN	A6	RED WINE	84<->90 cm	115<->120 cm	PCS	
3811107WN	A7	RED WINE	100<->110 cm	135<->145 cm	PCS	



Code	Type	Colour	Buoy ø	Buoy Length	UM	€
3811101SA	A1	SAND	28<->31 cm	36<->39 cm	PCS	
3811102SA	A2	SAND	38<->41 cm	48<->51 cm	PCS	
3811103SA	A3	SAND	46<->50 cm	58<->62 cm	PCS	
3811104SA	A4	SAND	54<->60 cm	68<->73 cm	PCS	
3811105SA	A5	SAND	68<->76 cm	90<->95 cm	PCS	
3811106SA	A6	SAND	84<->90 cm	115<->120 cm	PCS	
3811107SA	A7	SAND	100<->110 cm	135<->145 cm	PCS	

3811101LI	A1	LINEN	28<->31 cm	36<->39 cm	PCS	
3811102LI	A2	LINEN	38<->41 cm	48<->51 cm	PCS	
3811103LI	A3	LINEN	46<->50 cm	58<->62 cm	PCS	
3811104LI	A4	LINEN	54<->60 cm	68<->73 cm	PCS	
3811105LI	A5	LINEN	68<->76 cm	90<->95 cm	PCS	
3811106LI	A6	LINEN	84<->90 cm	115<->120 cm	PCS	
3811107LI	A7	LINEN	100<->110 cm	135<->145 cm	PCS	

3811101SG	A1	SOFT GREY	28<->31 cm	36<->39 cm	PCS	
3811102SG	A2	SOFT GREY	38<->41 cm	48<->51 cm	PCS	
3811103SG	A3	SOFT GREY	46<->50 cm	58<->62 cm	PCS	
3811104SG	A4	SOFT GREY	54<->60 cm	68<->73 cm	PCS	
3811105SG	A5	SOFT GREY	68<->76 cm	90<->95 cm	PCS	
3811106SG	A6	SOFT GREY	84<->90 cm	115<->120 cm	PCS	
3811107SG	A7	SOFT GREY	100<->110 cm	135<->145 cm	PCS	

3811101DG	A1	DARK GREY	28<->31 cm	36<->39 cm	PCS	
3811102DG	A2	DARK GREY	38<->41 cm	48<->51 cm	PCS	
3811103DG	A3	DARK GREY	46<->50 cm	58<->62 cm	PCS	
3811104DG	A4	DARK GREY	54<->60 cm	68<->73 cm	PCS	
3811105DG	A5	DARK GREY	68<->76 cm	90<->95 cm	PCS	
3811106DG	A6	DARK GREY	84<->90 cm	115<->120 cm	PCS	
3811107DG	A7	DARK GREY	100<->110 cm	135<->145 cm	PCS	

3811101BK	A1	BLACK	28<->31 cm	36<->39 cm	PCS	
3811102BK	A2	BLACK	38<->41 cm	48<->51 cm	PCS	
3811103BK	A3	BLACK	46<->50 cm	58<->62 cm	PCS	
3811104BK	A4	BLACK	54<->60 cm	68<->73 cm	PCS	
3811105BK	A5	BLACK	68<->76 cm	90<->95 cm	PCS	
3811106BK	A6	BLACK	84<->90 cm	115<->120 cm	PCS	
3811107BK	A7	BLACK	100<->110 cm	135<->145 cm	PCS	



Navishell F-Type Fender Covers

Knitted Acrylic marine fabric fender cover. UV rays, sea water and weather conditions resistant. Tested according to law TS4460 / BS EN ISO105 / B04 in grade 7. • tear and abrasion resistant, it covers and protects fender from shock and usury • protects the boat sides avoiding squeak and dirt • easy to install, thanks to the special drawstring closure it fits perfectly all fenders • does not drench and quick dries • long lasting, hand or machine washable at 30°C



Code	Type	Colour	Fender ø	Fender L	UM	€
3813001	F1	BLUE NAVY	14<>16 cm	58<>62 cm	PCS	
3813002	F2/F02	BLUE NAVY	21<>24 cm	60<>64 cm	PCS	
3813003	F3	BLUE NAVY	21<>24 cm	72<>78 cm	PCS	
3813004	F4	BLUE NAVY	21<>23 cm	100<>108 cm	PCS	
3813005	F5	BLUE NAVY	29<>32 cm	74<>78 cm	PCS	
3813006	F6	BLUE NAVY	29<>32 cm	106<>110 cm	PCS	
3813007	F7	BLUE NAVY	36<>40 cm	100<>108 cm	PCS	
3813008	F8	BLUE NAVY	36<>40 cm	140<>150 cm	PCS	
3813010	F10	BLUE NAVY	47<>52 cm	120<>130 cm	PCS	
3813011	F11	BLUE NAVY	58<>62 cm	140<>150 cm	PCS	
3813013	F13	BLUE NAVY	78<>82 cm	190<>200 cm	PCS	

3813001SA	F1	SAND	14<>16 cm	58<>62 cm	PCS	
3813002SA	F2/F02	SAND	21<>24 cm	60<>64 cm	PCS	
3813003SA	F3	SAND	21<>24 cm	72<>78 cm	PCS	
3813004SA	F4	SAND	21<>23 cm	100<>108 cm	PCS	
3813005SA	F5	SAND	29<>32 cm	74<>78 cm	PCS	
3813006SA	F6	SAND	29<>32 cm	106<>110 cm	PCS	
3813007SA	F7	SAND	36<>40 cm	100<>108 cm	PCS	
3813008SA	F8	SAND	36<>40 cm	140<>150 cm	PCS	
3813010SA	F10	SAND	47<>52 cm	120<>130 cm	PCS	
3813011SA	F11	SAND	58<>62 cm	140<>150 cm	PCS	
3813013SA	F13	SAND	78<>82 cm	190<>200 cm	PCS	

3813001GY	F1	GREY	14<>16 cm	58<>62 cm	PCS	
3813002GY	F2/F02	GREY	21<>24 cm	60<>64 cm	PCS	
3813003GY	F3	GREY	21<>24 cm	72<>78 cm	PCS	
3813004GY	F4	GREY	21<>23 cm	100<>108 cm	PCS	
3813005GY	F5	GREY	29<>32 cm	74<>78 cm	PCS	
3813006GY	F6	GREY	29<>32 cm	106<>110 cm	PCS	
3813007GY	F7	GREY	36<>40 cm	100<>108 cm	PCS	
3813008GY	F8	GREY	36<>40 cm	140<>150 cm	PCS	
3813010GY	F10	GREY	47<>52 cm	120<>130 cm	PCS	
3813011GY	F11	GREY	58<>62 cm	140<>150 cm	PCS	
3813013GY	F13	GREY	78<>82 cm	190<>200 cm	PCS	

3813001BK	F1	BLACK	14<>16 cm	58<>62 cm	PCS	
3813002BK	F2/F02	BLACK	21<>24 cm	60<>64 cm	PCS	
3813003BK	F3	BLACK	21<>24 cm	72<>78 cm	PCS	
3813004BK	F4	BLACK	21<>23 cm	100<>108 cm	PCS	
3813005BK	F5	BLACK	29<>32 cm	74<>78 cm	PCS	
3813006BK	F6	BLACK	29<>32 cm	106<>110 cm	PCS	
3813007BK	F7	BLACK	36<>40 cm	100<>108 cm	PCS	
3813008BK	F8	BLACK	36<>40 cm	140<>150 cm	PCS	
3813010BK	F10	BLACK	47<>52 cm	120<>130 cm	PCS	
3813011BK	F11	BLACK	58<>62 cm	140<>150 cm	PCS	
3813013BK	F13	BLACK	78<>82 cm	190<>200 cm	PCS	

3813001BO	F1	RED WINE	14<>16 cm	58<>62 cm	PCS	
3813002BO	F2/F02	RED WINE	21<>24 cm	60<>64 cm	PCS	
3813003BO	F3	RED WINE	21<>24 cm	72<>78 cm	PCS	
3813004BO	F4	RED WINE	21<>23 cm	100<>108 cm	PCS	
3813005BO	F5	RED WINE	29<>32 cm	74<>78 cm	PCS	
3813006BO	F6	RED WINE	29<>32 cm	106<>110 cm	PCS	
3813007BO	F7	RED WINE	36<>40 cm	100<>108 cm	PCS	
3813008BO	F8	RED WINE	36<>40 cm	140<>150 cm	PCS	
3813010BO	F10	RED WINE	47<>52 cm	120<>130 cm	PCS	
3813011BO	F11	RED WINE	58<>62 cm	140<>150 cm	PCS	
3813013BO	F13	RED WINE	78<>82 cm	190<>200 cm	PCS	



Navishell A-Type Fender Covers

Knitted Acrylic marine fabric fender cover. UV rays, sea water and weather conditions resistant. Tested according to law TS4460 / BS EN ISO105 / B04 in grade 7. • tear and abrasion resistant, it covers and protects fender from shock and usury • protects the boat sides avoiding squeak and dirt • easy to install, thanks to the special drawstring closure it fits perfectly all fenders • does not drench and quick dries • long lasting, hand or machine washable at 30°C



Code	Type	Colour	Fender ø	Fender L	UM	€
3813101	A1	BLUE NAVY	28<>31 cm	36<>39 cm	PCS	
3813102	A2	BLUE NAVY	38<>41 cm	48<>51 cm	PCS	
3813103	A3	BLUE NAVY	46<>50 cm	58<>62 cm	PCS	
3813104	A4	BLUE NAVY	54<>60 cm	68<>73 cm	PCS	
3813105	A5	BLUE NAVY	68<>76 cm	90<>95 cm	PCS	
3813106	A6	BLUE NAVY	84<>90 cm	115<>120 cm	PCS	
3813107	A7	BLUE NAVY	100<>110 cm	135<>145 cm	PCS	

3813101SA	A1	SAND	38<>41 cm	48<>51 cm	PCS	
3813102SA	A2	SAND	38<>41 cm	48<>51 cm	PCS	
3813103SA	A3	SAND	46<>50 cm	58<>62 cm	PCS	
3813104SA	A4	SAND	54<>60 cm	68<>73 cm	PCS	
3813105SA	A5	SAND	68<>76 cm	90<>95 cm	PCS	
3813106SA	A6	SAND	84<>90 cm	115<>120 cm	PCS	
3813107SA	A7	SAND	100<>110 cm	135<>145 cm	PCS	

3813101GY	A1	GREY	28<>31 cm	36<>39 cm	PCS	
3813102GY	A2	GREY	38<>41 cm	48<>51 cm	PCS	
3813103GY	A3	GREY	46<>50 cm	58<>62 cm	PCS	
3813104GY	A4	GREY	54<>60 cm	68<>73 cm	PCS	
3813105GY	A5	GREY	68<>76 cm	90<>95 cm	PCS	
3813106GY	A6	GREY	84<>90 cm	115<>120 cm	PCS	
3813107GY	A7	GREY	100<>110 cm	135<>145 cm	PCS	

3813101BK	A1	BLACK	28<>31 cm	36<>39 cm	PCS	
3813102BK	A2	BLACK	38<>41 cm	48<>51 cm	PCS	
3813103BK	A3	BLACK	46<>50 cm	58<>62 cm	PCS	
3813104BK	A4	BLACK	54<>60 cm	68<>73 cm	PCS	
3813105BK	A5	BLACK	68<>76 cm	90<>95 cm	PCS	
3813106BK	A6	BLACK	84<>90 cm	115<>120 cm	PCS	
3813107BK	A7	BLACK	100<>110 cm	135<>145 cm	PCS	

3813101BO	A1	RED WINE	28<>31 cm	36<>39 cm	PCS	
3813102BO	A2	RED WINE	38<>41 cm	48<>51 cm	PCS	
3813103BO	A3	RED WINE	46<>50 cm	58<>62 cm	PCS	
3813104BO	A4	RED WINE	54<>60 cm	68<>73 cm	PCS	
3813105BO	A5	RED WINE	68<>76 cm	90<>95 cm	PCS	
3813106BO	A6	RED WINE	84<>90 cm	115<>120 cm	PCS	
3813107BO	A7	RED WINE	100<>110 cm	135<>145 cm	PCS	



StanFender Fender Hangers

Plastic fender hangers for ropes and lifelines or 22/25 mm rail mount. Sold in 2 pcs packaging.

Code	Hanger Ref	UM	€
0332902	for Rail	PCS	
0332904	for Lifeline	PCS	

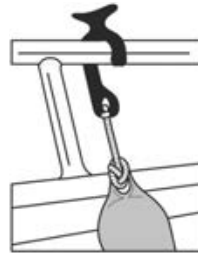

FlatFender Fender Hangers

Plastic fender hangers for 22/25 mm rail mount.

Code	UM	€
0332900	PR	

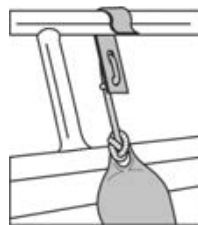

Fender Tender Holder Hook

Nylon UV resistant pair of universal fender holders. It clips with ease to any edge as side windows, handles, cleats, railings (22/25 mm) and lifelines (6/9 mm).

Code	UM	€
0332905	PR	

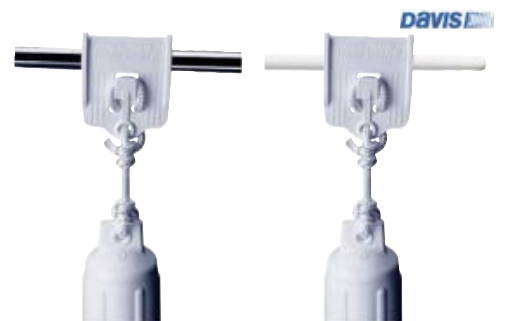

CroFender Fender Hangers

UV resistant Nylon with Stainless Steel secure spring fender hangers. Attaches onto 22 to 25 mm railings and 6 to 9 mm lifelines. Very easy fender mounting with GRIP lever height adjuster and ergonomic design with finger grooves for easy removal and relocation.

Code	UM	€
0332907	PR	



Fender Bride Lines 100MT

Fender Bride flat lines for hanging fenders made with high tenacity Polyester spun yarn of the same colour as the fendercovers. Light and robust, UV resistant. Sold in 100 meters reels.

Code	ø mm	Colour	Meters	UM	€
3105728100	8	BLUE NAVY	100	PCK	
3105730100	10	BLUE NAVY	100	PCK	
3105732100	12	BLUE NAVY	100	PCK	
3105734100	14	BLUE NAVY	100	PCK	
3105708100	8	WHITE	100	PCK	
3105710100	10	WHITE	100	PCK	
3105712100	12	WHITE	100	PCK	
3105714100	14	WHITE	100	PCK	
3105718100	8	BLACK	100	PCK	
3105720100	10	BLACK	100	PCK	
3105722100	12	BLACK	100	PCK	
3105724100	14	BLACK	100	PCK	



Fender Bride Lines

Fender Bride flat lines for hanging fenders made with high tenacity Polyester spun yarn of the same colour as the fendercovers. Light and robust, UV resistant.

Sold in 2 or 3 meters convenient packs.

Code	ø mm	Colour	Meters	UM	€
3105801	8	BLUE NAVY	2	PCS	
3105807	8	BLUE NAVY	3	PCS	
3105814	10	BLUE NAVY	2	PCS	
3105820	10	BLUE NAVY	3	PCS	
3105826	14	BLUE NAVY	2	PCS	
3105832	14	BLUE NAVY	3	PCS	
3105802	8	RED WINE	2	PCS	
3105808	8	RED WINE	3	PCS	
3105815	10	RED WINE	2	PCS	
3105821	10	RED WINE	3	PCS	
3105827	14	RED WINE	2	PCS	
3105833	14	RED WINE	3	PCS	
3105803	8	BLACK	2	PCS	
3105809	8	BLACK	3	PCS	
3105816	10	BLACK	2	PCS	
3105822	10	BLACK	3	PCS	
3105828	14	BLACK	2	PCS	
3105834	14	BLACK	3	PCS	
3105804	8	GREY	2	PCS	
3105810	8	GREY	3	PCS	
3105817	10	GREY	2	PCS	
3105823	10	GREY	3	PCS	
3105829	14	GREY	2	PCS	
3105835	14	GREY	3	PCS	
3105805	8	SAND	2	PCS	
3105811	8	SAND	3	PCS	
3105818	10	SAND	2	PCS	
3105824	10	SAND	3	PCS	
3105830	14	SAND	2	PCS	
3105836	14	SAND	3	PCS	



Fender Loop Lines

Fender loop lines with spliced eye for hanging fenders. Made from high strength Polyester.

Sold in pair in 2 or 3 meters convenient packs.

Code	ø mm	Colour	Meters	UM	€
3106701	8	WHITE	2	PR	
3106702	10	WHITE	2	PR	
3106703	12	WHITE	2	PR	
3106705	8	WHITE	3	PR	
3106706	10	WHITE	3	PR	
3106707	12	WHITE	3	PR	
3106711	8	BLACK	2	PR	
3106712	10	BLACK	2	PR	
3106713	12	BLACK	2	PR	
3106715	8	BLACK	3	PR	
3106716	10	BLACK	3	PR	
3106717	12	BLACK	3	PR	
3106721	8	BLUE NAVY	2	PR	
3106722	10	BLUE NAVY	2	PR	
3106723	12	BLUE NAVY	2	PR	
3106725	8	BLUE NAVY	3	PR	
3106726	10	BLUE NAVY	3	PR	
3106727	12	BLUE NAVY	3	PR	



Classic Fender Holders

Stainless Steel classic fender holders with clamp connectors for bow ambos or railing mounting.

Code	Baskets	ø mm	UM	€
3819217	2	190	PCS	
3819222	2	230	PCS	
3819317	3	190	PCS	
3819322	3	230	PCS	

**Easy Modular Fender Holders**

316 Stainless Steel classic modular fender holders. Versatile fender storage solution with connectors that will make possible to fasten the baskets on railings in any combination. All you need for installation is a screw-driver, one or more baskets and one or more swiveling or parallel connectors. The swiveling connector is a 22/25 mm rail tubing clamp. The parallel connector connects several baskets together.

Code	Basket ø mm	Accessories	UM	€
3819417	170		PCS	
3819419	195		PCS	
3819421	215		PCS	
3819423	230		PCS	
3819425	250		PCS	
3819430	305		PCS	
3819415		Swiveling Connector	PCS	
3819414		Basket Parallel Connector	PCS	

**Nawa Modular Fender Holders**

NAWA modular fender holders made of high-grade electropolished 316 Stainless Steel. The most versatile fender storage solution with patented connectors that will make possible to fasten the baskets on any railing in any combination. All you need for installation is a screw-driver, one or more baskets and one or more swiveling or parallel connectors. The swiveling connector is a 22, 25, 30 or 32 mm rail tubing clamp. The parallel connector connects several baskets together.

Code	Basket ø mm	Accessories	UM	€
3819017	170		PCS	
3819019	195		PCS	
3819021	215		PCS	
3819023	230		PCS	
3819025	250		PCS	
3819030	305		PCS	
3819036	360		PCS	
3819400		Swiveling Connector ø 22 mm	PCS	
3819401		Swiveling Connector ø 25 mm	PCS	
3819402		Swiveling Connector ø 30 mm	PCS	
3819404		Swiveling Connector ø 32 mm	PCS	
3819403		Basket Parallel Connector	PR	



กาน้ำ

Nawa Fender Baskets Kit

The most versatile fender storage solution that will make possible to fasten the baskets on any railing in any combination. All you need for installation is a screw-driver. High quality 316 Stainless Steel NAWA modular fender Kit includes: 2 baskets for dia 170/190/215/230 mm fenders, 3 swiveling clamp connectors for 25 mm rail tubing and 2 parallel connectors to join two baskets together.

Code	Baskets ø mm	UM	€
3819117	2 x 170	PCK	
3819119	2 x 190	PCK	
3819121	2 x 215	PCK	
3819123	2 x 230	PCK	



กาน้ำ

Bowbuoy

Rugged PVC bowbuoy with three reinforced eyelets.

Code	A cm	B cm	C cm	D cm	Colour	UM	€
3800302	35	26	23	33	WHITE	PCS	
3800303	35	26	23	33	BLUE	PCS	
3800304	55	41	37	51	WHITE	PCS	
3800305	55	41	37	51	BLUE	PCS	

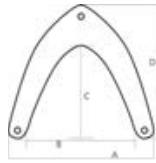

Bow Fender

Bow guard protection fender for sailboats when anchor is weighed or when bow berthing occurs. Sturdy PVC body for optimal shock absorption (it doesn't deflate, it doesn't contain air). Four line eyelets for a safe bow fix.

Code	Length cm	Width cm	Colour	UM	€
3803026	60	15	WHITE	PCS	
3803027	60	15	BLUE	PCS	



PVM1 Bow Guard

Transom/bow guardfender for sailing boats and catamarans, great protection when weighing the anchor or for bow and stern berthing. Sturdy Polyurethane mass for optimal shock absorption (it doesn't deflate, it doesn't contain air). Two line eyelets for a safe bow fix.

Code	Length cm	Width cm	H cm	UM	€
3803030	60	25	17	PCS	

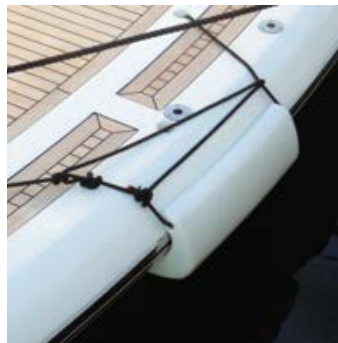

Safe Stern Guard

Fender designed for sailing boats transom protection. Matches perfectly any stern type 60<>75° or 75<>90°. Sturdy and soft Polyurethane mass for optimal shock absorption (it doesn't deflate, it doesn't contain air). The special shape and the line hole ensures great holding on any boat.

Code	Angle	Length cm	Width cm	H cm	Colour	UM	€
3803006	60<>75°	60	32	25	WHITE	PCS	
3803007	60<>75°	60	32	25	BLUE	PCS	
3803008	75<>90°	66	28	24	WHITE	PCS	
3803009	75<>90°	66	28	24	BLUE	PCS	



Stainless Steel Bow Plate

Easy to mount light and resistant Stainless Steel plate bow guard. Can be easily moulded by hand due to the splits cut.

Code	Type Ref	Width cm	H cm	UM	€
3800310	Elliptical	26,5	34,5	PCS	
3800311	Triangular	35,0	34,5	PCS	
3800312	U-Bolt Hole	27,0	32,0	PCS	



EVA Bumper B70 Finger

B70 modular and thin bumper for berths, pontoons, fingers and haulage docks. Made of extra strong E.V.A. soft foam that recovers its original shape even if hardly bented. Weathering, oils and solvents resistant.

Code	L cm	H cm	>cm<	UM	€
3800652	80	14	4	PCS	

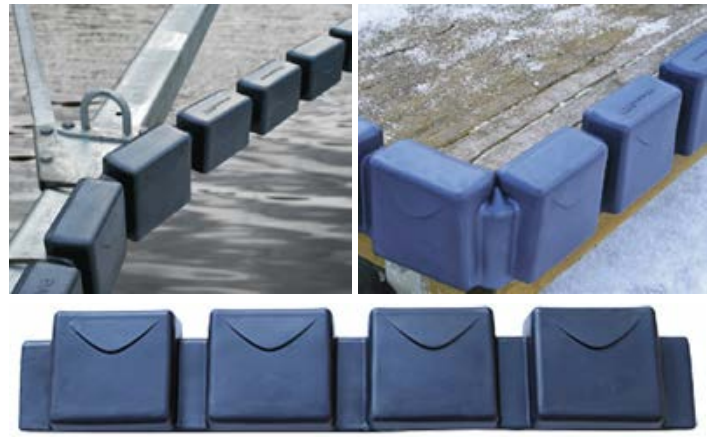

1 ANCHORING/MOORING/FENDERS BUOYS

EVA Bumper B80/90

B80/90 long and slim bumper for berths, pontoons, fingers and haulage docks. Made of extra strong E.V.A. soft foam that recovers its original shape even if hardly bented. Weathering, oils and solvents resistant.

Code	Ref	L cm	H cm	>cm<	UM	€
3800653	Linear	85	12	8	PCS	
3800654	Corner	85	12	8	PCS	
3800655	Linear	95	18	12	PCS	
3800658	Corner	95	18	12	PCS	



EVA Bumper B60/100

B60/100 large compact bumper for berths, pontoons and haulage docks. Made of extra strong E.V.A. soft foam that recovers its original shape even if hardly bented. Weathering, oils and solvents resistant.

Code	L cm	H cm	>cm<	UM	€
3800651	60	35	18	PCS	
3800656	95	35	18	PCS	



EVA Bumper BC60 Corner

BC60 corner bumper, offers perfect protection for pontoons, berths and docks' corners and edges. Made of extra strong E.V.A. soft foam that recovers its original shape even if hardly bented. Weathering, oils and solvents resistant.

Code	L cm	H cm	>cm<	UM	€
3800660	30	60	13	PCS	



Straight Dock Guard

Protection guard for jetty sides and boats.

Code	L mm	H mm	Colour	UM	€
3800501	250	60	WHITE	PCS	
3800502	250	60	BLUE	PCS	
3800601	500	60	WHITE	PCS	
3800602	500	60	BLUE	PCS	

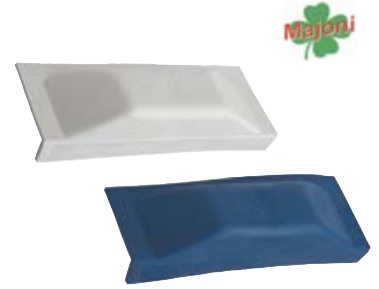
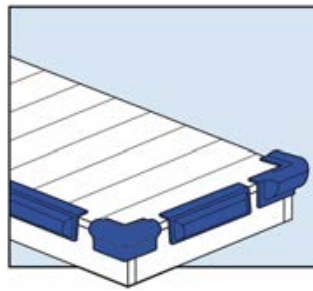

Angled Dock Guard

25 + 25 cm angled guard for boat and jetty edges protection.

Code	H mm	L mm	Colour	UM	€
3800403	60	250+250	WHITE	PCS	
3800404	60	250+250	BLUE	PCS	

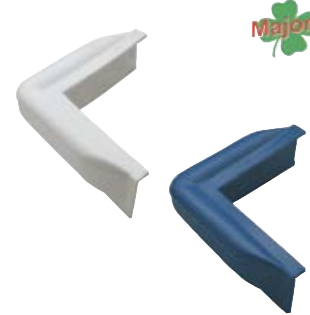
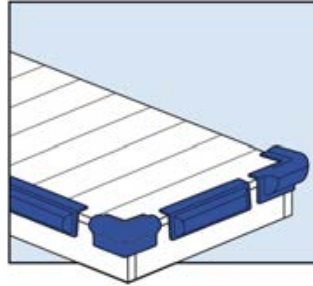

Long Block Dock Fender

Long guardfender for jetty sides, piers, fingers protection. Pressure regulation valve included.

Code	L cm	H cm	Thickness cm	UM	€
3800605	100	12	7	PCS	

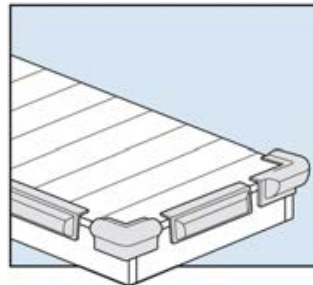

Bumper Maxi Dock Fender

Big guardfender for docks and marinas protection. Pressure regulation valve included.

Code	L cm	H cm	Thickness cm	UM	€
3837501	110	24	24	PCS	

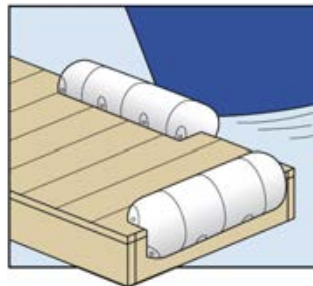

Bumper Folding Dock Fender

Folding bumper for dock edges and corners protection. Pressure regulation valve included.

Code	L cm	H cm	Thickness cm	UM	€
3837500	100	19	19	PCS	

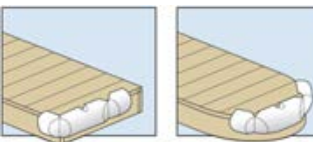

Dockwheel Dock Guard

Dockwheel protection PVC guard for docks. Support not included. It allows smooth passing of boats during mooring.

Code	ø mm	H mm	UM	€
3800610	300	150	PCS	

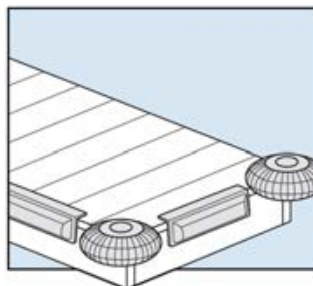

UltraGard Dock Edge Protection Bumper

Protection bumper for docks, pontoons and for any protection application. Can be mounted also on masts and slightly rounded surfaces. Constructed of marine grade UV and salt resistant PVC. Unaffected by oil, treated with fungicides, does not fade or deteriorate and it does not mark the boat's gel-coat.

Code	L cm	H cm	Thickness cm	Colour	UM	€
3800830	89	12,7	5,7	WHITE	PCS	
3800831	89	12,7	5,7	BLACK	PCS	



DOCK EDGE

Flex Dock Edge Protection Bumper

Flexible protection bumper for docks, pontoons and for any protection application. Can be mounted also on masts and rounded surfaces. Constructed of marine grade UV and salt resistant PVC. Unaffected by oil, treated with fungicides, does not fade or deteriorate and it does not mark the boat's gel-coat. High impact resistance thanks to the closed inner tube air system.

Code	L m	H cm	Thickness cm	UM	€
3800808	1,80	15,2	8	PCS	



DOCK EDGE

Guard Dock Edge Protection Profile

Protection profile for docks, pontoons and for any protection application. Constructed of marine grade UV and salt resistant PVC. Unaffected by oil, treated with fungicides, does not fade or deteriorate and it does not mark the boat's gel-coat.

Code	L m	H mm	Thickness mm	UM	€
3800806	3,00	73	19	PCS	



DOCK EDGE

P Type Dock Edge Protection Profile

Protection profile for docks, pontoons and for any protection application. Constructed of marine grade UV and salt resistant PVC. Unaffected by oil, treated with fungicides, does not fade or deteriorate and it does not mark the boat's gel-coat. To be completed with accessories to ensure high impact resistance thanks to the closed inner tube air system. Packed 4 pieces 2,40 meters each.

Code	Ref	L m	H mm	Accessories	UM	€
3800811	DE P Type Profile	4 x 2,40	95		PCK	
3800813				Pair of Connectors	PR	
3800814				Pair of Corners	PR	
3800815				Pair of End Caps	PR	



DOCK EDGE

DD Type Dock Edge Protection Profile

Protection profile for docks, pontoons and for any protection application. Constructed of marine grade UV and salt resistant PVC. Unaffected by oil, treated with fungicides, does not fade or deteriorate and it does not mark the boat's gel-coat. To be completed with accessories to ensure high impact resistance thanks to the closed inner tube air system. Packed 5 pieces 2,40 meters each.

Code	Ref	L m	H mm	Accessories	UM	€
3800821	DE DD Type Profile	5 x 2,40	127		PCK	
3800823				Pair of Connectors (4pcs)	PR	
3800824				Pair of Corners (4pcs)	PR	
3800825				Pair of End Caps (4pcs)	PR	



DOCK EDGE

PVC Dock Fender

3 Meters long fendering profiles for docks, pontoons and general purpose protection. Produced from high impact resistance PVC with a very low friction coefficient, it does not mark the boat's gel-coat as instead the rubber does. It can be set individually or in multiples. Fixing: insert a 30x5 mm Aluminum or a Zinc-plated plate and pierce to introduce the fixing screws.

Code	L m	H mm	UM	€
3834060	3	60	PCS	
3834090	3	90	PCS	

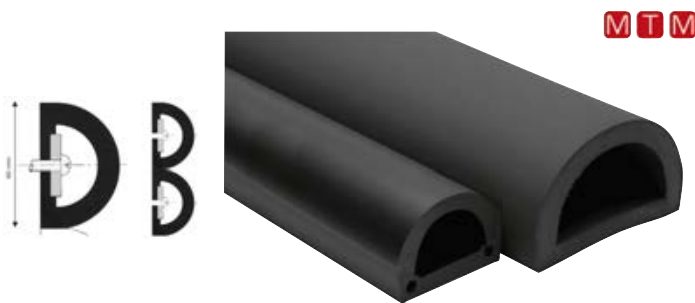

- FENDERING PROFILES -

Bino Fendering Profile

Strong and lightweight fendering profile that is suitable for protection of workboats, docks and piers due to its sturdy structure. Easy installation with base profile and pre-drilled Stainless Steel bar, while the top side is simply pressure fixed.

Code	H mm	Colour	Pack	Accessories	UM	€
383276512	65	BLACK	12 m		PCK	
383276612	65	WHITE	12 m		PCK	
383279012	90	BLACK	12 m		PCK	
383279112	90	WHITE	12 m		PCK	
383280002				2 Meters S/Steel Bar	PCK	

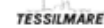

T Rub Rails

T shaped PVC fendering profile. T1 or T2 strip support is needed for mounting. The profile is sold in 12, 16 and 24 meters pack. The end cap, the finishing joint and the strip support are available according to the height of the profile and colour.

Code	gr/m	H mm	Colour	Pack	Accessories	UM	€
383003512	1200	36	BLACK	12 m		PCK	
383003516	1200	36	BLACK	16 m		PCK	
383003524	1200	36	BLACK	24 m		PCK	
383013512	1200	36	WHITE	12 m		PCK	
383013516	1200	36	WHITE	16 m		PCK	
383013524	1200	36	WHITE	24 m		PCK	
383011802					2 m T1 Strip for H36	PCS	
3833035					BLACK End-Cap	PCS	
3833528					BLACK Finishing Joint	PCS	
3833135					WHITE End-Cap	PCS	
3833628					WHITE Finishing Joint	PCS	
383004512	1600	45	BLACK	12 m		PCK	
383004516	1600	45	BLACK	16 m		PCK	
383004524	1600	45	BLACK	24 m		PCK	
383014512	1600	45	WHITE	12 m		PCK	
383014516	1600	45	WHITE	16 m		PCK	
383014524	1600	45	WHITE	24 m		PCK	
383012202					2 m T2 Strip for H45	PCS	
3833045					BLACK End-Cap	PCS	
3833545					BLACK Finishing Joint	PCS	
3833145					WHITE End-Cap	PCS	
3833645					WHITE Finishing Joint	PCS	



EC01 Fendering Profile

PVC fendering profile to finish joint edges between deck and hull. The profile is sold in 12, 16 and 24 meters pack. The end cap and the finishing joint are available according to the type of the profile and colour.

Code	gr/m	H mm	Colour	Pack	Accessories	UM	€
383002812	600	25	BLACK	12 m		PCK	
383002816	600	25	BLACK	16 m		PCK	
383002824	600	25	BLACK	24 m		PCK	
3833028					BLACK End Cap	PCS	
3833528					BLACK Finishing Joint	PCS	
383012812	600	25	WHITE	12 m		PCK	
383012816	600	25	WHITE	16 m		PCK	
383012824	600	25	WHITE	24 m		PCK	
3833128					WHITE End Cap	PCS	
3833628					WHITE Finishing Joint	PCS	



TESSILMARE

EC02 Fendering Profile

PVC fendering profile to finish joint edges between deck and hull. The profile is sold in 12, 16 and 24 meters pack. The end cap and the finishing joint are available according to the type of the profile and colour.

Code	gr/m	H mm	Colour	Pack	Accessories	UM	€
383003012	550	25	BLACK	12 m		PCK	
383003016	550	25	BLACK	16 m		PCK	
383003024	550	25	BLACK	24 m		PCK	
3833028					BLACK End Cap	PCS	
3833528					BLACK Finishing Joint	PCS	
383013012	550	25	WHITE	12 m		PCK	
383013016	550	25	WHITE	16 m		PCK	
383013024	550	25	WHITE	24 m		PCK	
3833128					WHITE End Cap	PCS	
3833628					WHITE Finishing Joint	PCS	



TESSILMARE

U Flat Rub Rails

PVC fendering profile to protect the flat sides of the boat. U2 fixing strip support is needed for mounting. The end cap and the finishing joint are available according to colour.

Code	gr/m	H mm	Colour	Pack	Accessories	UM	€
383104012	1200	40	BLACK	12 m		PCK	
383104016	1200	40	BLACK	16 m		PCK	
383104024	1200	40	BLACK	24 m		PCK	
383114012	1200	40	WHITE	12 m		PCK	
383114016	1200	40	WHITE	16 m		PCK	
383114024	1200	40	WHITE	24 m		PCK	
3833040					BLACK End-Cap H 40 mm	PCS	
3833540					BLACK Finishing Joint H 40 mm	PCS	
3833140					WHITE End-Cap H 40 mm	PCS	
3833640					WHITE Finishing Joint H 40 mm	PCS	
383022504					4 Meters U2 Support	PCK	



TESSILMARE



Aluminum Rub Rail Fendering Profile

Fendering profile with Anodized Aluminum rub rail. The Aluminum rub rail is in 4-meter bars and has to be chosen upon the desired height (H mm). The Black or White PVC insert is available in 12, 16 and 24 meters pack.

Code	Ref	Pack	Accessories	UM	€
3832037	ALU H37 mm Rub Rail	4 m		MT	
383213712	BLACK PVC Insert	12 m		PCK	
383213716	BLACK PVC Insert	16 m		PCK	
383213724	BLACK PVC Insert	24 m		PCK	
3833837			BLACK Plastic End Cap	PCS	
3833537			BLACK Plastic Joint	PCS	
383223712	WHITE PVC Insert	12 m		PCK	
383223716	WHITE PVC Insert	16 m		PCK	
383223724	WHITE PVC Insert	24 m		PCK	
3833937			WHITE Plastic End Cap	PCS	
3833637			WHITE Plastic Joint	PCS	
3832055	ALU H57 mm Rub Rail	4 m		MT	
383215612	BLACK PVC Insert	12 m		PCK	
383215616	BLACK PVC Insert	16 m		PCK	
383215624	BLACK PVC Insert	24 m		PCK	
3833856			BLACK Plastic End Cap	PCS	
3833556			BLACK Plastic Joint	PCS	
383225612	WHITE PVC Insert	12 m		PCK	
383225616	WHITE PVC Insert	16 m		PCK	
383225624	WHITE PVC Insert	24 m		PCK	
3833956			WHITE Plastic End Cap	PCS	
3833656			WHITE Plastic Joint	PCS	



Sphaera Stainless Steel Fendering Profile

High-tech revolutionary fender profile with exclusive finishes, sturdy, lightweight and easy to bent. The inner Duralene filling distinguishes these profiles for an easy shaping on the sides, while the PVC flexible base eliminates the joining problems between traditional PVC rigid bars. There are two type of end caps: one for profiles with PVC base and one for profiles without PVC base. The joint needs to be mounted every 3 meters in length of the profile.

Code	Sphaera Profile	Accessories	UM	€
383250203	3 mt H25 mm		PCK	
383250112		Black PVC Slim Base H30 mm x 12 Meters	PCK	
383250113		White PVC Slim Base H30 mm x 12 Meters	PCK	
383250212		Black PVC Standard Base H40 mm x 12 Meters	PCK	
383250213		White PVC Standard Base H40 mm x 12 Meters	PCK	
3833502		Joint	PCS	
3833512		Pair of End Caps for Profile with Standard Base	PCK	
3833522		End Cap for Profiles with Slim Base or without Base	PCS	
383250403	3 mt H35 mm		PCK	
383250312		Black PVC Slim Base H40 mm x 12 Meters	PCK	
383250313		White PVC Slim Base H40 mm x 12 Meters	PCK	
383250412		Black PVC Standard Base H50 mm x 12 Meters	PCK	
383250413		White PVC Standard Base H50 mm x 12 Meters	PCK	
3833504		Joint	PCS	
3833514		Pair of End Caps for Profiles with Standard Base	PCK	
3833524		End Cap for Profiles with Slim Base or without Base	PCS	
383250603	3 mt H50 mm		PCK	
383250512		Black PVC Slim Base H55 mm x 12 Meters	PCK	
383250513		White PVC Slim Base H55 mm x 12 Meters	PCK	
383250612		Black PVC Standard Base H70 mm x 12 Meters	PCK	
383250613		White PVC Standard Base H70 mm x 12 Meters	PCK	
3833506		Joint	PCS	
3833516		Pair of End Caps for Profiles with Standard Base	PCK	
3833526		End Cap for Profiles with Slim Base or without Base	PCS	

Standard base

Slim base



Standard base

Slim base



No base mount



Slim base mount



Standard base mount



Radial Fendering Profile

Radial is the only PVC fendering profile easy and quick to install that can be cold fitted in a few quick steps. Its flexibility and handling make the Radial profile unique. The profile is supplied in 12 - 16 - 24 meters rolls with a H height of 30 - 40 - 52 - 65 - 85 mm. It is available in Black - White - Grey colours. The end caps and joints are available in plastic in the same colour of the profile, or in Stainless Steel. The rigid support tracks are sold in 2 meter bars.

Code	H mm	Colour	Pack	Accessories	UM	€
383230312	30	BLACK	12 meters		PCK	
383230316	30	BLACK	16 meters		PCK	
383230324	30	BLACK	24 meters		PCK	
383233302				2 Meters Track	PCS	
3833303				BLACK Plastic End Cap	PCS	
3833313				BLACK Plastic Joint	PCS	
383231312	30	WHITE	12 meters		PCK	
383231316	30	WHITE	16 meters		PCK	
383231324	30	WHITE	24 meters		PCK	
383233302				2 Meters Track	PCS	
3833304				WHITE Plastic End Cap	PCS	
3833314				WHITE Plastic Joint	PCS	
383232312	30	GREY	12 meters		PCK	
383232316	30	GREY	16 meters		PCK	
383232324	30	GREY	24 meters		PCK	
383233302				2 Meters Track	PCS	
3833305				GREY Plastic End Cap	PCS	
3833315				GREY Plastic Joint	PCS	
383230412	40	BLACK	12 meters		PCK	
383230416	40	BLACK	16 meters		PCK	
383230424	40	BLACK	24 meters		PCK	
383233402				2 Meters Track	PCS	
3833035				BLACK Plastic End Cap	PCS	
3833531				BLACK Plastic Joint	PCS	
3833203				S/STEEL End Cap	PCS	
3833209				S/STEEL Joint	PCS	
383231412	40	WHITE	12 meters		PCK	
383231416	40	WHITE	16 meters		PCK	
383231424	40	WHITE	24 meters		PCK	
383233402				2 Meters Track	PCS	
3833135				WHITE Plastic End Cap	PCS	
3833631				WHITE Plastic Joint	PCS	
3833203				S/STEEL End Cap	PCS	
3833209				S/STEEL Joint	PCS	
383232412	40	GREY	12 meters		PCK	
383232416	40	GREY	16 meters		PCK	
383232424	40	GREY	24 meters		PCK	
383233402				2 Meters Track	PCS	
3833202				GREY Plastic End Cap	PCS	
3833208				GREY Plastic Joint	PCS	
3833203				S/STEEL End Cap	PCS	
3833209				S/STEEL Joint	PCS	
383230512	52	BLACK	12 meters		PCK	
383230516	52	BLACK	16 meters		PCK	
383230524	52	BLACK	24 meters		PCK	
383233502				2 Meters Track	PCS	
3833212				BLACK Plastic End Cap	PCS	
3833218				Black Plastic Joint	PCS	
3833215				S/STEEL End Cap	PCS	
3833221				S/STEEL Joint	PCS	
383231512	52	WHITE	12 meters		PCK	
383231516	52	WHITE	16 meters		PCK	
383231524	52	WHITE	24 meters		PCK	
383233502				2 Meters Track	PCS	
3833213				WHITE Plastic End Cap	PCS	
3833219				WHITE Plastic Joint	PCS	
3833215				S/STEEL End Cap	PCS	
3833221				S/STEEL Joint	PCS	
383232512	52	GREY	12 meters		PCK	
383232516	52	GREY	16 meters		PCK	
383232524	52	GREY	24 meters		PCK	
383233502				2 Meters Track	PCS	
3833214				GREY Plastic End Cap	PCS	
3833220				GREY Plastic Joint	PCS	
3833215				S/STEEL End Cap	PCS	
3833221				S/STEEL Joint	PCS	



TESSILMARE

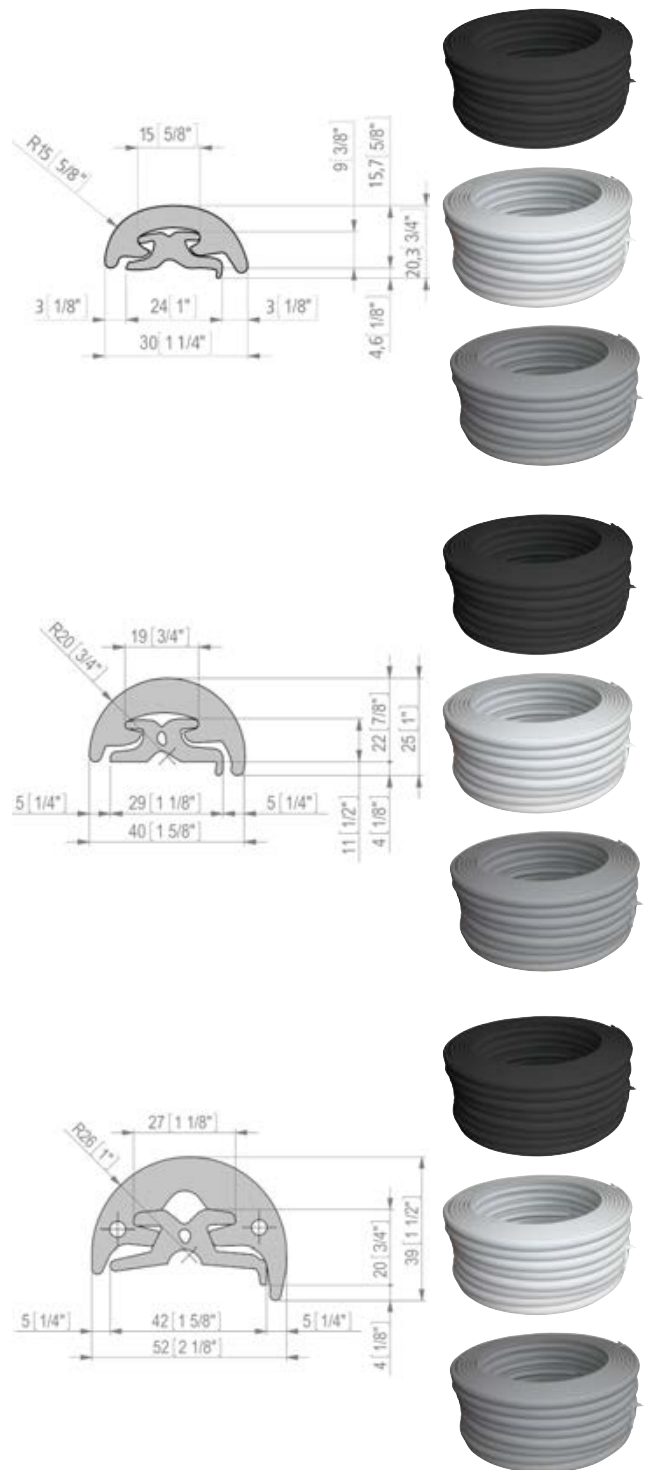

BUMPERS / PROTECTION GUARDS / FENDERING PROFILES

FENDERING PROFILES

Code	H mm	Colour	Pack	Accessories	UM	€
383230616	65	BLACK	16 meters		PCK	
383230624	65	BLACK	24 meters		PCK	
383233602				2 Meters Track	PCS	
3833212				BLACK Plastic End Cap	PCS	
3833218				BLACK Plastic Joint	PCS	
3833216				S/STEEL End Cap	PCS	
3833222				S/STEEL Joint	PCS	
383231616	65	WHITE	16 meters		PCK	
383231624	65	WHITE	24 meters		PCK	
383233602				2 Meters Track	PCS	
3833213				WHITE Plastic End Cap	PCS	
3833219				WHITE Plastic Joint	PCS	
3833216				S/STEEL End Cap	PCS	
3833222				S/STEEL Joint	PCS	
383232616	65	GREY	16 meters		PCK	
383232624	65	GREY	24 meters		PCK	
383233602				2 Meters Track	PCS	
3833214				GREY Plastic End Cap	PCS	
3833220				GREY Plastic Joint	PCS	
3833216				S/STEEL End Cap	PCS	
3833222				S/STEEL Joint	PCS	
383230816	85	BLACK	16 meters		PCK	
383230824	85	BLACK	24 meters		PCK	
383233802				2 Meters Track	PCS	
3833230				Pair of S/STEEL End Caps	PR	
3833235				S/STEEL Joint	PCS	
383231816	85	WHITE	16 meters		PCK	
383231824	85	WHITE	24 meters		PCK	
383233802				2 Meters Track	PCS	
3833230				Pair of S/STEEL End Caps	PR	
3833235				S/STEEL Joint	PCS	
383232816	85	GREY	16 meters		PCK	
383232824	85	GREY	24 meters		PCK	
383233802				2 Meters Track	PCS	
3833230				Pair of S/STEEL End Caps	PR	
3833235				S/STEEL Joint	PCS	

