

3

LADDERS GANGWAYS /  
STAFFS SEATS /  
PORT LIGHTS AIR VENTS



M T M

**Eco Boarding Ladders**

Nylon rope structure and reinforced Plastic steps boarding ladders. Step width 31 cm.

Code	Steps	UM	€
0502030	3	PCS	
0502040	4	PCS	
0502045	5	PCS	



**Adjustable Arms Gunwale Ladders**

Adjustable arms gunwale-mount boarding ladders. 25mm Anodized Aluminum tubing with non-slip plastic steps and with adjustable and removable spacers. W=26 cm. Width 37 cm.

Code	Steps	H cm	Spare Parts	UM	€
0502513	3	90		PCS	
0502514	4	119		PCS	
0502515	5	146		PCS	
0502600			Step	PCS	
0502601			Standoff	PR	
0502602			Tip	PCS	

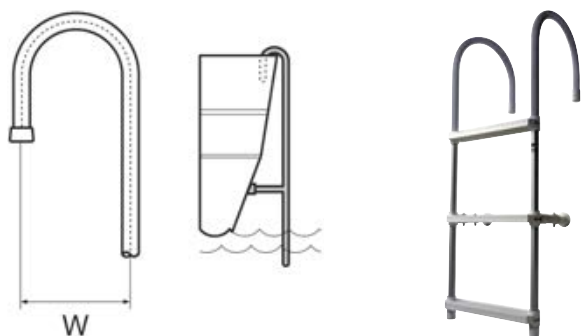

**Hidden Safety Ladders**

Nylon braid structure hidden emergency boarding ladders with 3 high-resistance Thermopolymer steps and one handle. To be installed above the waterline into recessed watertight Thermopolymer housing. Very simple to use: the man overboard pulls the locking cap ring to let the ladder out.

Code	Mounting	L cm	Steps	Recess ø	Recess L	UM	€
0502106	Front Screws	115	3+1	55 mm	195 mm	PCS	
0502107	Rear Nut	115	3+1	55 mm	195 mm	PCS	



**Ladders for Inflatables**

Anodized Aluminum folding boarding ladders for inflatables. Two fastening spliced ropes included.

Code	Steps	H cm	UM	€
0505503	3	93	PCS	
0505504	4	113	PCS	



**Gunwale Bow Ladders**

Stainless Steel folding gunwale mount bow ladders with adjustable standoff.

Code	Steps	H cm	UM	€
0505201	3	80	PCS	
0505204	4	110	PCS	
0505205	5	130	PCS	

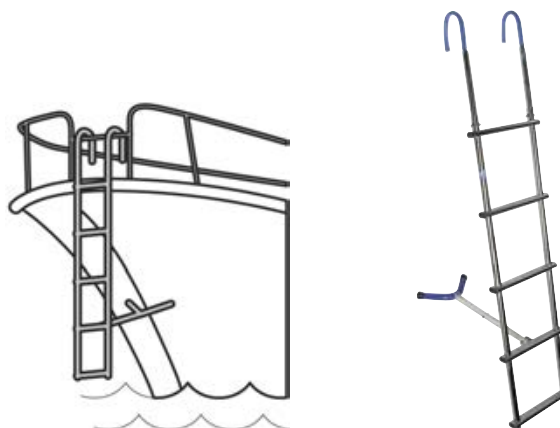

**Safety Ladder**

Plastic steps and rope safety boarding ladder stored in a portable bag. Ready to use, it has to be dropped off the boat to safely get back aboard. Polyester straps and reinforced ABS steps.

Code	Steps	Steps H cm	Total H cm	UM	€
0502105	5	110	220	PCS	



**Handle Steps**

Stainless Steel handle/step with or without Wood footrest.

Code	Ref	cm	UM	€
<b>0504000</b>	Stainless Steel	30 x 12,5	PCS	
<b>0504001</b>	Wood and Stainless Steel	30 x 12,5	PCS	

**Stainless Steel Folding Step**

Elegant, sturdy and easy to mount Stainless Steel folding step.

Code	Base mm	Step Width mm	Wheelbase mm	UM	€
<b>0504003</b>	50 x 118	115	100	PCS	

**Mast Steps**

Extremely light and resistant Nylon/Glass Fiber folding mast step. UV resistant, amagnetic, aerodynamic. Max load 140 Kg.

Code	Colour	Weight Kg	L Open mm	L Closed mm	UM	€
<b>0504010</b>	BLACK	0,16	157	35	PCS	
<b>0504011</b>	WHITE	0,16	157	35	PCS	
<b>0504012</b>	GREY	0,16	157	35	PCS	

**- TELESCOPIC LADDERS -****Diver Double Axe Telescopic Ladders**

Telescopic foldable mirror-polished Stainless Steel ladders with double central axe. Easy boarding with fins and heavy gear thanks to the free steps on both sides.

Code	Steps	H Open cm	H Closed cm	W cm	UM	€
<b>0505443</b>	3	87	39	35	PCS	
<b>0505444</b>	4	115	44	35	PCS	

**Diver Single Axe Telescopic Ladders**

Telescopic foldable electropolished Stainless Steel ladders. Easy boarding for swimmers or divers with fins and heavy gear thanks to the central support and steps free on both sides.

Code	Steps	H Open cm	H Closed cm	W cm	UM	€
<b>0505453</b>	3	87	45	34	PCS	
<b>0505454</b>	4	112	52	34	PCS	



**Up Telescopic Ladders**

Stainless Steel folding telescopic over platform ladders.

Code	Steps	H cm	W cm	L cm	UM	€
<b>0505403</b>	3	88	29	38	PCS	
<b>0505404</b>	4	115	29	40	PCS	

**Up Wide Telescopic Ladders**

Stainless Steel fold-away boarding ladders with wide steps for a comfortable climb back up.

Under platform mounting.

Code	Steps	H cm	W cm	L cm	UM	€
<b>0505413</b>	3	87,5	25	37	PCS	
<b>0505414</b>	4	115	25	39,5	PCS	

**In Cage Slim Telescopic Ladders**

Stainless Steel fold-away under platform boarding ladders. Complete with cage and guide rails.

Code	Steps	H cm	W cm	L cm	UM	€
<b>0505313</b>	3	88	23	38	PCS	
<b>0505314</b>	4	115	23	40	PCS	

**Up Slim Telescopic Ladders**

Stainless Steel folding telescopic over platform slim ladders.

Code	Steps	H cm	W cm	L cm	UM	€
<b>0505433</b>	3	88	20	38	PCS	
<b>0505434</b>	4	115	20	40	PCS	

**In Cage Telescopic Ladders**

Stainless Steel fold-away under platform boarding ladders. Complete with cage and guide rails.

Code	Steps	H cm	W cm	L cm	UM	€
<b>0505303</b>	3	88	31	38	PCS	
<b>0505304</b>	4	115	31	40	PCS	

**In Cage Wide Step Telescopic Ladders**

Stainless Steel fold-away under platform boarding ladders with wide steps for a comfortable climb back up. Complete with cage and guide rails.

Code	Steps	H cm	W cm	L cm	UM	€
<b>0505306</b>	3	87,5	25	37	PCS	
<b>0505308</b>	4	114,5	25	40,5	PCS	

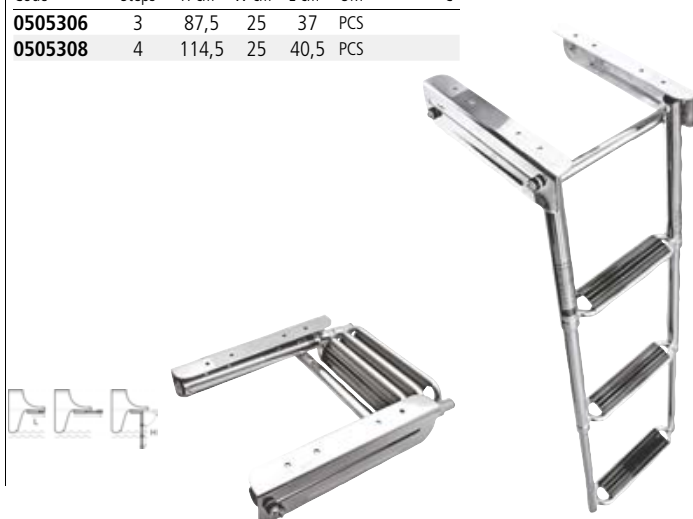

**In Box Telescopic Ladders**

Stainless steel in box telescopic ladders. Complete with box and guide rails. Flush transom-mount. Box dimensions 33 x 47 x 4,6 cm (49 cm for the 4-step version).

Code	Steps	H cm	W cm	UM	€
<b>0505323</b>	3	87	25	PCS	
<b>0505324</b>	4	115	25	PCS	

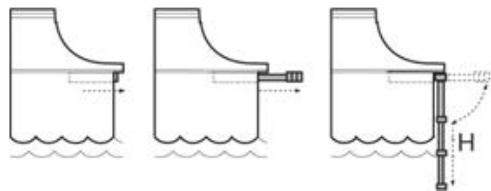
**Up Handrail Telescopic Ladders**

Stainless Steel telescopic over platform ladders with handrail. Handrail dimensions W36 x H20.

Code	Steps	H cm	W cm	UM	€
<b>0505333</b>	3	89	26	PCS	
<b>0505334</b>	4	115	26	PCS	

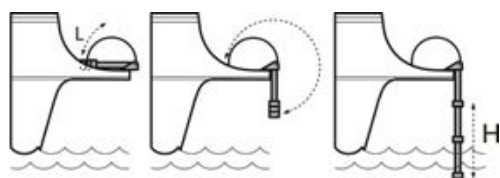
**Folding Handrail Up Telescopic Ladders**

Stainless Steel telescopic fold-away boarding ladders with folding handrail. For platform mount. Handrail dimensions 30 cm.

Code	Steps	H cm	W cm	L cm	UM	€
<b>0505344</b>	4	112	30	41,6	PCS	

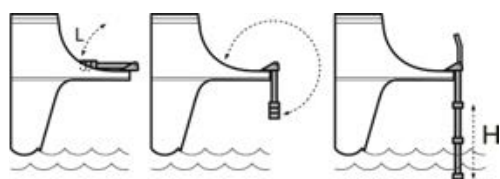
**Curved Inflatable Boats Ladders**

Stainless Steel telescopic folding ladders for inflatable boats. Complete with fixing straps.

Code	Steps	H cm	W cm	L cm	UM	€
<b>0505463</b>	3	87	25	37	PCS	
<b>0505464</b>	4	118	25	39,5	PCS	



**S/Steel Standard Ladders**

Stainless Steel standard transom folding ladders. Antislip coated composite step tread.

Code	Steps	W cm	H cm	UM	€
<b>0503103</b>	3	24	65	PCS	
<b>0503104</b>	4	24	88	PCS	
<b>0503105</b>	5	24	110	PCS	

**S/Steel and Wood Standard Ladders**

Stainless Steel standard transom folding ladders. Treated Wood upper step tread.

Code	Steps	W cm	H cm	UM	€
<b>0503603</b>	3	24	65	PCS	
<b>0503604</b>	4	24	88	PCS	
<b>0503605</b>	5	24	110	PCS	

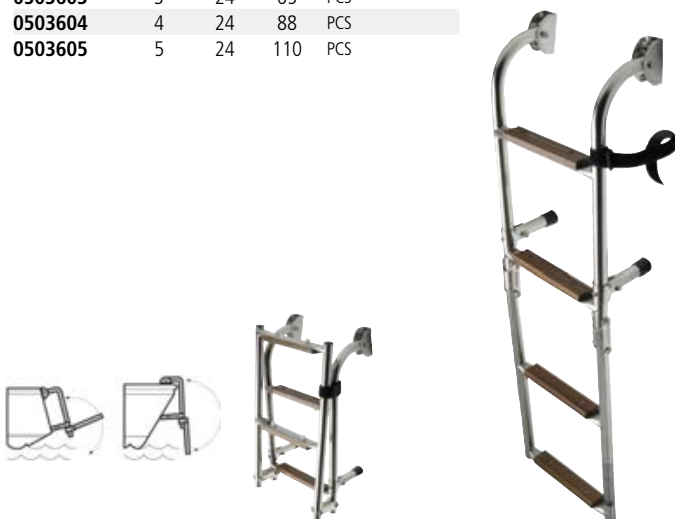
**S/Steel Handrail Ladders**

Stainless Steel folding handrail boarding ladders.

H: height with open ladder

H1: height with closed ladder

Code	Steps	W cm	H/H1	UM	€
<b>0504903</b>	3	23	67/38	PCS	
<b>0504904</b>	4	23	91/55	PCS	
<b>0504905</b>	5	23	115/57	PCS	

**S/Steel Mini Ladders**

Stainless Steel narrow transom folding ladders. Antislip coated composite step tread. Used when there is no space in the transom.

Code	Steps	W cm	H cm	UM	€
<b>0503003</b>	3	22	65	PCS	
<b>0503004</b>	4	22	88	PCS	

**S/Steel and Wood Mini Ladders**

Stainless Steel narrow folding transom ladders. Treated Wood step tread. Used when there is no space in the transom.

Code	Steps	W cm	H cm	UM	€
<b>0502803</b>	3	20	55	PCS	
<b>0502804</b>	4	20	75	PCS	

**S/Steel and Wood Handrail Ladders**

Stainless Steel folding handrail boarding ladders.

Treated Wood step tread.

H: height with open ladder

H1: height with closed ladder

Code	Steps	W cm	H/H1	UM	€
<b>0505003</b>	3	23	67/38	PCS	
<b>0505004</b>	4	23	91/55	PCS	
<b>0505005</b>	5	23	115/57	PCS	



**S/Steel Flat Mount Ladders**

Stainless Steel platform boarding folding ladder. Transom platform mount.

Code	Steps	W cm	H/H1	UM	€
0504513	3	24	82/49	PCS	
0504514	4	24	99/58	PCS	



**Scalette Inox e Legno con Attacco Piano**

Stainless Steel platform boarding folding ladder. Treated Wood step tread. Transom platform mount.

Code	Steps	W cm	H/H1	UM	€
0504503	3	23,5	75/41	PCS	
0504504	4	23,5	91/50	PCS	



**S/Steel Clamp Mount Ladders**

Stainless Steel folding boarding ladders with clamps for ø 22/25 mm tubing.

Code	Steps	W cm	H cm	UM	€
0505903	3	21	66	PCS	
0505904	4	23	90	PCS	



**S/Steel and Wood Clamp Mount Ladders**

Stainless Steel folding boarding ladders with clamps for ø 22/25 mm tubing. Treated Wood step tread.

Code	Steps	W cm	H cm	UM	€
0506003	3	27	63	PCS	
0506004	4	24	92	PCS	



- TINOX TRANSOM PLATFORMS -

**Minox Platforms**

Stainless Steel transom swim platforms with marine wood planks.

Code	mm	UM	€
0510700	270 x 390	PCS	
0510900	390 x 450	PCS	



**Tinox Platforms**

316 Stainless Steel transom swim platforms with Doussie marine grade wood planks.

Code	mm	Accessories	UM	€
0511403	400 x 460		PCS	
0511503	520 x 490		PCS	
0521300		Outboard Bracket	PCS	

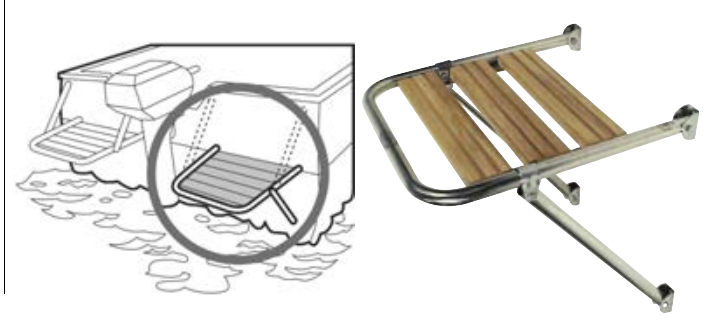

LADDERS GANGWAYS/STAFFS SEATS/PORT LIGHTS AIR VENTS

**Minox Platforms with Ladder**

Stainless Steel transom swim platforms with marine wood planks and folding ladder.

Code	mm	Steps	UM	€
0510701	270 x 390	2	PCS	
0510901	390 x 450	3	PCS	

**Minox Platforms with Outboard Bracket**

Stainless Steel transom swim platforms with marine wood planks and outboard bracket.

Code	mm	UM	€
0510702	270 x 390	PCS	
0510902	390 x 450	PCS	

**Tinox Mini Platforms**

316 Stainless Steel transom compact swim platforms with Doussie marine grade wood planks and folding ladder or outboard bracket.

Code	Ref	mm	UM	€
0511301	With Ladder	280 x 450	PCS	
0511302	With Outboard Bracket	280 x 450	PCS	

**Tinox Platforms with Ladder**

316 Stainless Steel transom swim platforms with Doussie marine grade wood planks and 3 step folding ladder.

Code	mm	UM	€
0511401	410 x 450	PCS	
0511501	500 x 460	PCS	

**Swim Transom Platform**

Stainless Steel transom platform with reinforced Plastic base and 3 steps telescopic ladder.

Code	mm	UM	€
0510801	350 x 450	PCS	

**Large Transom Platforms**

316 Stainless Steel frame and Doussie marine grade wood planks large transom swim platform.

Code	mm	Accessories	UM	€
0511015	1500 x 550		PCS	
0511017	1700 x 550		PCS	
0511020	2000 x 550		PCS	
0506003		3 Steps Ladder	PCS	
0521300		Outboard Bracket	PCS	





**Adjustable 6HP Outboard Bracket**

Spring-assisted action outboard motor bracket. For outboards up to 6HP.  
Stainless Steel body.

Code	For Outboards	Engine Kg	Plate	UM	€
<b>0520506</b>	< 6 HP	20	Wood	PCS	
<b>0520606</b>	< 6 HP	20	Plastic	PCS	

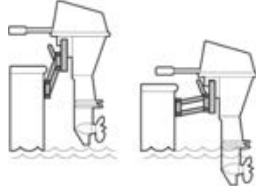
**Adjustable 15HP Outboard Bracket**

Spring-assisted action outboard motor bracket. For outboards up to 15HP (2 Stroke) or 8HP (4 Stroke). Stainless Steel body.

Code	For Outboards	Engine Kg	Plate	UM	€
<b>0520515</b>	< 15 HP (2 Stroke) - 8 HP (4 Stroke)	30	Wood	PCS	
<b>0520615</b>	< 15 HP (2 Stroke) - 8 HP (4 Stroke)	30	Plastic	PCS	

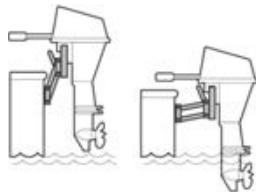
**V Adjustable 20HP Outboard Bracket**

Spring-assisted action outboard motor bracket with adjustable base angle. For outboards up to 20HP (2 Stroke) or 15 HP (4 Stroke).  
Stainless Steel body.

Code	For Outboards	Engine Kg	Plate	UM	€
<b>0520925</b>	< 25 HP (2 Stroke) - 15 HP (4 Stroke)	40	Wood	PCS	
<b>0520725</b>	< 20 HP (2 Stroke) - 15 HP (4 Stroke)	40	Plastic	PCS	

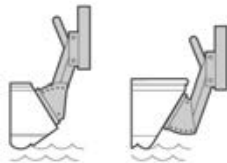
**Adjustable Plate for Outboard Brackets**

Stainless Steel adjustable plate for outboard brackets.

Code	UM	€
<b>0520550</b>	PCS	

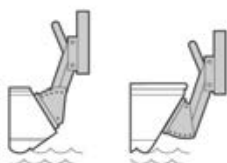

**Clamp Mount Outboard Bracket**

Stainless Steel hardware and Marine Plywood board outboard bracket. Double bladed band with through screw for platform mounting. Brackets' base length 250 mm.

Code	For Outboards	Max Kg	UM	€
0521300	< 10 HP	35	PCS	



**Standard Outboard Bracket**

Stainless Steel body and Marine Plywood adjustable board outboard bracket. Dimensions 270 x 150 x H170 mm.

Code	For Outboards	Max Kg	UM	€
0520828	< 10 HP	35	PCS	

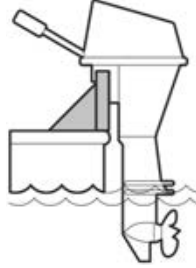

**Adjustable 22°/35° Outboard Bracket**

Transom-mount outboard bracket adjustable from 22° to 35°. Stainless Steel body and Marine Plywood pad.

Code	For Outboards	Max Kg	UM	€
0520826	< 10 HP	35	PCS	

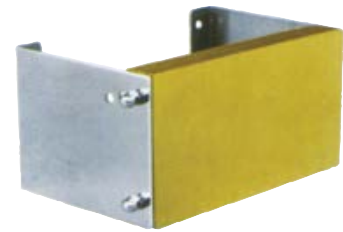
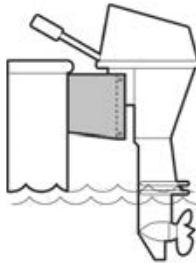

**Angled Outboard Bracket**

Stainless Steel body and Marine Plywood adjustable board outboard bracket.

Code	For Outboards	Max Kg	UM	€
0520827	< 10 HP	30	PCS	

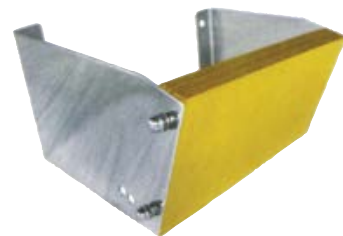
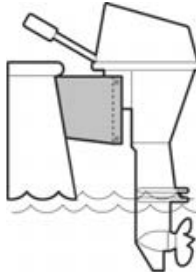

**Rail Mount L Outboard Bracket**

Marine Plywood pad rail mount bracket for small outboards. Stainless Steel pipe support and screws. Pad dimensions: 195 x H245 mm with 2 holes for 22/25 pipes. Net height of pipe support: from 240 to 320 mm.

Code	For Outboards	UM	€
0521215	< 10 HP	PCS	

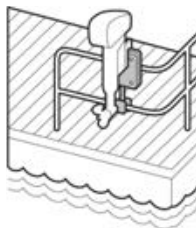

**Rail Mount PL Outboard Bracket**

Reinforced Plastic pad rail mount bracket for small outboards. Stainless Steel pipe support and screws. Pad dimensions: 195 x H215 mm. Net height of pipe support: 260 mm.

Code	For Outboards	UM	€
0521216	< 10 HP	PCS	

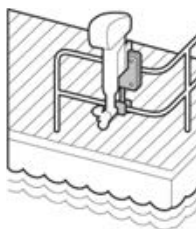

**Platform and Ladders Spare Connector**

Stainless Steel spare U clip connector for transom swim platforms and ladders.

Code	For Tube ø mm	UM	€
<b>0640622</b>	22	PCS	
<b>0640625</b>	25	PCS	



**90° Open T Joint**

Moulded Stainless Steel 90° open T connector.

Code	Ø mm	UM	€
<b>0638022</b>	22	PCS	
<b>0638025</b>	25	PCS	

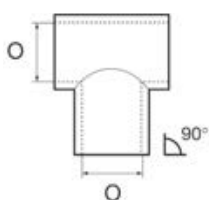

**Ladder Spare Removable Socket**

Stainless Steel removable socket for boarding ladders. The socket allows a quick ladder removal off the transom.

Code	For Tube ø mm	UM	€
<b>0643122</b>	22	PCS	
<b>0643125</b>	25	PCS	



**Platform and Ladders Connector**

Stainless Steel connector for transom swim platforms and ladders.

Code	For Tube ø mm	UM	€
<b>0640626</b>	25	PCS	



**Transom Platforms Swiveling Base**

Stainless Steel spare base for transom swim platforms.

Code	For Tube ø mm	Base ø mm	UM	€
<b>0637000</b>	25	70	PCS	



**Ladder Spare Connector**

Stainless Steel spare connector for folding ladders.

Code	For Tube ø mm	UM	€
<b>0643522</b>	22	PCS	
<b>0643525</b>	25	PCS	



**Platform and Ladder Spare Socket**

Stainless Steel spare socket for transom swim platforms and ladders.

Code	For Tube ø mm	UM	€
<b>0643022</b>	22	PCS	
<b>0643025</b>	25	PCS	



**Wide Lacing Strap**

Moulded Stainless Steel lacing straps.

Code	For Tube ø mm	UM	€
<b>0640522</b>	22	PCS	
<b>0640525</b>	25	PCS	



**Platform Plate Socket**

Stainless Steel platform plate socket.

Code	For Tube ø mm	UM	€
<b>0643029</b>	25	PCS	
<b>0643032</b>	32	PCS	



**Round Transom Platforms Base**

Stainless Steel base for transom swim platforms. It allows to adapt the platform to the transom.

Code	Base ø mm	UM	€
<b>0637002</b>	70	PCS	



**Flushed Sockets for Gangways**

Flush mount sockets for gangways with 25 mm pin.

Code	Material	UM	€
0607501	Lacquered Aluminum	PCS	
0607502	Chromed Brass	PCS	
0607503	Stainless Steel	PCS	



**Rocker Pin for Gangways**

Aluminum equalizer rocker pin for gangways. ø 30 mm

Code	H mm	H1 mm	UM	€
0607509	135	70	PCS	



**Gangways' Hinge**

Aluminum hinge for gangways.

Code	H mm	H1 mm	W mm	W1 mm	UM	€
0607514	115	80	38	18	PCS	

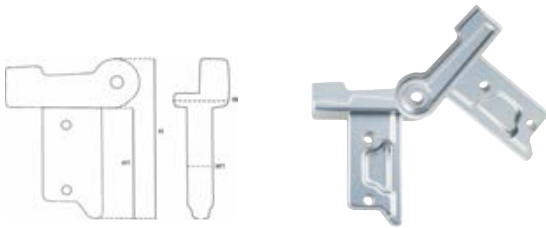

**Small Carrier Wheels**

Wheels for carriers and gangways.

Code	ø mm	Shaft ø mm	UM	€
2805060	80	10	PCS	



**Stanchion for Gangways**

Anodized Aluminum stanchion for gangways.

Code	ø mm	H mm	UM	€
0607507	25	700	PCS	



**Rocker Arm for Gangways**

Anodized Aluminum swivel mounting equalizer for gangways. M8 Screws.

Code	Pin mm	L mm	UM	€
0607508	ø25 x L73	330	PCS	



**Support Triangle for Gangways**

Stainless Steel construction supporting triangle. The 3 shackles allow a quick attach to the gangway and to the backstay.

Code	cm	UM	€
0607516	45	PCS	



**Gangways' Terminal**

Aluminum terminal for gangways.

Code	H mm	H1 mm	W mm	W1 mm	UM	€
0607510	150	80	28	18	PCS	



**Stanchion Base for Gangways**

Anodized Aluminum stanchion lateral base for gangways. ø 25 mm, H 65 mm.

Code	UM	€
0607506	PCS	



**Guardrail Set for Gangways**

Stainless Steel guardrail stanchion set.

Code	ø mm	UM	€
0606002	25	PCK	



**Carbon Gangway**

Very light and resistant Carbon fiber gangway. Complete with pin and flush mount socket. Floating, free from corrosion and UV rays alteration. With non-slip surface.

Code	Ref	Dim cm	Max Load Kg	Weight Kg	UM	€
<b>0607840</b>	Fix	200 x 38	200	7,5	PCS	
<b>0607842</b>	Foldable	220 x 38	200	8,6	PCS	



**Carbon Composite Gangway**

Strong and lightweight gangway made of Carbon fiber and Polymers composite. Built in single piece without bonding, complete with pin and flush mount socket. Floating, rust-proof and UV alteration free. With anti-slip surface and elastic protective side tape to avoid scratches.

Code	Ref	Dim cm	Max Load Kg	Weight Kg	UM	€
<b>0607876</b>	Carbon Fix	220 x 39	250	9,5	PCS	
<b>0607880</b>	Carbon Foldable	220 x 39	250	11,5	PCS	



**TPC Composite Gangway**

Strong and lightweight gangway built with innovative thermoplastic composite material. Ideal for tough and continuous use, perfect for charter and marinas. Built in single piece without bonding, floating, corrosion-free and UV-resistant. The surface is completely non-slip with rubber scratch-resistant edge and protections.

Code	Dim cm	Max Load Kg	Weight Kg	UM	€
<b>0607872</b>	220 x 40	250	8	PCS	
<b>0607874</b>	245 x 40	250	9	PCS	



**Aluminum Fixed Gangway**

Anodized Aluminum light duty fixed gangway with antislip walkway. Complete with check pin and wheels.

Code	Dim cm	Max Load Kg	UM	€
<b>0606018</b>	200 x 37	120	PCS	



**Aluminum Folding Gangway**

Anodized Aluminum light duty folding gangway with antislip walkway. Complete with check pin and wheels.

Code	Dim cm	Weight Kg	UM	€
0606518	200 x 37	9,75	PCS	
0606523	230 x 37	10,1	PCS	
0606526	260 x 37	12	PCS	



**Aluminum and Grating Folding Gangway**

Anodized Aluminum folding gangway with grating marine wood walkway. Complete with check pin and wheels.

Code	Dim cm	UM	€
0607518	190 x 37	PCS	
0607525	250 x 37	PCS	



**Aluminum and Grating 3-Fold Gangway**

Anodized Aluminium 3-folding gangway with grating marine wood walkway. Complete with check pin and wheels. Easy to stow, only 69 cm height when folded.

**New**

Code	Open Dim cm	Folded Dim cm	Capacity Kg	Weight Kg	UM	€
0607530	200 x 32	69 x 32	150	11,2	PCS	



**Stainless Steel and Grating Folding Gangway**

316 Stainless Steel frame folding gangway with grating Iroko wood walkway. Complete with ø 25 mm check pin and wheels.

Code	Open Dim cm	Folded Dim cm	Max Load Kg	Weight Kg	UM	€
0608521	200 x 32	110 X 32	150	14,6	PCS	
0608524	230 x 32	120 X 32	150	16,4	PCS	



**Thru Deck Davits Pair**

Polished Stainless Steel through deck mounting set of davits sold in pairs. The set includes guide bushings, base sockets, lines, pulleys, bollards, blocks and shackles. The part below the deck is longer in order to be cut as needed.

Code	Tubing ø mm	H cm	Capacity Kg	UM	€
0600012	40	180	120	PR	
0600016	60	180	170	PR	



**On Base Davits Pair**

Polished Stainless Steel tube base mount set of swiveling davits. Sold in pairs. Complete with pulleys, bollards and carabiners. Mounting hole not required.

Code	Tubing ø mm	Capacity Kg	UM	€
0600020	42	110	PR	

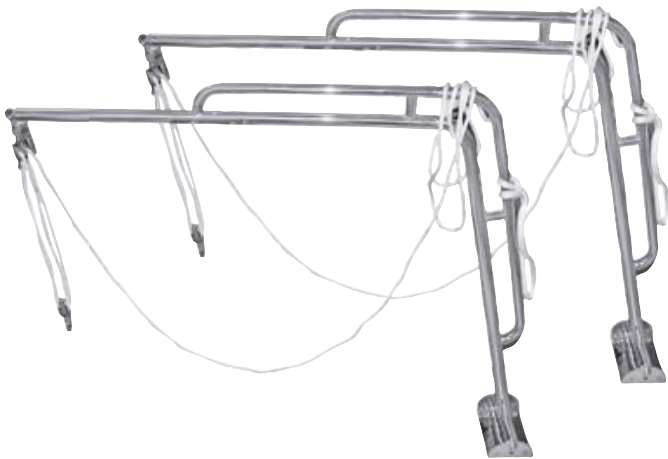

**Motor Lift Davit**

Polished Stainless Steel tender outboard lift davit. Fixed or removable mounting, can rotate on the pulpit. Complete with joints, pulley, bollard, block and shackle. Accessories: Polyester lift caddy for outboards up to 15 HP 2 and 4 stroke.

Code	Tubing ø mm	H cm	Capacity Kg	Accessories	UM	€
0601014	40	140	50		PCS	
0601024			50	Outboard Caddy	PCS	

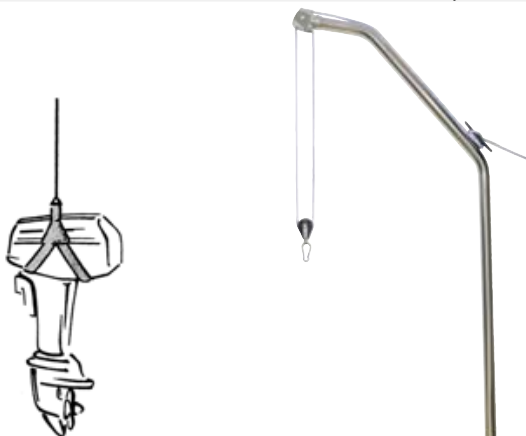

**On Deck Davits Pair**

Polished Stainless Steel on deck mount set of swiveling davits. Sold in pairs. The set includes base sockets, lines, pulleys, bollards, blocks and shackles.

Code	Tubing ø mm	H cm	Capacity Kg	UM	€
0600022	40	90	120	PR	
0600026	60	90	170	PR	



**Inflatables Lifting System**

Stern platform davits kit for lifting and pulling on board inflatables as tenders. With 2 Stainless Steel mount plates and 2 Rubber handle-plates to be fixed on the inflatable.

Code	UM	€
0600004	PCK	



**Motor Caddy Harness**

UV and marine environment resistant harness. Safe and easy to use thanks to the harness specifically designed for 2-4 stroke engines up to 15HP. 

Code	For Outboards	UM	€
0601030	Up to 15HP	PCS	



**Double Bar Standard Rollbar**

Mirror polished double bar Stainless Steel Rollbar.

Code	Tube ø mm	Width mm	H mm	UM	€
<b>0610013</b>	30	900<>2250	1200	PCS	
<b>0610014</b>	40	900<>2250	1450	PCS	



**Double Bar Shaped Rollbar**

Mirror polished double bar shaped Stainless Steel Rollbar. Ideal for mounting on inflatables thanks to the tubular shape.

Code	Tube ø mm	Width mm	H mm	UM	€
<b>0610023</b>	30	900<>2200	1150	PCS	
<b>0610024</b>	40	900<>2200	1400	PCS	



**T-Top**

Sturdy reinforced Aluminum structure T-Top.  
100% Polyester fabric PVC coated.

Code	Colour	W cm	L cm	H cm	UM	€
<b>0610064</b>	WHITE	141	172	205	PCS	
<b>0610065</b>	BLUE NAVY	141	172	205	PCS	

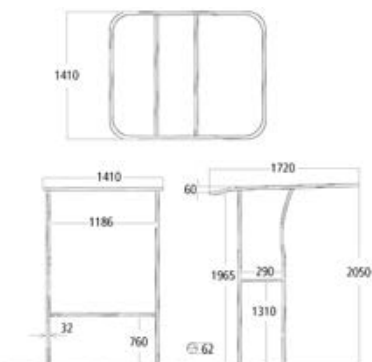



**Sail Bow - Bow Ambo**

Sailboats marine grade 316 Stainless Steel bow ambos.

Code	Rail ø mm	H mm	Width mm	Length mm	UM	€
<b>0611645</b>	22	450	800 (± 150)	900	PCS	
<b>0611660</b>	22	600	740 (± 150)	1100	PCS	



**Sail Stern - Stern Ambo**

Sailboats marine grade 316 Stainless Steel stern ambos. Composed with 2 parts, left and right.

Code	Rail ø mm	H mm	Back L mm	Side L mm	Corner	UM	€
<b>0611745</b>	22	450	350	400	100°	PCS	
<b>0611760</b>	22	600	400	430	100°	PCS	



**Open Bow Ambo with Sleeper**

Stainless Steel Open type bow ambos with crossbar. The bow opening helps people transit.

Code	Rail ø	H mm	Width mm	Length	Bar Length	UM	€
<b>0611804</b>	22 mm	450	400<>1400	1150 mm	250 mm	PCS	



**Stern Handrail**

Stern mount Stainless Steel handrail with lifeline eyelets.

Code	Rail ø mm	Height mm	Width mm	UM	€
<b>0611802</b>	25	610	325	PCS	



**Lifeline Netting H600 mm**

100% Polyester lifeline netting. H600 mm. Diamond welded the cheapest, square knotted the safest.

Code	Type	Package m	UM	€
<b>3215508</b>	Diamond Welded	20	PCK	
<b>3215509</b>	Diamond Welded	30	PCK	
<b>3215510</b>	Diamond Welded	50	PCK	
<b>3215512</b>	Square Knotted	20	PCK	
<b>3215511</b>	Square Knotted	30	PCK	
<b>3215513</b>	Square Knotted	50	PCK	



**Triangular Stanchion Bases**

Stainless Steel triangular stanchion bases. Base dimensions 95 x 95 x 77 mm.

Code	For Stanchions ø mm	Base	UM	€
<b>0612525</b>	25	Flat	PCS	
<b>0612625</b>	25	Angled 6°	PCS	

**Square Stanchion Bases**

Stainless Steel square stanchion bases. Base dimensions 91 x 64 mm.

Code	For Stanchions ø mm	Base	UM	€
<b>0612425</b>	25	Flat	PCS	
<b>0612426</b>	25	Angled 6°	PCS	

**Stainless Steel Stanchions**

Stainless Steel cone stanchions ø 25 mm.

Code	H mm	Holes	Wheelbase mm	UM	€
<b>0612045</b>	505	2	295	PCS	
<b>0612060</b>	610	2	300	PCS	
<b>0612075</b>	725	2	355	PCS	

**- HANDRAILS -****Rainbow Handrail**

Bow or stern mounting Stainless Steel handrail. Makes more safe boarding of people.

Code	Rail ø mm	Height mm	Width mm	UM	€
<b>0611800</b>	25	450	320	PCS	
<b>0611801</b>	25	600	480	PCS	

**Angled Handrail**

Bow or stern mount Stainless Steel high handrail. Makes more safe boarding of people.

Code	Rail ø mm	Height mm	Width mm	UM	€
<b>0611803</b>	25	585	480	PCS	



**Stainless Steel Stud 1 Handrails**

Mirror Polished 316 Stainless Steel grab rails. Threaded insert bases for easy thru deck mounting.

Code	Tube ø mm	L mm	H mm	Thread	UM	€
0618230	22	300	50	M8	PCS	
0618240	22	450	50	M8	PCS	
0618250	22	600	50	M8	PCS	

**Stainless Steel Oval Handrails**

Elegant and sturdy polished 316 Stainless Steel oval handrails. Threaded insert bases for an easy and safe under deck through mount.

Code	Tube ø mm	L mm	H mm	Thread	UM	€
0618113	25 x 19	300	50	M8	PCS	
0618114	25 x 19	400	50	M8	PCS	
0618115	25 x 19	450	50	M8	PCS	
0618116	25 x 19	600	50	M8	PCS	

**Stainless Steel Fast 1 Handrails**

Stainless Steel classic handrails with drilled bases for an easy surface mount. Total height 80 mm for all measures.

Code	Tube ø mm	L mm	UM	€
0618020	22	250	PCS	
0618030	22	300	PCS	
0618050	22	500	PCS	
0618065	22	650	PCS	
0618080	22	850	PCS	
0618010	22	1100	PCS	

**Stainless Steel Fast 2 Handrails**

Stainless Steel classic handrails with drilled bases for an easy surface mount.

Code	Tube ø mm	L mm	UM	€
0618102	25	230	PCS	
0618103	25	300	PCS	
0618104	25	400	PCS	

**Stainless Steel Screw Handles**

Mirror polished Stainless Steel handles.

Code	L mm	H mm	Mounting	UM	€
0340829	300	50	2 Through Screws	PCS	
0340830	300	50	2 x 8 mm Hidden Studs	PCS	

**Stainless Steel Grip Handle**

Mirror polished 316 Stainless Steel handles with ergonomic grip. 2 x M6 Through screw mounting.

Code	L mm	H mm	UM	€
0340850	170	32	PCS	

**Sydney Long Handles**

Reinforced core with soft PVC body long door handles. Flush mounting through screws, wheelbase 195 mm.

Code	L mm	H mm	Colour	UM	€
0340720	250	60	DARK GREY 7046	PCS	
0340721	250	60	LIGHT GREY 7035	PCS	
0340722	250	60	SAND 1013	PCS	



**Stainless Steel Classic Handrail Supports**

Cast and polished Stainless Steel oval base handrail supports.

Code	L mm	H mm	ø mm	Ref	UM	€
0621822	62	55	22	End	PCS	
0621922	62	55	22	Center	PCS	
0621825	62	55	25	End	PCS	
0621925	62	55	25	Center	PCS	



**Stainless Steel New Line Handrail Supports**

Cast and polished Stainless Steel rectangular base handrail supports.

Code	H mm	ø mm	Ref	UM	€
0621022	38	22	Left End	PCS	
0621122	38	22	Center	PCS	
0621222	38	22	Right End	PCS	
0621025	38	25	Left End	PCS	
0621125	38	25	Center	PCS	
0621225	38	25	Right End	PCS	



**Stainless Steel Cilindric Handrail Supports**

Cast and polished Stainless Steel solid (non stamped) cylindrical base handrail supports. Complete with M8 thread.

Code	W mm	H mm	ø mm	Ref	UM	€
0623022	30	60	22	End	PCS	
0623122	30	60	22	Center	PCS	
0623025	35	65	25	End	PCS	
0623125	35	65	25	Center	PCS	

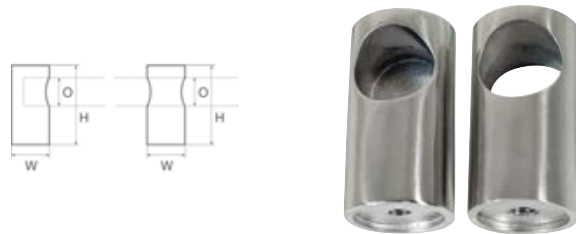

**Stainless Steel Shaped Handrail Supports**

Cast and polished Stainless Steel shaped handrail supports.

Code	H mm	ø mm	Ref	UM	€
0622822	38	22	End	PCS	
0622922	38	22	Center	PCS	
0622825	38	25	End	PCS	
0622925	38	25	Center	PCS	

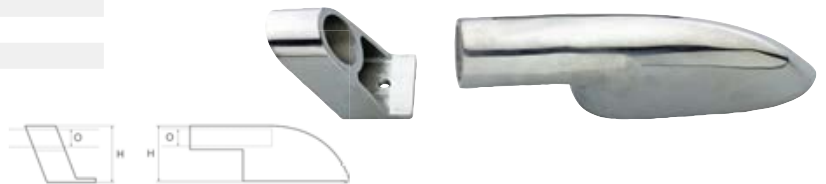

**Chromed Brass Classic Handrail Supports**

Chromed Brass round base handrail supports.

Code	W mm	H mm	ø mm	Ref	UM	€
0621026	50	62	25	End	PCS	
0621126	50	62	25	Center	PCS	
0621030	65	75	30	End	PCS	
0621130	65	75	30	Center	PCS	
0621035	70	90	35	End	PCS	
0621135	70	90	35	Center	PCS	



**Mirror Polished 316 Stainless Steel Rail Pipes**

Mirror polished 316 Stainless Steel rail tubing.

Code	ø mm	Thickness mm	Rail m	UM	€
061902202	22	1,2	2	PCS	
061902203	22	1,2	3	PCS	
061902602	25	1,5	2	PCS	
061902603	25	1,5	3	PCS	
061903002	30	1,5	2	PCS	
061903003	30	1,5	3	PCS	



**60° Round Weld Base**

Moulded Stainless Steel 60° round soldering base.

Code	O mm	UM	€
<b>0636022</b>	22	PCS	
<b>0636025</b>	25	PCS	



**90° Round Weld Base**

Moulded Stainless Steel 90° round soldering base.

Code	O mm	UM	€
<b>0636222</b>	22	PCS	
<b>0636225</b>	25	PCS	



**60° Round Base**

Moulded Stainless Steel 60° round base.

Code	O mm	UM	€
<b>0631022</b>	22	PCS	
<b>0631025</b>	25	PCS	

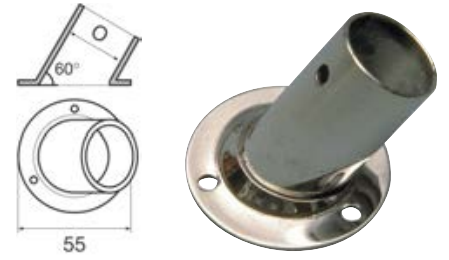

**60° Rectangular Weld Base**

Moulded Stainless Steel 60° rectangular soldering base.

Code	O mm	UM	€
<b>0637022</b>	22	PCS	
<b>0637025</b>	25	PCS	

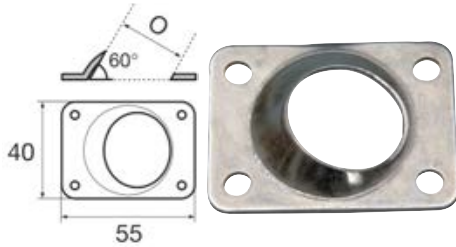

**90° Rectangular Weld Base**

Moulded Stainless Steel 90° rectangular soldering base.

Code	O mm	UM	€
<b>0637222</b>	22	PCS	
<b>0637225</b>	25	PCS	

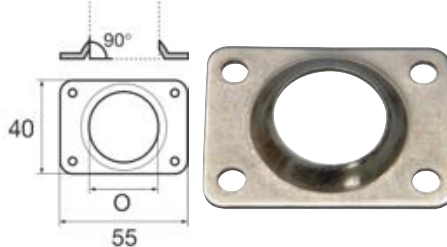

**90° Round Base**

Moulded Stainless Steel 90° round base.

Code	O mm	UM	€
<b>0631522</b>	22	PCS	
<b>0631525</b>	25	PCS	

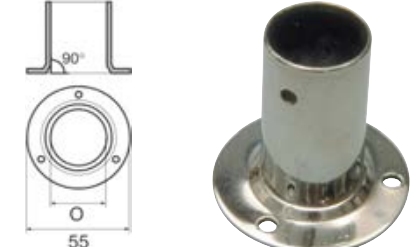

**60° Square Base**

Moulded Stainless Steel 60° square base.

Code	O mm	UM	€
<b>0631122</b>	22	PCS	
<b>0631125</b>	25	PCS	

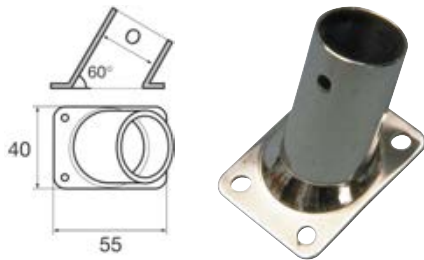

**90° Square Base**

Moulded Stainless Steel 90° square base.

Code	O mm	UM	€
<b>0631622</b>	22	PCS	
<b>0631625</b>	25	PCS	

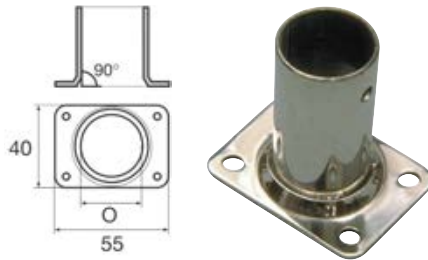

**60° T Joint**

Moulded Stainless Steel 60° T connector.

Code	O mm	Direction	UM	€
<b>0634322</b>	22	Left	PCS	
<b>0634323</b>	22	Right	PCS	
<b>0634326</b>	25	Left	PCS	
<b>0634325</b>	25	Right	PCS	

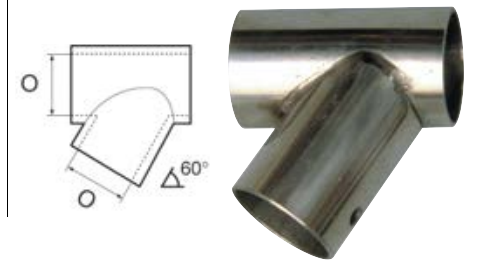

**90° T Joint**

Moulded Stainless Steel 90° T connector.

Code	O mm	UM	€
<b>0634022</b>	22	PCS	
<b>0634025</b>	25	PCS	

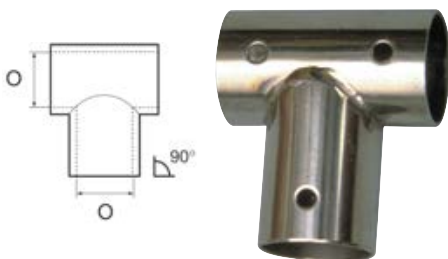

**60° Open T Joint**

Moulded Stainless Steel 60° open T connector.

Code	O mm	UM	€
<b>0638122</b>	22	PCS	
<b>0638125</b>	25	PCS	

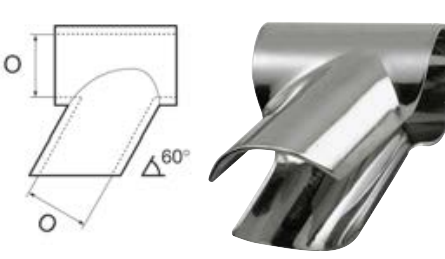

**90° Open T Joint**

Moulded Stainless Steel 90° open T connector.

Code	O mm	UM	€
<b>0638022</b>	22	PCS	
<b>0638025</b>	25	PCS	

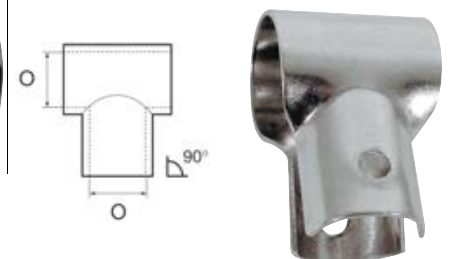

**60° Round Base**

Cast and polished 316 Stainless Steel 60° round base.

Code	O mm	D mm	UM	€
<b>0630122</b>	22	65	PCS	
<b>0630125</b>	25	71	PCS	



**90° Round Base**

Cast and polished 316 Stainless Steel 90° round base.

Code	O mm	D mm	UM	€
<b>0630622</b>	22	65	PCS	
<b>0630625</b>	25	71	PCS	



**60° T Joint**

Cast and polished 316 Stainless Steel 60° T connector.

Code	O mm	UM	€
<b>0633822</b>	22	PCS	
<b>0633825</b>	25	PCS	

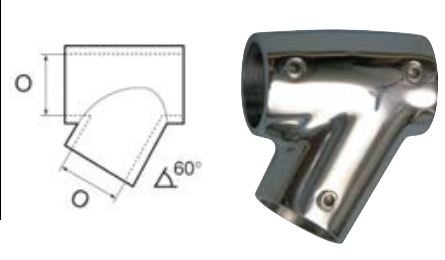

**60° Square Base**

Cast and polished 316 Stainless Steel 60° square base.

Code	O mm	UM	€
<b>0630322</b>	22	PCS	
<b>0630325</b>	25	PCS	



**90° Square Base**

Cast and polished 316 Stainless Steel 90° square base.

Code	O mm	UM	€
<b>0630722</b>	22	PCS	
<b>0630725</b>	25	PCS	



**90° T Joint**

Cast and polished 316 Stainless Steel 90° T connector.

Code	O mm	UM	€
<b>0633522</b>	22	PCS	
<b>0633525</b>	25	PCS	

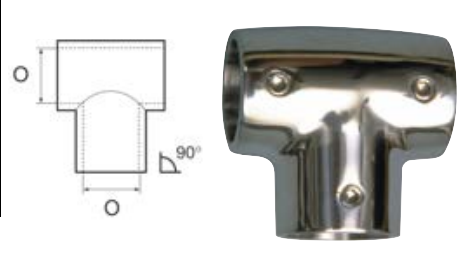

**60° Open T Joint**

Cast and polished 316 Stainless Steel 60° open T connector.

Code	O mm	UM	€
<b>0633622</b>	22	PCS	
<b>0633625</b>	25	PCS	

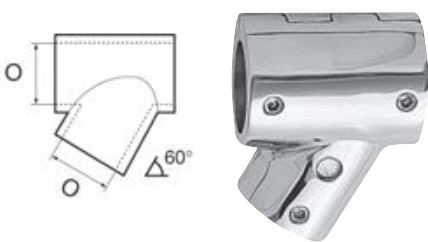

**90° Open T Joint**

Cast and polished 316 Stainless Steel 90° open T connector.

Code	O mm	UM	€
<b>0633632</b>	22	PCS	
<b>0633635</b>	25	PCS	

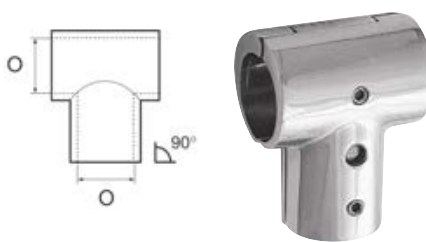

**Elbow Joint**

Cast and polished 316 Stainless Steel 90° elbow connector.

Code	O mm	UM	€
<b>0633922</b>	22	PCS	
<b>0633925</b>	25	PCS	



**110° Joint**

Cast and polished 316 Stainless Steel 110° connector.

Code	O mm	UM	€
<b>0633931</b>	22	PCS	
<b>0633933</b>	25	PCS	



**140° Joint**

Cast and polished 316 Stainless Steel 140° connector.

Code	O mm	UM	€
<b>0633932</b>	22	PCS	
<b>0633935</b>	25	PCS	



**3-Way Joint**

Cast and polished 316 Stainless Steel 3-Way connector.

Code	O mm	UM	€
<b>0634522</b>	22	PCS	
<b>0634525</b>	25	PCS	

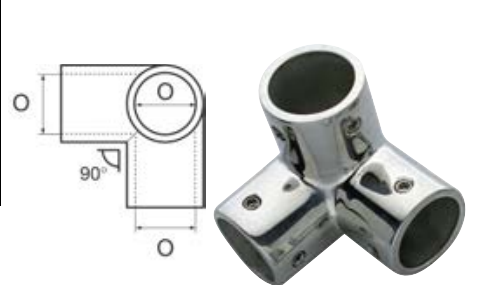

**Plastic Flag Staff**

Plastic flag staff with side and vertical base for surface or wall mounting. Available also a suction cap base as an optional for inflatables.

Code	H mm	Accessories	UM	€
<b>0810063</b>	300		PCS	
<b>0810064</b>	400		PCS	
<b>0810267</b>		Suction Cap Base	PCS	



**Gummy N Flag Staff**

Black Nylon flag staff with PVC base to be purchased separately. For inflatables. Base 80 x 80 mm.

Code	Ref	H mm	UM	€
<b>0810072</b>	Staff	265	PCS	
<b>0810272</b>	Base		PCS	



**Gummy G Flat Flag Staff**

Inclined Grey Plastic flag staff with rubber base to be purchased separately. For inflatables.

Code	Ref	H mm	UM	€
<b>0810069</b>	Staff	300	PCS	
<b>0810269</b>	Base		PCS	



**Compact Chrome Flag Staff**

Chromed Brass compact flag staff with removable snap base and rod. Complete with 2 rope eyelets.

Code	H mm	ø mm	UM	€
<b>0810003</b>	350	13	PCS	
<b>0810005</b>	500	13	PCS	



**Clamp Chromed Brass Flag Staff**

Chromed Brass flag staff with Clamp-on socket for tubing ø 20<>25 mm.

Code	H mm	ø mm	UM	€
<b>0810013</b>	350	13	PCS	
<b>0810015</b>	500	13	PCS	



**Clamp Stainless Steel Flag Staff**

Stainless Steel flag staff with clamp-on socket for tubing ø 22<>25 mm.

Code	H mm	UM	€
<b>0810023</b>	380	PCS	



**Classic Stainless Steel Flag Staff**

Stainless Steel classic flag staff with 2 rope eyelets. Comes complete with base and screw latch.

Code	H mm	ø mm	UM	€
<b>0810036</b>	600	20	PCS	
<b>0810038</b>	800	25	PCS	



**Folding Stainless Steel Flag Staff**

Stainless Steel folding pole flag staff with adjustment knob.

Code	H mm	ø mm	UM	€
<b>0810026</b>	660	25	PCS	

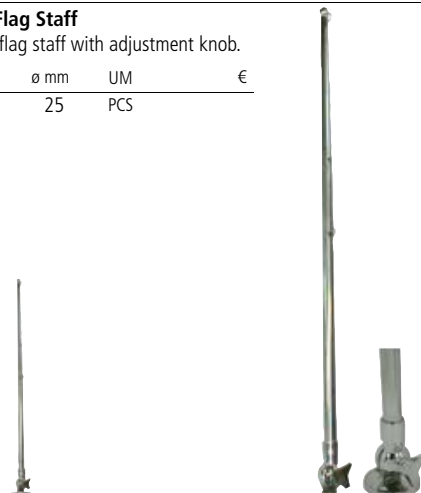

**Classic White Cap Stainless Steel Flag Staff**

Classic Stainless Steel flag staff with 2 rope eyelets. To be completed with surface mount standard socket.

Code	H mm	ø mm	Accessories	UM	€
0810081	400	14		PCS	
0810082	600	20		PCS	
0810083	800	25		PCS	
0810074			ø 14 mm Socket	PCS	
0810075			ø 20 mm Socket	PCS	
0810076			ø 25 mm Socket	PCS	



**Classic Yacht Stainless Steel Flag Staff**

Classic Stainless Steel flag staff with 2 rope eyelets. To be completed with standard or flush socket.

Code	H mm	ø mm	Accessories	UM	€
0810086	600	20		PCS	
0810087	750	25		PCS	
0810088	900	25		PCS	
0810089	1200	25		PCS	
0810078			ø 20 mm Flush Socket	PCS	
0810079			ø 25 mm Flush Socket	PCS	
0810075			ø 20 mm Standard Socket	PCS	
0810076			ø 25 mm Standard Socket	PCS	



**Lahna Pine Flag Staff**

Tough clear Finnish Pine flag staff with Mahogany cap and rope cleat. Perfect finishing with special water-repellent protective varnish.

Code	H mm	ø mm	UM	€
0810166	600	25	PCS	
0810168	750	25	PCS	
0810169	1000	25	PCS	
0810171	1250	25	PCS	
0810173	1500	25	PCS	



**Lahna Mahogany Flag Staff**

Elegant Mahogany flag staff with cap and rope cleat. Perfect finishing with special water-repellent protective varnish.

Code	H mm	ø mm	UM	€
0810156	650	25	PCS	
0810158	800	25	PCS	
0810160	1000	25	PCS	



**Flag Staff Stainless Steel Sockets**

Stainless Steel flag staffs' sockets. Standard or flush mount.

Code	Flag Staff ø mm	Ref	UM	€
0810057	25	Standard	PCS	
0810058	25	Flush Mount	PCS	



**Flag Staff Brass Sockets**

Brass flag staffs' sockets, screw latch included.

Code	Flag Staff ø mm	Ref	UM	€
0810055	25	CHROMED	PCS	
0810056	25	POLISHED	PCS	



**Flag Staff Clamp Socket**

Stainless Steel body clamp-on pole socket for 22<>25 mm tubing.

Code	Flag Staff ø mm	Clamp mm	UM	€
0810059	25	22<>25	PCS	



**Flag Staff Swivel Clamp Socket**

Stainless Steel body with swivelling clamp-on pole socket for 22<>25 mm tubing.

Code	Flag Staff ø mm	Clamp mm	UM	€
0810060	25	22<>25	PCS	





**Telescopic Easy Boathook**

Anodized Aluminum pole and Plastic hook tip telescoping boathook. Two ergonomic handles for a comfortable and secure grip.

Code	L cm	UM	€
0700510	60<>100	PCS	
0700521	120<>200	PCS	



**Telescopic Easy Color Boathook**

Anodized Aluminum pole and Plastic hook tip telescoping boathook. Two ergonomic handles for a comfortable and secure grip. Bright lacquered colours for a long lasting life.

Code	L cm	Ref	UM	€
0701520	120<>200	WHITE	PCS	
0701521	120<>200	RED	PCS	
0701522	120<>200	BLUE	PCS	

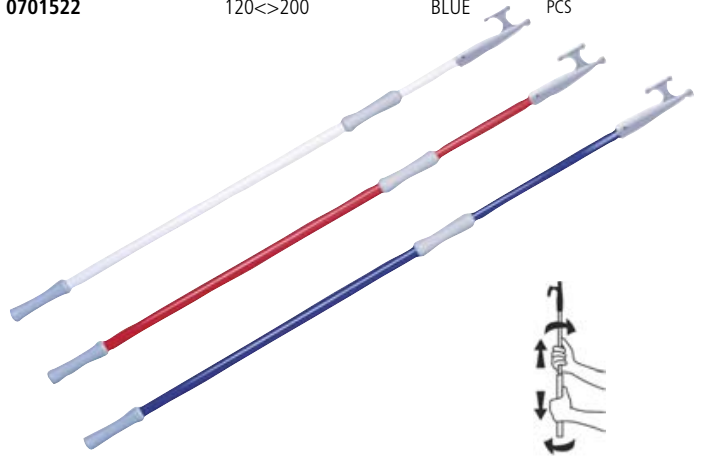

**Lock Telescoping Boat Hook**

Reinforced Anodized Aluminum telescoping boat hook with multi position lock system and reinforced Plastic hook.

Code	L cm	UM	€
0700522	130<>220	PCS	



**Bi-Telescoping Boat Hook**

Anodized Aluminum bi-telescoping boat hook with reinforced Plastic hook. Ergonomic handle for a comfortable and secure grip.

Code	L cm	UM	€
0700524	110<>250	PCS	



**Wood Fixed Boathook**

Wooden pole and Stainless Steel boathook tip. Comfortable and secure grip handle onto the Wooden pole.

Code	L cm	UM	€
0700618	180	PCS	
0700621	210	PCS	
0700625	250	PCS	



**Alu Fixed Boathook**

Anodized Aluminum pole and Plastic boathook tip. Ergonomic handle for a comfortable and secure grip.

Code	L cm	UM	€
0700515	150	PCS	
0700518	180	PCS	



**Plastic Boathook Tip**

Plastic boathook tip.

Code	ø mm	UM	€
<b>0702925</b>	25	PCS	
<b>0702930</b>	30	PCS	
<b>0702935</b>	35	PCS	

**Brass Boathook Tip**

Chromed Brass boathook tip.

Code	ø mm	UM	€
<b>0703000</b>	28	PCS	
<b>0703001</b>	35	PCS	

**Brass Double Boathook Tip**

Chromed Brass twin boathook tip.

Code	ø mm	UM	€
<b>0703002</b>	35	PCS	

**Plastic Boathook for Paddles**

Plastic boathook for paddles.

Code	For Pole ø mm	UM	€
<b>0713025</b>	25	PCS	
<b>0713030</b>	30	PCS	

**Blades for Oars and Paddles**

Plastic spare blades for oars and paddles.

Code	ø mm	cm	UM	€
<b>0716048</b>	30	50 x 17	PCS	
<b>0716050</b>	35	50 x 17	PCS	

**PVC Plastic Grip for Paddles and Boathooks**

PVC grip for paddles and boathooks.

Code	For Pole ø mm	UM	€
<b>0702825</b>	25	PCS	
<b>0702830</b>	30	PCS	

**PVC Plastic Handle for Oars and Paddles**

PVC Handle for oars and paddles.

Code	For Pole ø mm	UM	€
<b>0711590</b>	35	PCS	



**Aluminum Paddle**

Anodized Aluminum shaft and Plastic blade paddle.

Code	ø mm	L cm	Boathook	UM	€
0701400	30	140	Yes	PCS	
0701401	30	140	No	PCS	



**Aluminum Disassembling Paddle**

Anodized Aluminum shaft and Plastic blade disassembling paddle.

Code	ø mm	L cm	UM	€
0701402	35	71/142	PCS	



**Aluminum Telescopic Paddle with Boathook**

Anodized Aluminum shaft and Plastic blade telescopic paddle with boathook.

Code	ø mm	L cm	UM	€
0701413	30	100<>130	PCS	
0701420	30	120<>165	PCS	



**Aluminum Tritelescopical Paddle with Boathook**

Anodized Aluminum shaft and Plastic blade tritelescopical paddle with boathook.

Code	ø mm	L cm	UM	€
0701110	28-25	55<>110	PCS	



**Jobe Disassembling Paddle**

Jobe disassembling paddle ideal for Sup and water sports pleasurecrafts. Light and resistant with reinforced Plastic blades and T-grip handle made of Anodized Aluminum or Carbon mixed to Fiberglass.



Code	L cm	Handle	UM	€
0701210	170/210	Anodized Aluminum	PCS	
0701211	170/210	Fiberglass and Carbon	PCS	



**Kajak Disassembling Paddle**

Disassembling Anodized Aluminum kayak paddle with reinforced Plastic blades.

Code	L cm	UM	€
0701224	220	PCS	



**Light Aluminum Oar**

Anodized Aluminum shaft and Plastic blade oar.

Code	ø mm	L cm	UM	€
0701019	35	185	PCS	
0701021	35	210	PCS	



**Aluminum Disassembling Oar**

Anodized Aluminum shaft and Plastic blade disassembling oar.

Code	ø mm	L cm	UM	€
0701216	35	82/165	PCS	
0701220	35	101/202	PCS	



**Lahna SeaGrade Oars**

High quality, lightweight and resistant oars, the best for harsh sea conditions. Ergonomic grip, balanced blade, Polyurethane varnish finishing. Complete with oarlock sleeve. Sold in pairs.

Code	L cm	ø mm	UM	€
0700018	180	44	PR	
0700020	200	44	PR	
0700022	220	44	PR	
0700024	240	44	PR	
0700026	260	44	PR	
0700030	300	47	PR	



**Lahna SeaModule Oars**

Superior quality lightweight construction oars with reinforced Plastic disassembling blade. With resistant handle for harsh sea conditions, ergonomic grip and Polyurethane varnish finishing. Sold in pairs.

Code	L cm	ø mm	UM	€
0700010	180	44	PR	
0700011	210	44	PR	
0700012	240	44	PR	



**Disassembling Lahna SeaGrade Oars**

Lightweight and resistant disassembling oars, the best for harsh sea conditions. Shaped handle, blade tip reinforced with a wedge, finished with Polyurethane varnish. Sold in pairs.

Code	L cm	ø mm	UM	€
0700217	165	35	PR	
0700220	195	35	PR	
0700222	210	35	PR	



**Lahna Rescue Oar**

Lightweight, balanced and resistant oar, the best for harsh sea conditions, obtained from a single piece of wood. Shaped handle and Polyurethane varnish finishing. Ideal for rescue vessels or big boats.

Code	L cm	ø mm	UM	€
0700059	390	60	PCS	
0700062	420	60	PCS	



**Lahna Inditour Paddle**

Clear Finnish Timber laminated paddle. The best for harsh sea conditions. Shaped handle, blade tip reinforced with a wedge. Finished with weather-proof polyurethane varnish. Suitable both for canoes and boats.

Code	L cm	Weight Kg	UM	€
0700212	125	0,62	PCS	
0700214	140	0,75	PCS	



**Lahna IndiWinner Paddle**

A high quality light paddle made of Aspen and Alder. The shaped handle and the blade tip reinforced with a wedge provide a good balance and excellent paddling properties. Finished with special weather-proof polyurethane varnish. Suitable both for canoes and boats.

Code	L cm	Weight Kg	UM	€
0700232	125	0,57	PCS	
0700234	140	0,72	PCS	



**Oarlock Sleeves**

Plastic oarlock sleeves.

Code	For Oar ø mm	UM	€
0711535	35	PCS	
0711540	40	PCS	
0711545	45	PCS	
0711550	50	PCS	

**Chromed Brass Oarlock**

Casted Chromed Brass oarlocks. Bright chrome plating.

Code	Oar ø mm	Shank ø mm	Socket	UM	€
0706048	48	12		PCS	
0706058	58	14		PCS	
0706068	68	14		PCS	
0706212			Flush Mount ø 12	PCS	
0706214			Flush Mount ø 14	PCS	

**Plastic Oarlock**

Reinforced Plastic oarlocks. ø 17 mm mount.

Code	Oar ø mm	Socket	UM	€
0706550	50		PCS	
0706555	56		PCS	
0706720		Flush Mount	PCS	
0706725		Side Mount	PCS	

**Eco Clamp Oarlock**

Plastic clamp-on oarlock for Ø 35 mm oars. Plastic bayonet mount for inflatable and tender oarlock holders.

Code	Colour	UM	€
0706636	GREY	PCS	
0706637	BLACK	PCS	

**Extra Clamp Oarlock**

Plastic clamp-on oarlock for Ø 35 mm oars. Brass bayonet mount for inflatable and tender oarlock holders.

Code	Colour	UM	€
0706646	GREY	PCS	
0706647	BLACK	PCS	

**Lahna Rowlock Oarlock**

A practical and strong Plastic rowlock. The oar is placed into the plastic coupling ring, where the oar stays in place even if you release the grip. It ensures an easy and safe rowing.

Code	For Oar ø	Shank ø	Socket	UM	€
0706643	44 mm	17 mm		PCS	
0706717			Flush Mount	PCS	
0706718			Side Mount	PCS	



**Compact B Clip**

20 pieces compact Black clips per pack.

Code	Clip Range ø mm	UM	€
0712023	17/23	PCS	
0712028	22/28	PCS	
0712035	27/35	PCS	
0712045	34/45	PCS	



**Standard B Clip**

10 pieces standard Black clips per pack.

Code	Clip Range ø mm	UM	€
0712315	15	PCS	
0712320	20	PCS	
0712325	25	PCS	
0712330	30	PCS	
0712335	35	PCS	
0712340	40	PCS	
0712345	45	PCS	



**Double Clip**

10 pieces double clips per pack.

Code	Clip Range ø mm	UM	€
0712825	18/25	PCS	



**Stainless Steel Clip**

Stainless Steel extra strong clips. Sold in pairs.

Code	Clip Range ø mm	UM	€
0712831	22/28	PR	
0712832	30/40	PR	

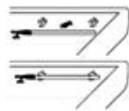

**Wall Mount HD Clip**

Two side mount soft clips featuring clipping size ø 22->35 mm. Sold in pairs.

Code	H mm	W mm	UM	€
0712834	80	60	PR	



**Compact W Clip**

20 pieces compact White clips per pack.

Code	Clip Range ø mm	UM	€
0712223	17/23	PCS	
0712228	22/28	PCS	
0712235	27/35	PCS	
0712245	34/45	PCS	



**Standard W Clip**

10 pieces standard White clips per pack.

Code	Clip Range ø mm	UM	€
0712415	15	PCS	
0712420	20	PCS	
0712425	25	PCS	
0712430	30	PCS	
0712435	35	PCS	
0712440	40	PCS	
0712445	45	PCS	



**Tenax Clip**

10 pieces large capacity Tenax clips per pack.

Code	Clip Range ø mm	UM	€
0712540	25/35	PCS	
0712542	35/50	PCS	



**Ladder Clip**

Folding ladder clips. Can be easily mounted on fixed part, allowing fast clipping of the folded side.

Code	Clip Range ø mm	UM	€
0712827	22/22	PCS	
0712828	25/25	PCS	



**Rail Mount HD Clips**

Two ø 22->25 mm rail mount soft clips featuring clipping size ø 22->35 mm. Sold in pairs.

Code	H mm	W mm	UM	€
0712835	80	60	PR	



**Ceiling Mount Rest Rod Holder**

Ceiling/wall rod rack for rods, boathooks etc.

Code	UM	€
<b>0800099</b>	PCS	

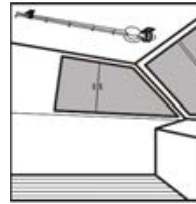
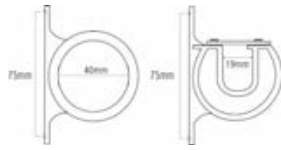

**Wall Mount Rest Rod Holder**

Wall mount rod racks for rods, boathooks etc.

Code	H mm	W mm	Slots	UM	€
<b>0800093</b>	216	73	2	PR	
<b>0800095</b>	381	73	4	PR	



**PSS Rod Holder**

Plastic body and Stainless Steel clamps wall mount rod holder.

Code	H mm	Internal ø mm	UM	€
<b>0800079</b>	225	40	PCS	

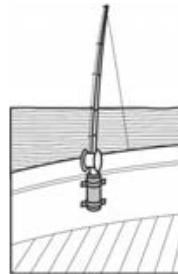

**SS Stainless Steel Rod Holder**

Stainless Steel wall mount rod holder.

Code	H mm	Internal ø mm	UM	€
<b>0800070</b>	300	40	PCS	

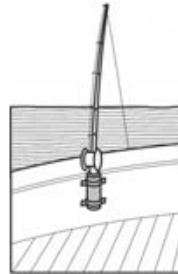

**PLS Rod Holder**

Multi-place Plastic rod holders with reinforced support. Wall mount.

Code	H mm	Internal ø mm	Slots	UM	€
<b>0800090</b>	285	40	3	PCS	
<b>0800091</b>	285	40	4	PCS	

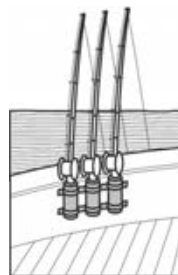

**S/Steel Multi-Place Rod Holders**

Stainless Steel mirror polished multi-place rod holders. Wall mount. Height 250 mm.

Code	L mm	Internal ø mm	Slots	UM	€
<b>0800072</b>	280	40	2	PCS	
<b>0800073</b>	350	40	3	PCS	

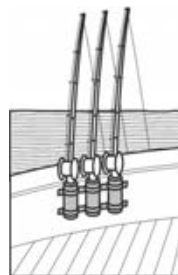

**Stainless Steel Angled Flush Rod Holder**

Flush mount Stainless Steel angled rod holder.

Code	H mm	Internal ø mm	UM	€
<b>0800010</b>	240	40	PCS	



**Stainless Steel Straight Flush Rod Holder**

Flush mount Stainless Steel straight rod holder.

Code	H mm	Internal ø mm	UM	€
<b>0800012</b>	230	50	PCS	



**PL/SS Flush Rod Holder**

Polished 316 Stainless Steel frame flush mount Plastic body rod holder.

Code	H mm	Internal ø mm	Colour	UM	€
<b>0800001</b>	240	40	BLACK	PCS	
<b>0800002</b>	240	40	WHITE	PCS	



**PLS Flush Rod Holder**

Flush mount Plastic body rod holder. Black and White PVC caps can be used for all rod holders.

Code	H mm	Internal ø mm	Colour	Accessories	UM	€
<b>0800084</b>	250	40	BLACK		PCS	
<b>0800085</b>	250	40	WHITE		PCS	
<b>0800184</b>				BLACK Cap	PCS	
<b>0800185</b>				WHITE Cap	PCS	



**PLSP Flush Rod Holder**

Plastic flush mount rod holder, used also for rod rest.

Code	H mm	Internal ø mm	Colour	UM	€
<b>0800086</b>	230	40	BLACK	PCS	
<b>0800087</b>	230	40	WHITE	PCS	



**Removable Rod Holder**

Removable side mount Stainless Steel rod holder. Bracket base: 110 x 110 mm.

Code	H mm	Internal ø mm	UM	€
<b>0800020</b>	350	40	PCS	





**Adjustable Stainless Steel Rod Holder**

Stainless Steel adjustable rod holder with plane base.

Code	Base mm	H mm	Internal ø mm	UM	€
<b>0800033</b>	93 x 63	370	40	PCS	



**Stainless Steel Adjustable Cover Rod Holder**

Stainless Steel adjustable rod holder with rubber bushing and plane base.

Code	Internal ø mm	UM	€
<b>0800034</b>	40	PCS	



**Adjustable Chromed Rod Holder**

Chromed Brass adjustable rod holder with base with rubber bushing to protect the rod handle.

Code	Base mm	H mm	Internal ø	Spare	UM	€
<b>0800030</b>	100 x 65	300	33 mm		PCS	
<b>0800031</b>	100 x 65	350	40 mm		PCS	
<b>0800130</b>				ø 33 Bushing	PCS	
<b>0800131</b>				ø 40 Bushing	PCS	



**Adjustable Double Swivel Chromed Rod Holder**

Chromed Brass adjustable rod holder with double swivel base and rubber bushing to protect the rod handle.

Code	Base mm	H mm	Internal ø	Spare	UM	€
<b>0800060</b>	93 x 63	400	40 mm		PCS	
<b>0800131</b>				Bushing	PCS	



**2 Mount WH Adjustable Rod Holder**

Reinforced Nylon body adjustable rod holder. Can be base mount or rail mount.

Code	L mm	Internal ø mm	UM	€
<b>0800082</b>	250	45	PCS	



**2 Mount BL Adjustable Rod Holder**

Reinforced Nylon body adjustable rod holder. Can be base mount or rail mount.

Code	L mm	Internal ø mm	UM	€
<b>0800083</b>	250	45	PCS	



**Adjustable Rail Clamp Stainless Steel Rod Holder**

Stainless Steel adjustable rod holder with rail clamp.

Code	For Rails ø mm	H mm	Internal ø	UM	€
<b>0800043</b>	22<>30	250	40 mm	PCS	



**TRUMP Stainless Steel Rod Holder with Clamp**

Adjustable Stainless Steel rod holder with PVC protection tube clamp. Internal wear-resistant Nylon lining.

Code	For Rails ø mm	H mm	Internal ø mm	UM	€
<b>0800044</b>	22<>25	265	42	PCS	
<b>0800045</b>	25<>32	265	42	PCS	
<b>0800046</b>	38<>50	265	42	PCS	



**Adjustable Clamp Double Swivel Rod Holder**

Chromed Brass adjustable rod holder with double swivel clamp and rubber bushing to protect the rod handle.

Code	Clamp Range	H mm	Internal ø	Spare	UM	€
<b>0800065</b>	100 mm	400	40 mm		PCS	
<b>0800131</b>				Rubber Bushing	PCS	

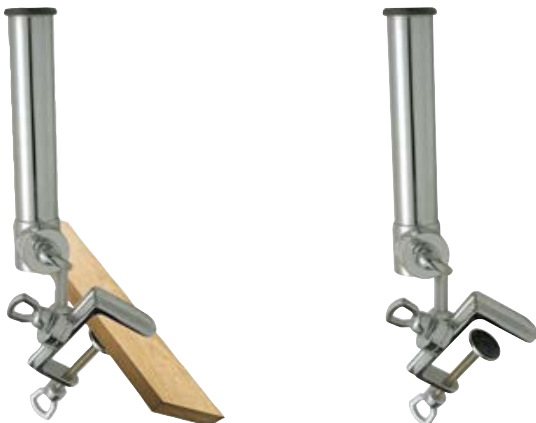

**Adjustable Rail Clamp Chromed Rod Holder**

Chromed Brass adjustable rod holder with rail clamp and rubber bushing to protect the rod handle.

Code	For Rails ø mm	H mm	Internal ø	Spare	UM	€
<b>0800040</b>	22<>28	250	40 mm		PCS	
<b>0800131</b>				Rubber Bushing	PCS	



**Adjustable Clamp Chromed Rod Holder**

Chromed Brass adjustable rod holder with clamp and rubber bushing to protect the rod handle.

Code	Clamp Range	H mm	Internal ø	Spare	UM	€
<b>0800050</b>	100 mm	400	40 mm		PCS	
<b>0800131</b>				Rubber Bushing	PCS	

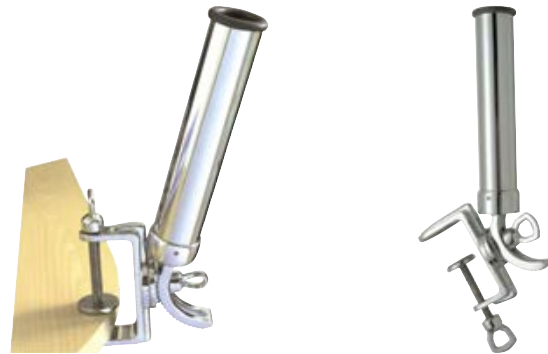

**Fishing Seat Rod Holder**

Chromed Brass fishing seat gimbal rod holder.

Code	For Rails ø mm	UM	€
<b>0847804</b>	22<>25	PCS	



**Sandra Seat**

Fold down upholstered seat. Marine grade Sky covering.

Code	W mm	L mm	H mm	UM	€
<b>0850041</b>	400	400	470	PCS	
<b>0850046</b>	400	400	530	PCS	

**Classic Seat**

Fold down upholstered seat. Marine grade Sky covering.

Code	W mm	L mm	H mm	Colour	UM	€
<b>0851000</b>	360	406	546	WHITE	PCS	
<b>0851002</b>	360	406	546	CREAM	PCS	
<b>0851004</b>	360	406	546	GREY	PCS	

**Fisherman Seat**

Fold down seat with Marine grade Sky removable cushions. Ergonomic and comfortable design, ideal for long fishing trips.

Code	W mm	L mm	H mm	Colour	UM	€
<b>0851010</b>	419	457	495	WHITE	PCS	
<b>0851012</b>	419	457	495	BLUE	PCS	
<b>0851014</b>	419	457	495	DARK GREY	PCS	

**Premium Soft Seat**

Fold down upholstered seat. Resistant marine grade Sky covering. Reinforced plastic body and corrosion-resistant Aluminum hinges. Comfortable design and soft padded seat.

Code	W mm	L mm	H mm	Colour	UM	€
<b>0851020</b>	457	482	603	BLUE	PCS	
<b>0851022</b>	457	482	603	DARK GREY	PCS	
<b>0851024</b>	457	482	603	RED	PCS	

**Premium Fishing Seat**

Fold down upholstered seat. Resistant marine grade Sky covering. Reinforced plastic body and corrosion-resistant Aluminum hinges. Comfortable design seat.

Code	W mm	L mm	H mm	Colour	UM	€
<b>0851030</b>	432	508	597	WHITE / DARK GREY	PCS	
<b>0851034</b>	432	508	597	GREY / DARK GREY	PCS	
<b>0851032</b>	432	508	597	GREY / BLUE	PCS	



**2 Place Marino Seat**

Fold down 2 place upholstered seat. Marine grade Skay covering.

Code	W mm	L mm	H mm	UM	€
<b>0850080</b>	480	800	450	PCS	
<b>0850090</b>	480	900	450	PCS	
<b>0850100</b>	480	1000	450	PCS	

**Front-Back Seat**

Upholstered seat with marine grade Skay covering. The backrest can be positioned front or back, allowing a driving and working mode position.

Code	W mm	L mm	H mm	UM	€
<b>0850050</b>	520	500	500	PCS	

**Ocean 52 Flip-Op Seat**

Polyethylene shell offshore upholstered seat. Marine grade Skay covering. The seat may be lifted to allow standing drive mode with back rest.

Code	W mm	L mm	H mm	Colour	UM	€
<b>0857008</b>	500>600	550	600	WHITE	PCS	

**Ocean 51 Flip-Op Seat**

Polyethylene shell offshore upholstered seat. Marine grade Skay covering. The seat may be lifted to allow standing drive mode with back rest.

Code	W mm	L mm	H mm	Colour	UM	€
<b>0857003</b>	500>600	550	600	WHITE/BLUE	PCS	

**Pro Casting Seat**

Upholstered seat with resistant marine grade Skay covering. Reinforced plastic base, comfortable design and backrest edge. Ideal as a stool, as a support for driving and fishing, or as a sitting corner.

Code	W mm	L mm	H mm	Colour	UM	€
<b>0851200</b>	280	381	127	WHITE	PCS	
<b>0851204</b>	280	381	127	GREY	PCS	



**Eltex Basic Seat**

Sturdy Polyethylene Basic seat. Tough and strong, completely maintenance free.

Code	W mm	L mm	H mm	Colour	UM	€
<b>0852010</b>	476	482	406	WHITE	PCS	
<b>0852012</b>	476	482	406	GREY	PCS	

**Eltex Compact Seat**

Sturdy Polyethylene Compact seat. Tough and strong, completely maintenance free. To be completed with cushions for better seat comfort.

Code	W mm	L mm	H mm	Accessories	UM	€
<b>0852040</b>	400	400	400		PCS	
<b>0853040</b>				Cushions	PCS	

**Eltex Classic Seat**

Sturdy Polyethylene Classic seat. Tough and strong, completely maintenance free. To be completed with cushions for better seat comfort.

Code	W mm	L mm	H mm	Accessories	UM	€
<b>0852050</b>	510	400	420		PCS	
<b>0853050</b>				Cushions	PCS	

**Eltex Comfort Seat**

Sturdy Polyethylene Comfort seat. Tough and strong, completely maintenance free. To be completed with cushions for better seat comfort.

Code	W mm	L mm	H mm	Accessories	UM	€
<b>0852055</b>	520	520	450		PCS	
<b>0853055</b>				Cushions	PCS	

**Eltex Marine Seat**

Resistant Marine type Polyethylene folding seat. Tough and strong, completely maintenance free. Can be completed with cushions for better seat comfort.

Code	W mm	L mm	H mm	Accessories	UM	€
<b>0851142</b>	425	380	475		PCS	
<b>0853042</b>				Cushions	PCS	



**Cushion**

Comfortable acrylic fabric cushion. Water-repellent and UV rays resistant. The stable indelible colors remain lively for at least 3 years of continuous use. Endowed with velcro in order to put together more cushions. Washable cover with zipper.

Code	Dim cm	Colour	UM	€
<b>5805076</b>	50 x 50	BLUE NAVY	PCS	
<b>5805077</b>	50 x 50	GREY	PCS	

**Extendible Cushion**

Comfortable acrylic fabric cushion. Water-repellent and UV rays resistant. The stable indelible colors remain lively for at least 3 years of continuous use. Endowed with velcro in order to put together more cushions. Washable cover with zipper.

Code	Dim cm	Colour	UM	€
<b>5805073</b>	45 x 45	BLUE NAVY	PCS	
<b>5805074</b>	45 x 45	GREY	PCS	

**Bench Cushion**

Resistant marine grade Skay cushion with high density foam padding. Complete with zip closure and press buttons fixing flaps.

Code	H mm	Colour	UM	€
<b>0851216</b>	600 x 300 x 50	WHITE	PCS	
<b>0851218</b>	600 x 300 x 50	GREY	PCS	
<b>0851220</b>	1200 x 300 x 50	WHITE	PCS	
<b>0851222</b>	1200 x 300 x 50	GREY	PCS	

**Adjustable Sitting Box**

Adjustable base Polyethylene dry storage seat for inflatables. Mounting: place the seat into the tender when half inflated, adjust the width then finish inflating. Can contain fuel tanks.

Code	Dim cm	UM	€
<b>0832068</b>	32 x 60<->80	PCS	

**Fiberglass Chests**

Sturdy Fiberglass frame dry storage box.

Code	L cm	W cm	H cm	UM	€
<b>0832005</b>	60	45	40	PCS	
<b>0832008</b>	79	45	40	PCS	



**Master Fix Seat Pedestal**

Anodized Aluminum fixed height Master seat pedestal. Swivel mount top and sliding system. Universal mount for all seats.

Code	H mm	Base ø mm	UM	€
<b>0846746</b>	475	230	PCS	

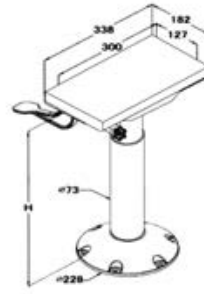
**Master Adjustable Seat Pedestal**

Anodized Aluminum adjustable height Master seat pedestal. Swivel mount top and sliding system. Universal mount for all seats.

Code	H mm	Base ø mm	UM	€
<b>0846862</b>	435<>635	230	PCS	

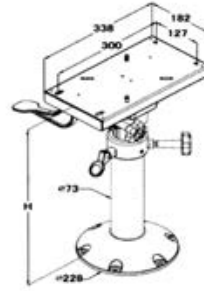
**Ocean Adjustable Seat Pedestal**

Anodized Aluminum Ocean seat pedestal with manual height adjustment. Swivel mount top and sliding system. Elegant and very sturdy, universal mount for all seats.

Code	H mm	Base ø mm	UM	€
<b>0846865</b>	435<>635	300	PCS	

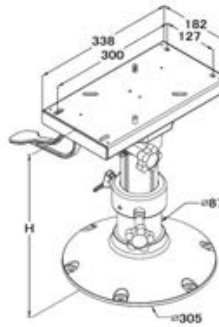
**Ocean Gas-Power Adjustable Seat Pedestal**

Anodized Aluminum Ocean Gas Power seat pedestal with gas height adjustment. Swivel mount top and sliding system. Elegant and very sturdy, universal mount for all seats.

Code	H mm	Base ø mm	UM	€
<b>0846880</b>	350<>470	300	PCS	
<b>0846885</b>	460<>635	300	PCS	

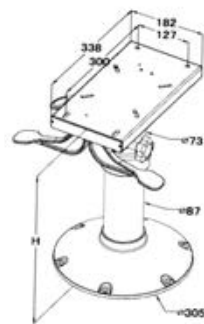
**Belle Adjustable Seat Pedestal**

Anodized Aluminum seat pedestal with swivel mount top. Manual height adjustment. Universal mount for all seats.

Code	H mm	Base ø mm	UM	€
<b>0846850</b>	330<>430	250	PCS	



**S/Steel Slim Adjustable Seat Pedestal**

Stainless Steel Slim seat pedestal with swivel mount top. Manual adjustable height with safety pin.

Code	H mm	Base ø mm	UM	€
0845045	500<>700	240	PCS	

**S/Steel Closeable Seat Pedestal**

22 mm Diameter Stainless Steel folding and closable seat pedestal. For bulkhead seats mounting.

Code	Base Dim mm	H mm	UM	€
0845075	280 x 540	740	PCS	

**Low Swiveling Seat Pedestal**

Rotating and sliding base for seats mounting on benches and storage boxes. Universal mount for all seats.

Code	Dim mm	H mm	Base ø mm	UM	€
0846715	338 x 182	153	230	PCS	

**Fixed Seat Base with Slide**

Fixed sliding system base for mounting seats on benches and storage boxes. Universal mount for all seats.

Code	Dim mm	H mm	UM	€
0847543	338 x 182	70	PCS	

**S/Steel Flat Swiveling Seat Pedestal**

Stainless Steel swiveling flat base. For mounting seats on benches and storage boxes.

Code	Dim mm	UM	€
0847545	172 x 172 x H23	PCS	

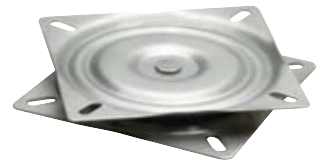
**Extractable Seat Pedestal**

Extractable and swiveling seat base made of reinforced ABS. For mounting seats on benches and storage boxes. Suitable for mounting on multiple positions. Holes diagonal wheelbase from 165 to 200 mm.

Code	Dim mm	UM	€
0847546	173 x 173 x H55	PCS	

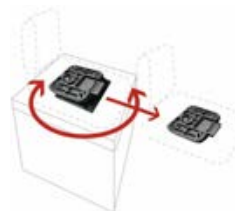



**Class 1 Table Pedestal**

Flush mount base Anodized Aluminum satin finish stowable table pedestal. High quality manufacture. Height: 70 cm.

Code	Tube ø	Top ø	Base ø	Extra	UM	€
<b>0840003</b>	60mm	17cm	17cm		PCS	
<b>0840124</b>				2nd Base	PCS	

**Class 2 Table Pedestal**

Flush mount base Anodized Aluminum stowable table pedestal. Height: 62 cm.

Code	Tube ø	Top ø	Base ø	Extra	UM	€
<b>0840005</b>	55mm	17cm	16cm		PCS	
<b>0840008</b>				2nd Base	PCS	

**Twist Lock Table Pedestal**

Satinized Anodized Aluminum detachable table pedestal. Twist-Lock surface mount base (thru deck hole not needed) with 6 screw holes (wheelbase 145 mm). Height: 70 cm.

Code	Tube ø	Top ø	Base ø	Extra	UM	€
<b>0840004</b>	55mm	17cm	18cm		PCS	
<b>0840114</b>				2nd Base	PCS	

**Twist Lock Telescopic Table Pedestal**

Twist-Lock surface mount low profile base (thru deck hole not needed). Anodized Aluminum satin finish telescoping table pedestal. High quality manufacture. Height 50<>70 cm.

Code	Tube ø	Top ø	Base ø	Extra	UM	€
<b>0840120</b>	60mm	17cm	18cm		PCS	
<b>0840114</b>				2nd Base	PCS	

**Stainless Steel Table Pedestal**

Flush mount base polished Stainless Steel stowable table pedestal. Height: 70 cm.

Code	Tube ø	Top ø	Base ø	Extra	UM	€
<b>0840010</b>	50mm	16cm	16cm		PCS	
<b>0840013</b>				2nd Base	PCS	

**ZW Table Pedestal - Flat Base**

Gas adjustment, strong and careful manufacture Zwaardvis Anodized Aluminum telescoping table pedestal. Surface mount base (thru deck hole not needed).

Code	H mm	UM	€
<b>0840022</b>	500<>840	PCS	

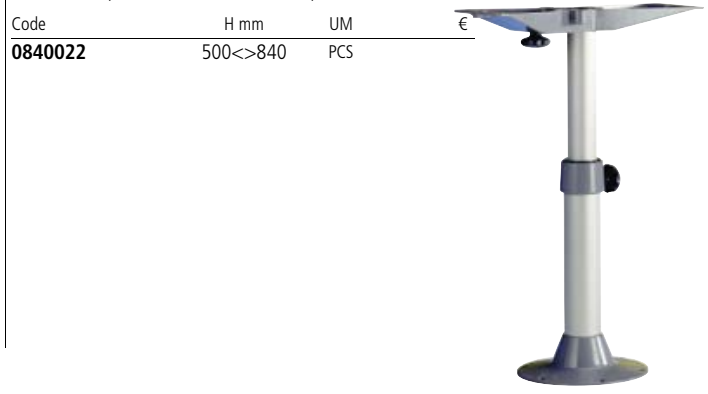
**- TABLE TOPS -****W Round Table Top and Pedestals**

Reinforced Plastic round table.

Code	ø cm	Pedestals	UM	€
<b>0840254</b>	60		PCS	
<b>0840003</b>		Class 1	PCS	
<b>0840004</b>		Twist-Lock	PCS	
<b>0840120</b>		Twist-Lock Telescopic	PCS	

**W Oval Table Top and Pedestals**

Reinforced Plastic oval table.

Code	Dim cm	Pedestals	UM	€
<b>0840249</b>	45 x 75		PCS	
<b>0840003</b>		Class 1	PCS	
<b>0840004</b>		Twist-Lock	PCS	
<b>0840120</b>		Twist-Lock Telescopic	PCS	



**Rako Foldable Support**

"Rako" Stainless Steel folding table and shelf support.

Code	L mm	Max Kg	UM	€
<b>0840033</b>	300	40	PCS	

**Southco Foldable Support**

"Southco" Anodized Aluminum folding table and shelf support.

Code	L mm	Max Kg	UM	€
<b>0840061</b>	330/165	100	PCS	
<b>0840062</b>	480/240	100	PCS	

**- OUTDOOR FOLDING DECK TABLES -****Forma Deck Service Folding Tables**

Marathon M300 round top and M350 square top service folding tables. Perfectly finished Anodized Aluminum strong frame. Superior quality humidity and UV rays resistant Melamine table top. Anodized Aluminum reinforced corners. Stainless Steel hardware.

Code	Ref	Table Top cm	Height cm	UM	€
<b>0840612</b>	M300 Round	ø 60	48	PCS	
<b>0840614</b>	M350 Square	60 x 60	48	PCS	

**Forma Melamine Top Round Folding Tables**

Marathon M250H - M450H elegant folding tables. Perfectly finished Anodized Aluminum strong frame. Superior quality humidity and UV rays resistant Melamine table top. Anodized Aluminum reinforced corners. Stainless Steel hardware.

Code	Ref	Table Top cm	Height cm	UM	€
<b>0840608</b>	M250H	88 x 51	70	PCS	
<b>0840609</b>	M450H	88 x 60	70	PCS	

**Forma Melamine Top Folding Tables**

Marathon M200 - M400 - M400H - M600 elegant folding tables. Perfectly finished Anodized Aluminum strong frame. Superior quality humidity and UV rays resistant Melamine table top. Anodized Aluminum reinforced corners. Stainless Steel hardware. The M600 table can be set in two heights: 56 and 73 cm.

Code	Ref	Table Top cm	Height cm	UM	€
<b>0840602</b>	M200	88 x 44	61	PCS	
<b>0840604</b>	M400	88 x 60	61	PCS	
<b>0840610</b>	M400H	88 x 60	61	PCS	
<b>0840606</b>	M600	120 x 75	56 / 73	PCS	



**Forma Teak Top Folding Tables**

Marathon M400T and M600T elegant folding tables. Perfectly finished Anodized Aluminum strong frame. Superior quality humidity and UV rays resistant Teak table top. Solid Teak corners. Stainless Steel hardware. The M600T table can be set in two heights: 56 and 73 cm.

Code	Ref	Table Top cm	Height cm	UM	€
<b>0840605</b>	M400T	88 x 63	61	PCS	
<b>0840607</b>	M600T	122 x 66	56 / 73	PCS	

**MB Round Teak Folding Table**

Marine grade UV rays resistant superior quality Teak Marine Business folding tables. Stainless Steel hardware.

Code	Table Top cm	Height cm	UM	€
<b>0840624</b>	ø 80	75	PCS	



MARINE BUSINESS

**MB Teak Folding Tables**

Marine grade and UV rays resistant superior quality Teak Marine Business folding tables. Stainless Steel hardware.

Code	Table Top cm	Height cm	UM	€
<b>0840622</b>	80 x 60	75	PCS	
<b>0840623</b>	120 x 60	75	PCS	



MARINE BUSINESS

**MB Adjustable Teak Folding Table**

Marine grade UV rays resistant superior quality Teak Marine Business folding table. Stainless Steel hardware. Endowed with two winglets that reduces the table top to 120 x 40 cm. Can be set in two heights: 60 and 75 cm.

Code	Table Top cm	Height cm	UM	€
<b>0840625</b>	120 x 80	60 / 75	PCS	



MARINE BUSINESS

**MB Teak Folding Director Chair**

Marine grade UV rays resistant superior quality Teak Marine Business folding director chair. Stainless Steel hardware. Marine grade and sun resistant ripstop Olefin fabric.

MARINE BUSINESS®

Code	Dim cm	Colour	UM	€
<b>0860604</b>	52 x 48 x H90	Ecrù White	PCS	
<b>0860605</b>	52 x 48 x H90	Blue Navy	PCS	

**MB Teak Folding Chair**

Marine grade UV rays resistant superior quality Teak Marine Business folding chair. Stainless Steel hardware. Marine grade and sun resistant ripstop, waterproof and transpiring fabric.

MARINE BUSINESS®

Code	Dim cm	Colour	UM	€
<b>0860608</b>	55 x 55 x H88	Ecrù White	PCS	
<b>0860609</b>	55 x 55 x H88	Blue Navy	PCS	

**MB Teak Folding Deck Stool**

Marine grade and UV rays resistant superior quality Teak Marine Business folding deck stools. Stainless Steel hardware. Marine grade and sun resistant ripstop Olefin fabric.

MARINE BUSINESS®

Code	Dim cm	Colour	UM	€
<b>0860612</b>	45 x 36 x H46	Ecrù White	PCS	
<b>0860614</b>	45 x 36 x H46	Blue Navy	PCS	



**Marathon M700 Folding Deck Stool**

Reliable and elegant Marathon M700 deck stool by Forma. Perfectly finished Anodized Aluminum strong frame, non-skid inserts. Polyfor Fabric - 100% superior quality 420gr/m<sup>2</sup> Polyester. Stainless Steel hardware.



Code	Seat H cm	Chair H x Width cm	Colour	UM	€
<b>0860420</b>	42	46 x 46	Blue Navy	PCS	
<b>0860421</b>	42	46 x 46	White	PCS	

**Marathon M100P Folding Chair**

Elegant and handy Marathon M100P folding chair by Forma. Perfectly finished strong Anodized Aluminum frame, non-skid inserts. Textilene 650gr/m<sup>2</sup> superior quality marine grade canvas. Reliable sturdy plastic UV resistant armrests. Stainless Steel hardware.



Code	Seat H cm	Chair H x Width cm	Colour	UM	€
<b>0860430</b>	42	82 x 47	Royal Blue	PCS	
<b>0860431</b>	42	82 x 47	White	PCS	

**Marathon M100 Folding Chair**

Classic and elegant Marathon M100 folding chair by Forma. Perfectly finished strong Anodized Aluminum frame, non-skid inserts. Superior quality Polyfor marine grade canvas - 100% Polyester 420gr/m<sup>2</sup>. Elegant and comfortable real Teak wood armrests. Stainless Steel hardware.



Code	Seat H cm	Chair H x Width cm	Colour	UM	€
<b>0860432</b>	42	82 x 47	Blue Navy	PCS	
<b>0860433</b>	42	82 x 47	White	PCS	



**Marathon M150 Folding Chair**

Classic and comfortable (high seatback) Marathon M150 folding chair by Forma. Perfectly finished strong Anodized Aluminum frame, non-skid inserts. Superior quality Polyfor marine grade canvas - 100% Polyester 420gr/m2. Elegant and comfortable real Teak wood armrests. Stainless Steel hardware.



Code	Seat H cm	Chair H x Width cm	Colour	UM	€
<b>0860452</b>	43	92 x 47	Blue Navy	PCS	
<b>0860453</b>	43	92 x 47	White	PCS	

**Astron A6000 Folding Chair**

High end (super comfortable) very elegant Astron A6000 folding chair by Forma. Perfectly finished light and very strong Anodized Aluminum frame with casted joints. Nautolex Superior marine grade canvas. Stainless Steel hardware.



Code	Seat H cm	Chair H x Width cm	Colour	UM	€
<b>0860456</b>	46	86 x 47	Blue Navy	PCS	
<b>0860457</b>	46	86 x 47	White	PCS	

**Astron A6000T Folding Chair**

High end (super comfortable) very elegant Astron A6000T folding chair by Forma. Perfectly finished light and very strong Anodized Aluminum frame with casted joints. Nautolex Superior marine grade canvas. Elegant real Teak wood armrests. Stainless Steel hardware.



Code	Seat H cm	Chair H x Width cm	Colour	UM	€
<b>0860460</b>	46	86 x 47	Blue Navy	PCS	
<b>0860461</b>	46	86 x 47	White	PCS	



**Chromed Brass Low Round Portlight**

Round Brass portlights complete with trim ring. Neck height 12 mm.

Code	ø mm	Cutout mm	Finishing	UM	€
<b>1610000</b>	153	125	Chromed Brass	PCS	
<b>1610015</b>	175	152	Chromed Brass	PCS	
<b>1610017</b>	207	175	Chromed Brass	PCS	



**Polished Brass Low Round Portlight**

Round Brass portlights complete with trim ring. Neck height 12 mm.

Code	ø mm	Cutout mm	Finishing	UM	€
<b>1610500</b>	153	125	Polished Brass	PCS	
<b>1610515</b>	175	152	Polished Brass	PCS	
<b>1610517</b>	207	175	Polished Brass	PCS	



**Chromed Brass High Round Portlight**

Round Brass portlights with trim ring included.

Code	ø mm	Cutout mm	Neck H mm	Finishing	UM	€
<b>1610019</b>	264	195	25	Chromed Brass	PCS	
<b>1610020</b>	264	195	50	Chromed Brass	PCS	
<b>1610023</b>	300	235	25	Chromed Brass	PCS	
<b>1610024</b>	300	235	50	Chromed Brass	PCS	
<b>1610038</b>	470	385	25	Chromed Brass	PCS	
<b>1610039</b>	470	385	50	Chromed Brass	PCS	



**Polished Brass High Round Portlight**

Round Brass portlights with trim ring included.

Code	ø mm	Cutout mm	Neck H mm	Finishing	UM	€
<b>1610519</b>	264	195	25	Polished Brass	PCS	
<b>1610520</b>	264	195	50	Polished Brass	PCS	
<b>1610523</b>	300	235	25	Polished Brass	PCS	
<b>1610524</b>	300	235	50	Polished Brass	PCS	
<b>1610538</b>	470	385	25	Polished Brass	PCS	
<b>1610539</b>	470	385	50	Polished Brass	PCS	



**MTM Round Portlights**

Nylon frame and Acrylic glass round portlights. Complete with trim ring. Screws not included. Spigot Size 30 mm. CE EN ISO12216 Certified.



Code	ø mm	Cutout ø mm	Colour	Spare Parts	UM	€
<b>1614016</b>	220	160	WHITE		PCS	
<b>1614021</b>	270	210	WHITE		PCS	
<b>1614026</b>	320	260	WHITE		PCS	
<b>1614116</b>	220	160	BLACK		PCS	
<b>1614121</b>	270	210	BLACK		PCS	
<b>1614126</b>	320	260	BLACK		PCS	
<b>3835201</b>				Seal Kit	PCK	

**MTM Rectangular Portlights**

Nylon frame and Acrylic glass rectangular portlights. Complete with trim ring. Screws not included. Spigot Size 30 mm. CE EN ISO12216 Cat.A/B/C/D Certified.



Code	L mm	H mm	Cutout mm	Colour	Spare Parts	UM	€
<b>1604040</b>	400	200	340 x 140	WHITE		PCS	
<b>1604050</b>	500	250	440 x 190	WHITE		PCS	
<b>1604140</b>	400	200	340 x 140	BLACK		PCS	
<b>1604150</b>	500	250	440 x 190	BLACK		PCS	
<b>3835201</b>					Seal Kit	PCK	

**FL-Sea Round Portlights**

UV Rays resistant ABS stabilized round portlight with 4 mm thickness tempered glass. Complete with trim ring and 316 Stainless Steel accessories.

Code	ø mm	Cutout mm	UM	€
<b>1614421</b>	215	147	PCS	
<b>1614426</b>	265	197	PCS	

**FL-Sea Oval Portlights**

UV Rays resistant ABS stabilized oval portlight with 4 mm thickness tempered glass. Complete with trim ring and 316 Stainless Steel accessories.

Code	L mm	H mm	Cutout mm	UM	€
<b>1614840</b>	410	220	323 x 130	PCS	

**FL-Sea Rectangular Portlights**

UV Rays resistant ABS stabilized rectangular portlight with 4 mm thickness tempered glass. Complete with trim ring and 316 Stainless Steel accessories.

Code	L mm	H mm	Cutout mm	UM	€
<b>1604440</b>	400	200	320 x 128	PCS	





**S/Steel Fix Oval Portlight**

Acrylic glass and Stainless Steel frame fixed oval portlight that can not be opened.

Code	External dim mm	Cutout mm	UM	€
1620061	127 x 400	94 x 363	PCS	
1620062	151 x 490	120 x 458	PCS	
1620063	198 x 457	146 x 405	PCS	

**S/Steel Open Oval Portlight**

Acrylic glass and Stainless Steel frame oval portlight that can be opened.

Code	External dim mm	Cutout mm	UM	€
1620071	203 x 461	156 x 414	PCS	
1620072	216 x 472	186 x 430	PCS	

**G-Type Oval Portlight**

Anodized Aluminum Giot type portlight with watertight Acrylic glass with casted construction and double-side sealing gasket. Great view range thanks to the flat handle. Maximum bulkhead thickness 27 mm.

Code	External dim mm	Cutout mm	Accessories	UM	€
1620002	397 x 197	375 x 175		PCS	
1620202			Bug screen	PCS	

**G-Type Square Portlight**

Anodized Aluminum Giot type portlight with watertight Acrylic glass with casted construction and double-side sealing gasket. Great view range thanks to the flat handle. Maximum bulkhead thickness 27 mm.

Code	External dim mm	Cutout mm	Bug Screen	UM	€
1620000	325 x 178	303 x 156		PCS	
1620001	369 x 193	347 x 171		PCS	
1620004	427 x 178	405 x 156		PCS	
1620003	451 x 193	429 x 171		PCS	
1620005	649 x 193	627 x 171		PCS	
1620006	451 x 266	429 x 244		PCS	
1620007	369 x 273	347 x 251		PCS	
1620200			Ref. 1620000	PCS	
1620201			Ref. 1620001	PCS	
1620204			Ref. 1620004	PCS	
1620203			Ref. 1620003	PCS	
1620205			Ref. 1620005	PCS	
1620206			Ref. 1620006	PCS	
1620207			Ref. 1620007	PCS	



**Vetus Libero Hatches**

Anodized Aluminum structure and frame Vetus hatches with 12mm thickness smoky Acrylic lens. Fitted with friction type hinges allowing it to stay open in any position up to 180°. On deck height: 50mm. CE class All certified.



Code	Ref	External Dim mm	Cutout mm	Accessories	UM	€
1630420	20	260 x 260	200 x 200		PCS	
1630434	34	400 x 255	340 x 195		PCS	
1630445	32	510 x 380	450 x 320		PCS	
1630450	37	560 x 430	500 x 370		PCS	
1630455	50	560 x 560	500 x 500		PCS	
1630462	62	680 x 680	620 x 620		PCS	
1630520				Size 20 Bug Screen	PCS	
1630534				Size 34 Bug Screen	PCS	
1630545				Size 32 Bug Screen	PCS	
1630550				Size 37 Bug Screen	PCS	
1630555				Size 50 Bug Screen	PCS	
1630562				Size 62 Bug Screen	PCS	



**Vetus Planus Hatches**

Anodized Aluminum frame Vetus hatches with 10 mm thickness smoky Acrylic lens. Fitted with friction type hinges allowing it to stay open in any position up to 180°. On deck height: 20 mm (31 mm with handles). CE class All certified.

**New**



Code	Ref	External Dim mm	Cutout mm	Accessories	UM	€
1630401	23	280 x 280	230 x 230		PCS	
1630403	34	390 x 260	340 x 210		PCS	
1630405	40	424 x 424	374 x 374		PCS	
1630406	45	474 x 474	424 x 424		PCS	
1630407	50	521 x 521	471 x 471		PCS	
1630502				Size 23 Bug Screen	PCS	
1630505				Size 34 Bug Screen	PCS	
1630506				Size 40 Bug Screen	PCS	
1630507				Size 45 Bug Screen	PCS	
1630508				Size 50 Bug Screen	PCS	



**Vetus FGH Flush Hatch**

Anodized Aluminum frame Vetus flush deck hatch built in compliance with class All CE rules. Completely recessed into the deck, there are no protruding parts. 10mm thickness smoke colour Acrylic lid.



Code	External Dim mm	Cutout mm	Accessories	UM	€
1630458	580 x 580	507 x 507		PCS	
1630558			Bug Screen	PCS	



**G-Type Square Hatch**

Anodized Aluminum square frame Giot type hatch with light smoke grey 10 mm Methacrylate glass. Leveled gasket and handles for a watertight closure.



Code	Size Ref	External Dim mm	Cutout mm	Handles	UM	€
1630015	00	271 x 271	211 x 211	1	PCS	
1630016	10	320 x 320	260 x 260	1	PCS	
1630019	40	481 x 481	421 x 421	2	PCS	
1630020	44	502 x 502	442 x 442	2	PCS	
1630022	60	567 x 567	507 x 507	2	PCS	
1630023	70	687 x 687	627 x 627	2	PCS	

**G-Type Square Hatch**

Anodized Aluminum square frame Giot type hatch with light smoke grey 10 mm Methacrylate glass. Leveled gasket and handles for a watertight closure.



Code	Size Ref	External Dim mm	Cutout mm	Handles	UM	€
1630014	03	291 x 236	231 x 176	1	PCS	
1630017	20	407 x 262	347 x 202	1	PCS	
1630026	25	403 x 320	343 x 260	1	PCS	
1630018	30	517 x 387	457 x 327	2	PCS	
1630027	50	567 x 437	507 x 377	2	PCS	
1630021	54	567 x 452	507 x 392	2	PCS	

**G-Type Round Hatch**

Anodized Aluminum round frame Giot type hatch with light smoke grey 10 mm Methacrylate glass. Leveled gasket and handles for a watertight closure.



Code	Size Ref	External Dim mm	Cutout mm	UM	€
1630064	18	ø 484	ø 420	PCS	
1630066	22	ø 586	ø 522	PCS	



**Square Hatches Accessories**

Accessories for square hatches.



Code	Size	Ref	UM	€
1630115	00	Frame	PCS	
1630215	00	Bug screen	PCS	
1630116	10	Frame	PCS	
1630216	10	Bug screen	PCS	
1630119	40	Frame	PCS	
1630219	40	Bug screen	PCS	
1630120	44	Frame	PCS	
1630220	44	Bug screen	PCS	
1630122	60	Frame	PCS	
1630222	60	Bug screen	PCS	
1630123	70	Frame	PCS	
1630223	70	Bug screen	PCS	



**Rectangular Hatches Accessories**

Accessories for rectangular hatches.



Code	Size	Ref	UM	€
1630114	03	Frame	PCS	
1630214	03	Bug screen	PCS	
1630117	20	Frame	PCS	
1630217	20	Bug screen	PCS	
1630126	25	Frame	PCS	
1630226	25	Bug screen	PCS	
1630118	30	Frame	PCS	
1630218	30	Bug screen	PCS	
1630127	50	Frame	PCS	
1630227	50	Bug screen	PCS	
1630121	54	Frame	PCS	
1630221	54	Bug screen	PCS	

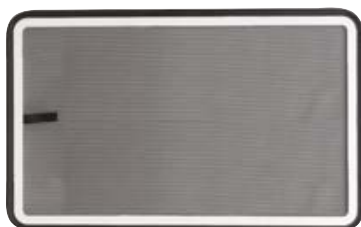

**Round Hatches Accessories**

Accessories for round hatches.



Code	Size	Ref	UM	€
1630164	18	Frame	PCS	
1630264	18	Bug screen	PCS	
1630166	22	Frame	PCS	
1630266	22	Bug screen	PCS	

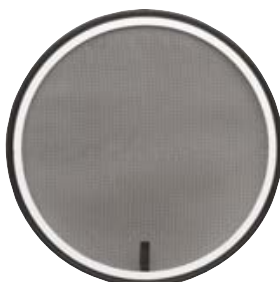

**JBA Vent 20D Hatch**

Weather, shock, solvent and UV resistant, almost indestructible Saralon Polypropylene resin frame ventilation hatch. Shock and scratch resistant tempered glass lens for perfect clarity. Trim ring included. 28 mm on deck height. CE approval areas: II.

Code	External Dim mm	Cutout mm	Accessories	UM	€
1634202	585 x 330	530 x 280		PCS	
1635202			Bug Screen	PCS	
1635302			Privacy Screen	PCS	



*Jim Black*

**JBA Vent 10 Round Hatch**

Weather, shock, solvent and UV resistant, almost indestructible Saralon Polypropylene resin frame ventilation hatch. Shock and scratch resistant tempered glass lens for perfect clarity. Trim ring included. 28 mm on deck height. CE approval areas: II.

Code	External Dim ø mm	Cutout ø mm	UM	€
1634008	356	311	PCS	



*Jim Black*

**JBA Vent Hatches**

Weather, shock, solvent and UV resistant, almost indestructible Saralon Polypropylene resin frame ventilation hatch. Shock and scratch resistant tempered glass lens for perfect clarity. Trim ring included. 28 mm on deck height. CE approval areas: II.

Code	Ref	External Dim mm	Cutout mm	Accessories	UM	€
1634010	10	300 x 300	255 x 255		PCS	
1634017	30	520 x 385	470 x 343		PCS	
1635010				Bug Screen Size 10	PCS	
1635011				Privacy Screen Size 10	PCS	
1635021				Bug Screen Size 30	PCS	
1635022				Privacy Screen Size 30	PCS	



*Jim Black*

**JBA Vent Spare Parts**

Jim Black Vent spare parts.

Code	Ref	Hatch	UM	€
1635512	Adjuster Arm	1634202	PCS	
1635513	Adjuster Arm	1634008	PCS	
1635510	Adjuster Arm	1634010	PCS	
1635516	Adjuster Arm	1634017	PCS	
1635556	L Handle	(All)	PCS	
1635557	R Handle	(All)	PCS	
3835204	Seal	(All)	PCK	



*Jim Black*

LADDERS GANGWAYS/STAFFS SEATS/PORT LIGHTS AIR VENTS

3

**JBA Escape WF Hatch**

Weather, shock, solvent and UV resistant, almost indistructible Saralon Polypropylene resin frame escape hatch. External handles for emergency escape. Shock and scratch resistant tempered glass lens for perfect clarity. Trim ring included. 28 mm on deck height. CE approval areas: II.

*Jim Black*

Code	Ref	External Dim mm	Cutout mm	Accessories	UM	€
1634215	44	490 x 490	440 x 440		PCS	
1634217	48	525 x 525	480 x 480		PCS	
1634218	60	565 x 565	518 x 518		PCS	
1635016				Bug Screen Size 44	PCS	
1635017				Privacy Screen Size 44	PCS	
1635023				Bug Screen Size 48	PCS	
1635024				Privacy Screen Size 48	PCS	
1635019				Bug Screen Size 60	PCS	
1635020				Privacy Screen Size 60	PCS	



**JBA Escape Hatches Spare Parts**

Jim Black hatches spare parts.

Code	Ref	Hatch	UM	€
1635514	Adjuster Arm	1634215	PCS	
1635515	Adjuster Arm	1634217	PCS	
1635517	Adjuster Arm	1634218	PCS	
1635524	Adjuster Arm	1634204	PCS	
1635554	Lock Handle	(All)	PCS	
1635555	No-Lock Handle	(All)	PCS	
3835204	Seal	(All)	PCK	



*Jim Black*

**- PRIVACY CURTAINS AND MOSQUITO NETS -**

**Navishell Hatch Cover**

Woven acrylic fabric hatch cover. Water repellent and UV rays resistant, this fabric guarantees a high level of colour fastness, at least 3 years non-fading guarantee. Complete with mosquito mesh.

**NAVISHELL**

Code	Dim cm	Colour	UM	€
3215629	45 x 32	BLUE NAVY	PCS	
3215630	42 x 42	BLUE NAVY	PCS	
3215631	50 x 37	BLUE NAVY	PCS	
3215632	50 x 50	BLUE NAVY	PCS	
3215633	62 x 62	BLUE NAVY	PCS	
3215634	70 x 70	BLUE NAVY	PCS	
3215650	45 x 32	GREY	PCS	
3215651	42 x 42	GREY	PCS	
3215652	50 x 37	GREY	PCS	
3215653	50 x 50	GREY	PCS	
3215654	62 x 62	GREY	PCS	
3215655	70 x 70	GREY	PCS	





**Water Line Mosquito Nets for Hatches**

Mosquito nets for hatches available in three dimensions. Allow the ventilation of the boat without letting insects and mosquitos in.

Can be mounted with a suction cup or a magnet from the inside.

Code	Ref	Hatch Dim (A x B) cm	Dim (D x C) cm	UM	€
3272541	1405 - Small	30 x 30	35 x 35	PCS	
3272542	1410 - Regular	52 x 52	60 x 60	PCS	
3272543	1415 - Large	72 x 72	80 x 80	PCS	

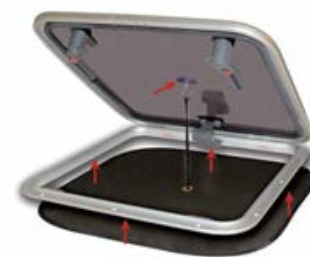

**Water Line Mosquito Nets for Portlights**

Mosquito nets for portlights available in two dimensions.

Allow the ventilation of the boat without letting insects and mosquitos in.

Can be mounted with a suction cup or a magnet from the inside.

3272551 sold in pairs.

Code	Ref	Portlight Dim (A x B) cm	Dim (D x C) cm	UM	€
3272551	1430 - Small	18 x 43	23 x 49	PR	
3272553	1435 - Large	20 x 65	30 x 70	PCS	

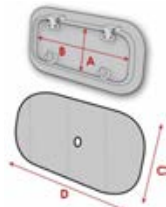
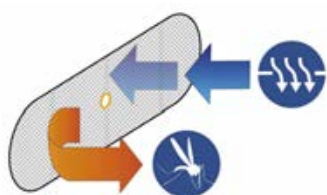

**Water Line Mosquito Net for Companionways**

Mosquito net for companionways.

Allow the ventilation of the boat without letting insects and mosquitos in.

Code	Ref	Dim cm	UM	€
3272556	1460 - Companionway	90 x 18	PCS	

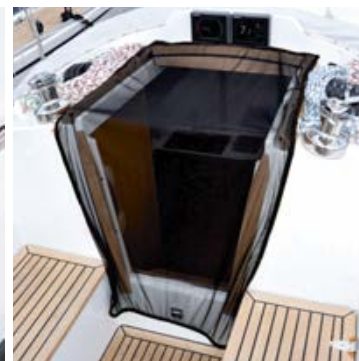
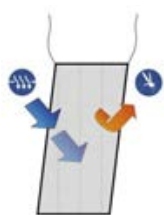

**Hatch Mosquito Net**

Mesh mosquito net with heavy lead edge for a perfect deck adherence.

Code	Dimensions mm	UM	€
3272506	540 x 540	PCS	
3272507	620 x 620	PCS	
3272508	700 x 700	PCS	





**Water Line Blinds for Hatches**

Blinds for hatches available in three dimensions. Thanks to the combination of the two blackout layers and the mosquito net, they allow the recirculation of air without letting mosquitoes or other insects to enter. Can be mounted with a suction cup or a magnet from the inside.

Code	Ref	Hatch Dim (A x B) cm	Dim (D x C) cm	UM	€
<b>3272546</b>	1305 - Small	30 x 30	35 x 35	PCS	
<b>3272547</b>	1310 - Regular	52 x 52	60 x 60	PCS	
<b>3272548</b>	1320 - Large	80 x 80	80 x 80	PCS	

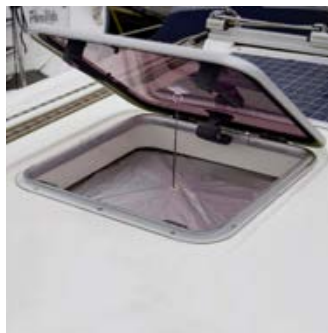

**Water Line Blinds for Portlights**

Blinds for portlights available in two dimensions. Thanks to the combination of the two blackout layers and the mosquito net, they allow the recirculation of air without letting mosquitoes or other insects to enter. Can be mounted with a suction cup or a magnet from the inside. 3272557 sold in pairs.

Code	Ref	Portlight Dim (A x B) cm	Dim (D x C) cm	UM	€
<b>3272557</b>	1330 - Small	18 x 43	23 x 49	PR	
<b>3272558</b>	1335 - Large	20 x 65	30 x 70	PCS	

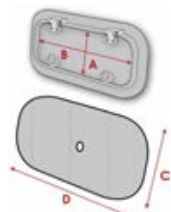

**Water Line Blind for Companionways**

Blind for companionway. Thanks to the combination of the two blackout layers and the mosquito net, they allow the recirculation of air without letting mosquitoes or other insects to enter.

Code	Ref	Dim cm	UM	€
<b>3272560</b>	1360 - Companionway	90 x 180	PCS	

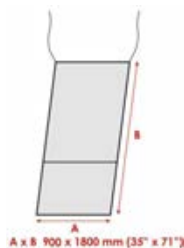
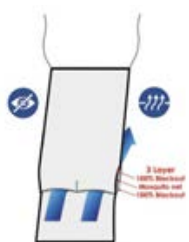

**Sunset Privacy Curtains**

Sunset privacy curtains with Stainless white lacquered frame and Stainless Steel springs. Silver powdered Polyester canvas to reflect sun rays. Easy to mount on hatches and portlights.

Code	W mm	H mm	For Light Cut (Glass) mm	UM	€
<b>3272513</b>	410	490	355 x 455	PCS	
<b>3272514</b>	450	500	410 x 410	PCS	
<b>3272515</b>	550	680	495 x 645	PCS	
<b>3272516</b>	600	760	545 x 720	PCS	
<b>3272517</b>	730	860	675 x 835	PCS	





**Knob C Hatch Adjuster**

Chromed Brass hatch adjusters. Sold in pairs.

Code	Open<>Closed mm	UM	€
<b>1640002</b>	205<>300	PR	

**OC Telescopic Hatch Adjuster**

Chromed Brass telescoping hatch adjuster.

Code	Open<>Closed mm	UM	€
<b>1641022</b>	220<>380	PCS	
<b>1641028</b>	280<>500	PCS	
<b>1641036</b>	360<>640	PCS	

**S/S Telescopic Hatch Adjuster**

Stainless Steel telescoping hatch adjuster.

Code	Open<>Closed mm	UM	€
<b>1641225</b>	250<>425	PCS	
<b>1641230</b>	300<>525	PCS	

**Knob S/S Hatch Adjuster**

Stainless Steel hatch adjuster.

Code	Open<>Closed mm	UM	€
<b>1641320</b>	205<>365	PCS	
<b>1641325</b>	255<>475	PCS	

**S/S Spring Hatch Adjuster**

Stainless Steel spring hatch adjuster.

Code	mm	UM	€
<b>1640000</b>	ø 10 x L220	PCS	
<b>1640001</b>	ø 14 x L260	PCS	

**HD Spring Hatch Adjuster**

Stainless Steel extra strong spring hatch adjuster. Plates dimensions: 45 x 50 mm.

Code	mm	UM	€
<b>1640004</b>	ø 22 x L320	PCS	

**YM S/S Gas Springlifts**

316 Stainless Steel shaft and body gas lift springs, specially designed for soft and easy opening of hatches and engine compartments.



Code	Open L mm	Stroke mm	Load Kg	Shaft mm	Accessories	UM	€
<b>1640140</b>	250	90	10	6		PCS	
<b>1640141</b>	250	90	20	6		PCS	
<b>1640144</b>	375	150	20	8		PCS	
<b>1640145</b>	375	150	30	8		PCS	
<b>1640150</b>	525	220	20	8		PCS	
<b>1640151</b>	525	220	30	8		PCS	
<b>1640155</b>	600	255	40	8		PCS	
<b>1640157</b>	700	300	42	10		PCS	
<b>1640195</b>					D Bracket	PCS	
<b>1640196</b>					E Bracket	PCS	
<b>1640197</b>					F Bracket	PCS	



**Uflex Gas Springlifts**

Superior quality gas springlifts, specially designed for soft and easy opening deck hatches and engine trunks.



Code	Open L mm	Stroke mm	Load Kg	Shaft mm	Accessories	UM	€
1640120	257	95	5	8		PCS	
1640121	257	95	10	8		PCS	
1640122	257	95	20	8		PCS	
1640123	365	142	10	8		PCS	
1640124	365	142	20	8		PCS	
1640125	365	142	30	8		PCS	
1640129	550	234	10	8		PCS	
1640130	550	234	20	8		PCS	
1640131	550	234	30	8		PCS	
1640132	550	234	40	8		PCS	
1640136	683	300	30	10		PCS	
1640137	683	300	40	10		PCS	
1640138	683	300	50	10		PCS	
1640195					D Bracket	PCS	
1640196					E Bracket	PCS	
1640197					F Bracket	PCS	



**Uflex S/S Gas Springlifts**

Superior quality gas springlifts, specially designed for soft and easy opening deck hatches and engine trunks. Stainless Steel shaft and body.



Code	Open L mm	Stroke mm	Load Kg	Shaft mm	Accessories	UM	€
1640160	275	100	5	6		PCS	
1640161	275	100	10	6		PCS	
1640162	275	100	20	6		PCS	
1640163	375	150	10	6		PCS	
1640164	375	150	20	6		PCS	
1640165	375	150	30	6		PCS	
1640166	525	220	10	8		PCS	
1640167	525	220	20	8		PCS	
1640168	525	220	30	8		PCS	
1640169	525	220	40	8		PCS	
1640170	585	250	20	8		PCS	
1640171	585	250	30	8		PCS	
1640172	585	250	40	8		PCS	
1640195					D Bracket	PCS	
1640196					E Bracket	PCS	
1640197					F Bracket	PCS	



**Ulysses Uflex Electric Hatch Springlifts**

Light linear electric hatch springlifts to be mounted as single installation. Designed for opening - even half way - deck hatches and engine room doors. IP65 Waterproof with Stainless Steel shaft. Max load 65 Kg. To be completed with relay and switch to allow opening and closing.



Code	V	Closed mm	Stroke mm	Accessories	UM	€
1640262	12	515	180		PCS	
1640264	24	515	180		PCS	
1640266	12	635	300		PCS	
1640268	24	635	300		PCS	
1640400				12/24V Switch	PCS	
1640412				12V Relay	PCS	
1640424				24V Relay	PCS	

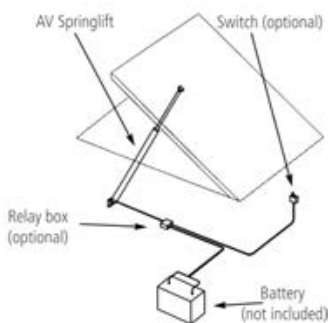

**AV Uflex Electric Hatch Springlifts**

Light linear electric hatch springlifts to be mounted as single installation. Designed for opening - even half way - deck hatches and engine room doors. IP65 Waterproof with Stainless Steel shaft. Max load 120 Kg. To be completed with relay and switch to allow opening and closing.



Code	V	Closed mm	Stroke mm	Accessories	UM	€
1640280	12	677	300		PCS	
1640285	12	827	450		PCS	
1640306	12	977	600		PCS	
1640320	24	677	300		PCS	
1640322	24	827	450		PCS	
1640324	24	977	600		PCS	
1640400				12/24V Switch	PCS	
1640412				12V Relay	PCS	
1640424				24V Relay	PCS	

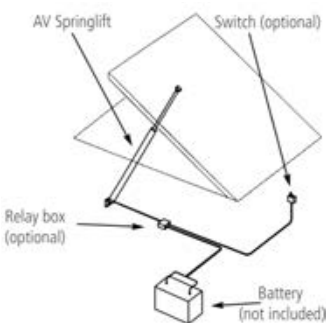

**SQ RubberSeal**

Marine Neoprene adhesive strip. 15 meters pack.

Code	A mm	B mm	m	UM	€
3835110	10	5	15	PCK	
3835112	13	9	15	PCK	
3835116	16	9	15	PCK	



**D RubberSeal**

EPDM Rubber marine adhesive strips. Extremely high quality material, perfect for both internal and external sealing. Ozone and weather resistant. For hatch, port and door sealing. 15 meters pack.

Code	A mm	B mm	Adhesive	m	UM	€
3835129	9,5	9,5	HT	15	PCK	
3835130	12,7	12,7	3M	15	PCK	



**EL Black RubberSeal**

EPDM Rubber marine adhesive strips. Extremely high quality material, perfect for both internal and external sealing. Ozone and weather resistant. For hatch, port and door sealing. 15 meters pack.

Code	A mm	B mm	Adhesive	m	UM	€
3835150	10	5	HT	15	PCK	
3835152	12	8	HT	15	PCK	
3835156	16	9	HT	15	PCK	
3835168	19	12,5	3M	15	PCK	



**EL White RubberSeal**

EPDM Rubber marine adhesive strips. Extremely high quality material, perfect for both internal and external sealing. Ozone and weather resistant. For hatch, port and door sealing. 15 meters pack.

Code	A mm	B mm	Adhesive	m	UM	€
3835151	10	5	HT	15	PCK	
3835157	16	9	HT	15	PCK	
3835169	19	12,5	3M	15	PCK	



**Edge Trim Lock Black**

Trim Lok protective and finishing profile for edges and sharp corners. Flexible PVC trim with internal rust-free metal clips and double gripping lips to provide a stronger grip. Applications: boats and vans doors, fiberglass edges, metal sheets, tractors and cars cabs. 15 meters pack.

Code	Edge Thickness mm	m	UM	€
3835011	2,5<>3,5	15	PCK	
3835013	3,5<>5	15	PCK	
3835007	5<>6,5	15	PCK	



**Edge Trim Lock White**

Trim Lok protective and finishing profile for edges and sharp corners. Flexible PVC trim with internal rust-free metal clips and double gripping lips to provide a stronger grip. Applications: boats and vans doors, fiberglass edges, metal sheets, tractors and cars cabs. 15 meters pack.

Code	Edge Thickness mm	m	UM	€
3835012	2,5<>3,5	15	PCK	
3835014	3,5<>5	15	PCK	
3835008	5<>6,5	15	PCK	



**ArmFlex Seal Profile**

ArmFlex Seal self grip Neoprene seal profile. Flexible PVC trim with internal rust-free metal clips and double gripping lips to provide a stronger grip. Applications: boats and vans doors, fiberglass edges, metal sheets, tractors and cars cabs. 15 meters pack.

Code	Gasket ø mm	For Edge mm	Gasket	m	UM	€
3835015	12	3<5	Top	15	PCK	
3835016	9	3<5	Top	15	PCK	
3835017	12	3<5	Side	15	PCK	
3835018	9	3<5	Side	15	PCK	



**Flex Seal Profile**

PVC self grip profile for 1,5 mm to 4 mm panel thickness. 25 meters pack.

Code	Colour	m	UM	€
3835217	WHITE	25	PCK	
3835216	BLACK	25	PCK	

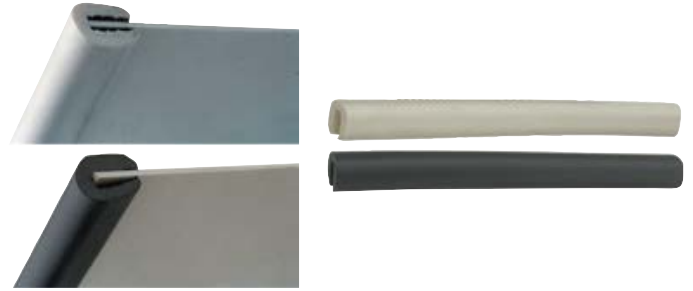

**WindShield 28 Profile**

Flexible windscreen Rubber profile. 15 meters pack.

Code	Colour	m	UM	€
3835530	BLACK	15	PCK	
3835531	WHITE	15	PCK	



**Locking Gasket Profile Seal**

Locking Gasket is a rubber gasket complete with lock strip designed to lock in the installation of stationary windows or windshields. Locking Gasket provides a secure seal between a metal or fiberglass body panel and a glass or plexiglass window. Highly resistant to hard environmental conditions. 15 meters pack.

Code	A mm	B mm	m	UM	€
3835526	4,0<>6,5	2,5<>3,5	15	PCK	
3835528	4,0<>6,5	4,0<>6,5	15	PCK	

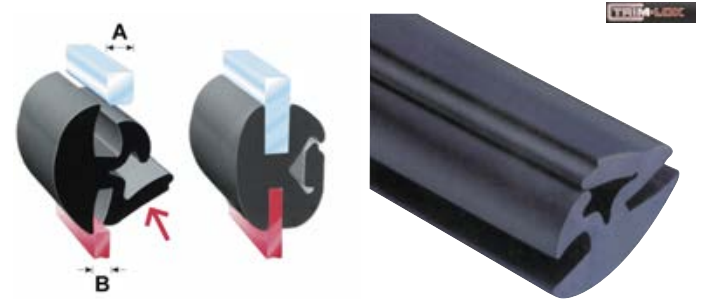

**Redi-Stik Flexible Profile**

Redi-Stik is a flexible self adhesive plastic trim with a decorative Mylar cover. This versatile trim gives an elegant, polished appearance when joining two different surfaces or materials. 15 meters pack.

Code	A mm	B mm	m	UM	€
3835186	8	4,8	15	PCK	
3835189	11	5,5	15	PCK	

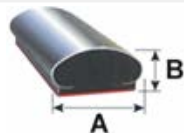

**Blister HatchSeal**

Marine Neoprene adhesive strip. 3 meters pack.

Code	W mm	H mm	m	UM	€
5720307	19	3	3	PCK	
5720308	19	6	3	PCK	



**DC Small Step-on Hatch**

Honeycomb reinforced Plastic 180° opening walkable watertight hatch. Hatch with double opening system: classic and extractable. The extractable system allows to open the hatch in narrow spaces. Deck or bulkhead mount.

Code	Dimensions mm	Passage mm	Colour	Accessories	UM	€
4000129	270 x 373	190 x 290	WHITE		PCS	
4000229	270 x 373	190 x 290	GREY		PCS	
0343300				Lock	PCS	

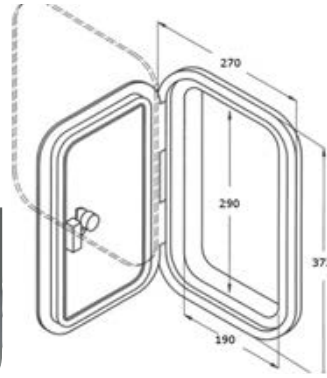

**DC Big Step-on Hatch**

Honeycomb reinforced Plastic 180° opening walkable watertight hatch. Hatch with double opening system: classic and extractable. The extractable system allows to open the hatch in narrow spaces. Deck or bulkhead mount.

Code	Dimensions mm	Passage mm	Colour	Accessories	UM	€
4000144	315 x 440	231 x 356	WHITE		PCS	
4000244	315 x 440	231 x 356	GREY		PCS	
0343300				Lock	PCS	

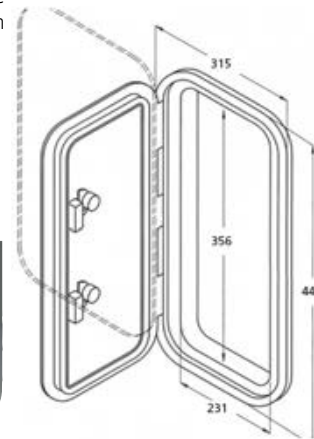

**DC Small Square Step-on Hatch**

Honeycomb reinforced Plastic 180° opening walkable watertight hatch. Hatch with double opening system: classic and extractable. The extractable system allows to open the hatch in narrow spaces. Deck or bulkhead mount.

Code	Dimensions mm	Passage mm	Colour	Accessories	UM	€
4000142	373 x 373	290 x 290	WHITE		PCS	
4000242	373 x 373	290 x 290	GREY		PCS	
0343300				Lock	PCS	

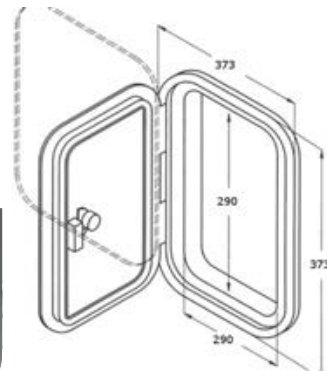

**DC Big Square Step-on Hatch**

Honeycomb reinforced Plastic 180° opening walkable watertight hatch. Hatch with double opening system: classic and extractable. The extractable system allows to open the hatch in narrow spaces. Deck or bulkhead mount.

Code	Dimensions mm	Passage mm	Colour	Accessories	UM	€
4000150	458 x 513	374 x 430	WHITE		PCS	
4000250	458 x 513	374 x 430	GREY		PCS	
0343300				Lock	PCS	

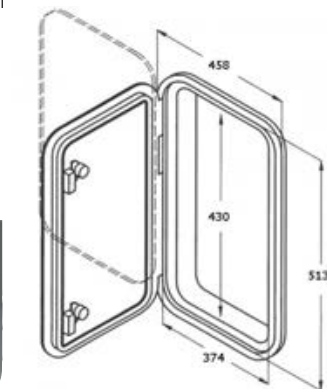

**DC ML Step-on Hatch**

Honeycomb reinforced Plastic 180° opening walkable watertight hatch. Hatch with double opening system: classic and extractable. The extractable system allows to open the hatch in narrow spaces. Deck or bulkhead mount.

Code	Dimensions mm	Passage mm	Colour	Accessories	UM	€
<b>4000137</b>	243 x 606	157 x 525	WHITE		PCS	
<b>4000237</b>	243 x 606	157 x 525	GREY		PCS	
<b>0343300</b>				Lock	PCS	

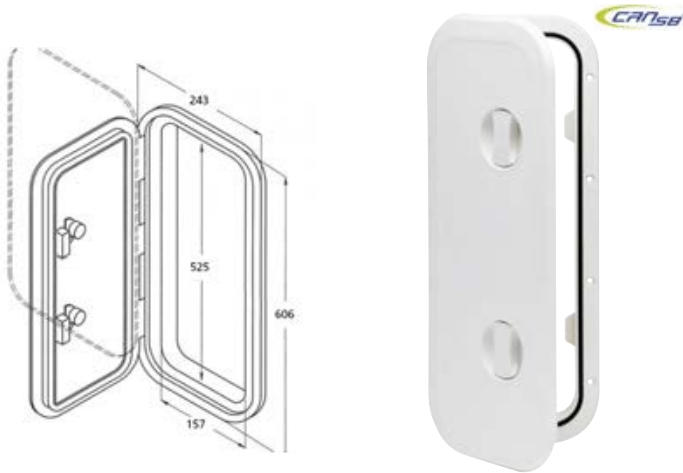

**DC XL Step-on Hatch**

Honeycomb reinforced Plastic 180° opening walkable watertight hatch. Hatch with double opening system: classic and extractable. The extractable system allows to open the hatch in narrow spaces. Deck or bulkhead mount.

Code	Dimensions mm	Passage mm	Colour	Accessories	UM	€
<b>4000136</b>	357 x 606	274 x 523	WHITE		PCS	
<b>4000236</b>	357 x 606	274 x 523	GREY		PCS	
<b>0343300</b>				Lock	PCS	

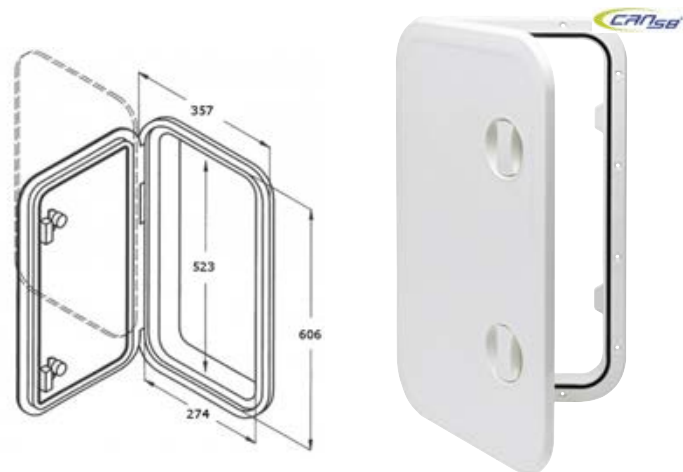

- HEAVY DUTY STEP-ON HATCHES -

**HMG 1Handle Step-on Hatches**

Almost indestructible Saralon Polypropylene resin hatch doors. Walkable, shock-proof, cannot be harmed by UV rays, solvents and fuels. 180° opening with Stainless Steel hinges. In-laid gasket ensures perfect watertight seal. Deck or bulkhead mount. CE certified.

Code	Dimensions mm	Deck Cutout mm	UM	€
<b>4002601</b>	280 x 381	235 x 337	PCS	
<b>4002603</b>	331 x 432	286 x 388	PCS	
<b>4002604</b>	407 x 458	362 x 413	PCS	



**HMG 2Handle Step-on Hatches**

Almost indestructible Saralon Polypropylene resin hatch doors. Walkable, shock-proof, cannot be harmed by UV rays, solvents and fuels. 180° opening with Stainless Steel hinges. In-laid gasket ensures perfect watertight seal. Deck or bulkhead mount. CE certified.

Code	Dimensions mm	Deck Cutout mm	UM	€
<b>4002354</b>	425 x 540	365 x 470	PCS	
<b>4002362</b>	331 x 585	286 x 540	PCS	
<b>4002364</b>	331 x 762	286 x 718	PCS	



**Small Aluminum Step-on Hatch**

Anodized Aluminum walkable small hatch. Extremely resistant, shock-proof and well finished.

Code	Dimensions mm	Cutout mm	Colour	UM	€
<b>4003027</b>	270 x 370	206 x 306	WHITE	PCS	
<b>4003028</b>	270 x 370	206 x 306	GREY	PCS	

**Large Aluminum Step-on Hatch**

Anodized Aluminum walkable large hatch. Extremely resistant, shock-proof and well finished.

Code	Dimensions mm	Cutout mm	Colour	UM	€
<b>4003051</b>	460 x 510	393 x 446	WHITE	PCS	
<b>4003052</b>	460 x 510	393 x 446	GREY	PCS	

**Long Aluminum Step-on Hatch**

Anodized Aluminum walkable long hatch. Extremely resistant, shock-proof and well finished.

Code	Dimensions mm	Cutout mm	Colour	UM	€
<b>4003060</b>	350 x 600	286 x 537	WHITE	PCS	
<b>4003061</b>	350 x 600	286 x 537	GREY	PCS	



**Small DC Step-on Box Hatch**

Honeycomb reinforced Plastic 180° opening walkable hatch with box. Hatch with double opening system: classic and extractable. The extractable system allows to open the hatch in narrow spaces.

Code	Dimensions mm	Passage mm	Depth mm	Accessories	UM	€
<b>4000429</b>	270 x 373	190 x 290	160		PCS	
<b>0343300</b>				Lock	PCS	

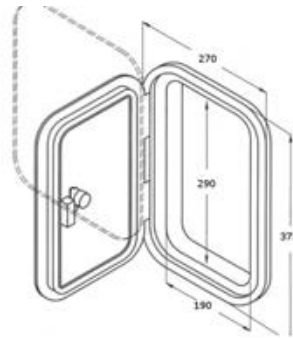

**Small Square DC Step-on Box Hatch**

Honeycomb reinforced Plastic 180° opening walkable hatch with box. Hatch with double opening system: classic and extractable. The extractable system allows to open the hatch in narrow spaces.

Code	Dimensions mm	Passage mm	Depth mm	Accessories	UM	€
<b>4000442</b>	373 x 373	290 x 290	250		PCS	
<b>0343300</b>				Lock	PCS	

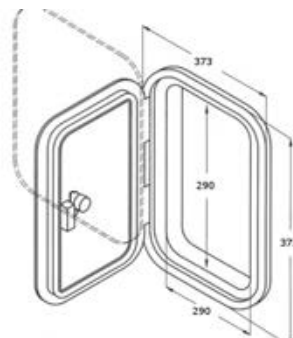

**Big DC Step-on Box Hatch**

Honeycomb reinforced Plastic 180° opening walkable hatch with box. Hatch with double opening system: classic and extractable. The extractable system allows to open the hatch in narrow spaces.

Code	Dimensions mm	Passage mm	Depth mm	Accessories	UM	€
<b>4000436</b>	357 x 606	274 x 523	320		PCS	
<b>0343300</b>				Lock	PCS	

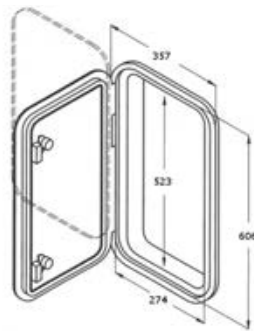

**Big Square DC Step-on Box Hatch**

Honeycomb reinforced Plastic 180° opening walkable hatch with box. Hatch with double opening system: classic and extractable. The extractable system allows to open the hatch in narrow spaces.

Code	Dimensions mm	Passage mm	Depth mm	Accessories	UM	€
<b>4000450</b>	458 x 513	374 x 430	330		PCS	
<b>0343300</b>				Lock	PCS	

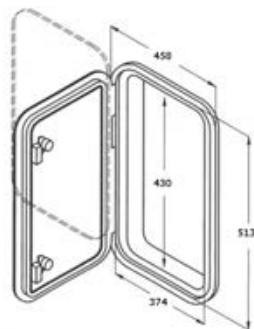



**Bulkhead Mount ABS Hatches**

Bulkhead vertical mount inspection and utility hatch.

Code	Dimensions mm	Deck Cutout mm	Accessories	UM	€
4000102	306 x 356	246 x 296		PCS	
4000104	380 x 380	295 x 295		PCS	
0343316			Locking System	PCS	



**IPS Inspection Deck Plate**

Almost indistructible Saralon (Polypropylene resin) inspection deck plate. Walkable, shock-proof, cannot be harmed by UV rays, solvents and fuels. Handle closing.

Code	External Dim mm	Inner Dim mm	Deck Cutout mm	UM	€
4002114	229 x 356	172 x 295	183 x 310	PCS	



**JB3 Watertight Access Deck Plates**

Almost indistructible Polypropylene Resin waterproof inspection deck plate. Walkable and shock-proof, cannot be harmed by UV rays, solvents and fuels. Handle closing.

Code	External ø mm	Internal ø mm	UM	€
4002120	202	132	PCS	
4002126	252	182	PCS	



**CN1 Watertight Deck Hatches**

Handle locking ABS Plastic waterproof hatch.

Code	External ø mm	Internal ø mm	UM	€
4000019	265	185	PCS	
4000022	315	230	PCS	



**IPS Watertight Access Deck Plates**

Almost indistructible Saralon Polypropylene resin access deck plates. Shock-proof, cannot be harmed by UV rays, solvents and fuels. Watertight pressure closing.

Code	External ø mm	Internal ø mm	UM	€
4002104	153	96	PCS	
4002106	203	146	PCS	
4002108	254	197	PCS	



LADDERS GANGWAYS/STAFFS SEATS/PORT LIGHTS AIR VENTS

3

**BW2 Inspection Deck Plate**

Screw-in waterproof Plastic deck plate.

Code	External ø mm	Internal ø mm	Colour	UM	€
4000004	143	104	WHITE	PCS	
4000005	143	104	BLACK	PCS	
4000008	205	155	WHITE	PCS	
4000009	205	155	BLACK	PCS	

**BW Vision Inspection Deck Plate**

Screw-in waterproof Plastic deck plate with O-Ring seal gasket. Transparent lid for fast and easy visual inspection.

Code	External ø mm	Internal ø mm	UM	€
4000080	143	104	PCS	
4000081	170	130	PCS	
4000082	205	155	PCS	

**BW1 Inspection Deck Plate**

Screw-in waterproof Plastic deck plate with O-Ring seal gasket.

Code	External ø mm	Internal ø mm	Colour	UM	€
4000010	140	104	WHITE	PCS	
4000011	140	104	BLACK	PCS	
4000013	165	129	WHITE	PCS	
4000014	165	129	BLACK	PCS	
4000015	190	154	WHITE	PCS	
4000016	190	154	BLACK	PCS	

**CN1 Watertight Deck Hatches**

Screw-in closing Plastic watertight deck hatch.

Code	External ø mm	Internal ø mm	Colour	UM	€
4000051	160	110	WHITE	PCS	
4000052	160	110	GREY	PCS	
4000053	160	110	BLACK	PCS	
4000055	185	130	WHITE	PCS	
4000056	185	130	GREY	PCS	
4000057	185	130	BLACK	PCS	
4000059	210	160	WHITE	PCS	
4000060	210	160	GREY	PCS	
4000061	210	160	BLACK	PCS	

**SeaPort Inspection Deck Plate**

UV resistant ABS Plastic waterproof hatch. Easy screw-in closing with rubber seal.

Code	External ø mm	Internal ø mm	Cutout ø mm	UM	€
4000083	143	101	113	PCS	
4000084	198	151	162	PCS	
4000085	250	180	197	PCS	

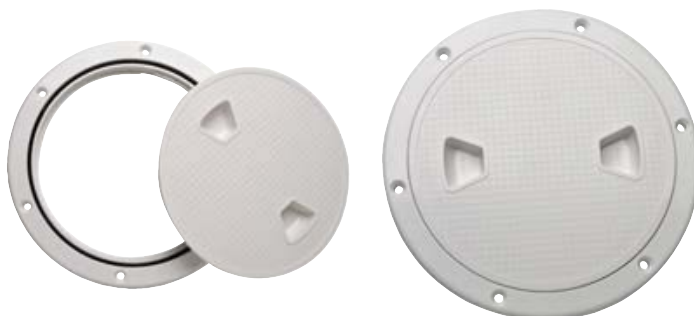

**Radio-VHF Hatch**

Waterproof hatch for radio or VHF.

Code	Key	UM	€
4000017	No	PCS	
4000018	Yes	PCS	

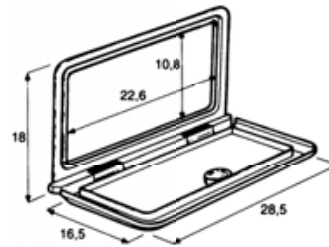
**Radio-VHF Box Hatch**

Waterproof recessed storage locker for radio or VHF.

Code	Key	UM	€
4000417	No	PCS	
4000418	Yes	PCS	

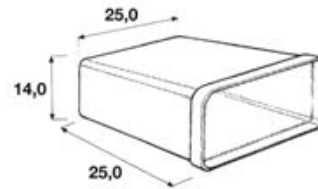
**Drawers Box Hatch**

White reinforced Plastic watertight hatch with drawers.

Code	Ref	Accessories	UM	€
4000528	Hatch		PCS	
0343308		Lock	PCS	

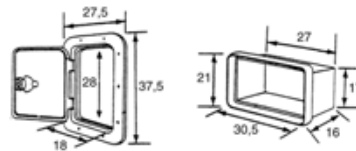
**Large Storage Pocket**

Plastic recessed large storage case.

Code	mm	UM	€
4010042	540 x 240 x 125	PCS	

**Midi Storage Pocket**

Plastic recessed midi storage case.

Code	mm	UM	€
4010041	420 x 170 x 100	PCS	

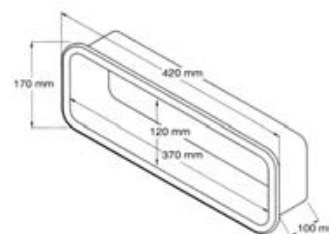
**Mini Flush Recessed Box**

Plastic recessed mini storage case, also used as a flush handle.

Code	mm	UM	€
4010000	85 x 175	PCS	



**Cone Recessed Box**

Shower or deckfill conical Plastic case.

Code	UM	€
4010018	PCS	

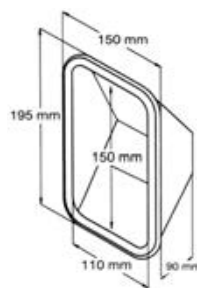

**Short Recessed Box**

Shower or battery switch built-in Plastic case.

Code	Door	Frame mm	Depth mm	UM	€
4010020	No	160 x 235	100	PCS	
4010024	Yes	175 x 245	100	PCS	



**Compact Recessed Box**

Shower, battery switch and circuit panel built-in Plastic case.

Code	Door	Frame mm	Depth mm	UM	€
4010022	No	155 x 200	80	PCS	
4010023	Yes	165 x 210	80	PCS	



**Standard Recessed Box**

Standard built-in Plastic case. May contain a 1 Kg fire extinguisher.

Code	Door	Frame mm	Depth mm	UM	€
4010003	No	170 x 420	110	PCS	
4010025	Yes	180 x 430	110	PCS	



**Long Recessed Box**

Long built-in Plastic case. May contain a 2 Kg fire extinguisher.

Code	Door	Frame mm	Depth mm	UM	€
4010004	No	200 x 470	130	PCS	
4010026	Yes	220 x 485	130	PCS	



**Fire Extinguisher Recessed Box**

Covered 1 kg fire extinguisher built-in ABS Plastic box with clear door.

Code	Frame mm	Depth mm	UM	€
4010035	180 x 430	110	PCS	



**OC Straight Vent**

Chromed Brass thru-hull tank vent. S/Steel mesh wire screening.

Code	H mm	Pipe ø mm	UM	€
<b>1710000</b>	68	16	PCS	



**Stainless Steel Straight Vent**

Stainless Steel thru-hull tank vent. S/Steel mesh wire screening.

Code	H mm	Pipe ø mm	UM	€
<b>1709900</b>	76	16	PCS	



**OC R.I.Na. Straight Vent**

Chromed Brass thru-hull tank vent. S/Steel mesh wire screening. Meets R.I.Na. regulations.

Code	Pipe ø mm	UM	€
<b>1710001</b>	16	PCS	
<b>1710002</b>	20	PCS	



**Stainless Steel Straight Flush Vent**

Stainless Steel recessed tank vent.

Code	H mm	Pipe ø mm	Flange ø mm	Bulk >mm<	UM	€
<b>1709901</b>	76	16	35	15<>25	PCS	
<b>1709902</b>	76	16	35	5<>15	PCS	



**OC R.I.Na. Straight Flush Vent**

Chromed Brass recessed tank vent. Meets R.I.Na. regulations.

Code	H mm	Pipe ø mm	Flange ø mm	UM	€
<b>1710006</b>	68	16	35	PCS	
<b>1710007</b>	68	20	35	PCS	



**Stainless Steel Elbow 90° Vent**

Stainless Steel thru-hull 90° elbow tank vent. S/Steel mesh wire screening.

Code	H mm	Pipe ø mm	UM	€
<b>1709904</b>	88	16	PCS	



**OC R.I.Na. Elbow 90° Vent**

Chromed Brass thru-hull 90° elbow tank vent. S/Steel mesh wire screening. Meets R.I.Na. regulations.

Code	Pipe ø mm	Side	UM	€
<b>1710004</b>	16	Right	PCS	
<b>1710314</b>	16	Left	PCS	
<b>1710315</b>	20	Right	PCS	
<b>1710316</b>	20	Left	PCS	

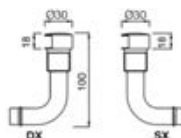

**Stainless Steel Elbow 90° Flush Vent**

Stainless Steel recessed 90° elbow tank vent.

Code	H mm	ø mm	Flange ø mm	Bulk >mm<	UM	€
<b>1709905</b>	88	16	35	15<>25	PCS	
<b>1709906</b>	88	16	35	5<>15	PCS	

**OC R.I.Na. Elbow 90° Flush Vent**

Chromed Brass recessed 90° elbow tank vent.

Meets R.I.Na. regulations.

Code	Pipe ø mm	ø1 mm	ø2 mm	Side	UM	€
<b>1710008</b>	16	32	40	Right	PCS	
<b>1710318</b>	16	32	40	Left	PCS	
<b>1710320</b>	20	40	50	Right	PCS	
<b>1710321</b>	20	40	50	Left	PCS	

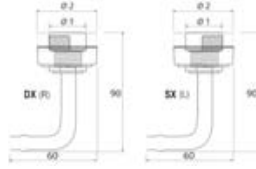
**Plastic Straight Round Vent**

Plastic thru-hull round head tank vent.

Code	H mm	ø mm	UM	€
<b>1710201</b>	83	16	PCS	

**Plastic Elbow 90° Round Vent**

Plastic thru-hull 90° elbow round head tank vent.

Code	H mm	ø mm	UM	€
<b>1710204</b>	73	16	PCS	

**Plastic Straight Oval Vent**

Plastic thru-hull oval head tank vent.

Code	H mm	ø mm	UM	€
<b>1710301</b>	83	16	PCS	

**Plastic Elbow 90° Oval Vent**

Plastic thru-hull 90° elbow oval head tank vent.

Code	H mm	ø mm	UM	€
<b>1710305</b>	73	16	PCS	

**STS Clam Shell Vents**

Stainless Steel clam shell, for vents or drainage cover.

Code	mm	UM	€
<b>1704004</b>	44 x 41 x H12	PCS	
<b>1704005</b>	54 x 57 x H16	PCS	
<b>1704006</b>	93 x 87 x H25	PCS	

**PLA Clam Shell Vents**

Plastic clam shell, for vents or drainage cover.

Code	mm	UM	€
<b>1704008</b>	50 x 55 x H12	PCS	



## AIR VENTS

## PLASTIC VENTS

**Plastic Louvered M1 Vent**

Plastic air vent.

Code	Dim mm	Colour	UM	€
<b>1701006</b>	85 x 85	BLACK	PCS	
<b>1701007</b>	85 x 85	WHITE	PCS	

**Plastic Vent with Connection**

Recessed Plastic air vent with 70 and 75 mm pipe to air hose connection.

Code	Recess ø mm	UM	€
<b>1702056</b>	70	PCS	
<b>1702057</b>	75	PCS	

**Plastic Louvered M2 Vent**

Plastic air vent.

Code	mm	Colour	UM	€
<b>1701008</b>	140 x 124	BLACK	PCS	
<b>1701009</b>	140 x 124	WHITE	PCS	

**Big Plastic Louvered Vent**

Big Plastic air vent.

Code	L mm	H mm	Colour	UM	€
<b>1702050</b>	260	125	BLACK	PCS	
<b>1702051</b>	260	125	WHITE	PCS	

**Plastic Short Recessed Louvered Vent**

Recessed short Plastic air vent.

Code	L mm	H mm	Colour	UM	€
<b>1702030</b>	335	120	BLACK	PCS	
<b>1702031</b>	335	120	WHITE	PCS	

**Plastic Long Recessed Louvered Vent**

Recessed long Plastic air vent.

Code	Dim mm	Recess Dim mm	Colour	UM	€
<b>1702045</b>	460 x 87	405 x 57	BLACK	PCS	
<b>1702046</b>	460 x 87	405 x 57	WHITE	PCS	

**Plastic Trap Recessed Louvered Vent**

Recessed Plastic air vent with water trap.

Code	L mm	H mm	UM	€
<b>1702042</b>	420	120	PCS	



**S/S Adjustable Louvered Round Vent**

Stainless Steel round grid air vent or with adjustable closing system.

Code	Ref	ø mm	UM	€
<b>1703000</b>	Adjustable	125	PCS	
<b>1703010</b>	Grid	125	PCS	

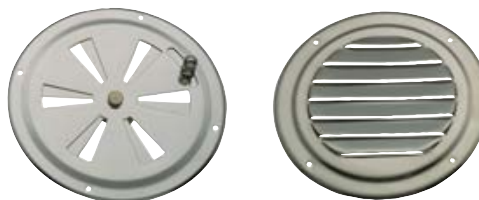
**S/S Mini Louvered Vent**

Mini Stainless Steel air vent.

Code	mm	UM	€
<b>1700001</b>	127 x H67	PCS	
<b>1700002</b>	127 x H115	PCS	

**S/S High Louvered Vent**

High Stainless Steel air vent.

Code	mm	UM	€
<b>1700003</b>	127 x H228	PCS	

**S/S Wide Louvered Vent**

Large Stainless Steel air vent.

Code	mm	UM	€
<b>1700004</b>	230 x H116	PCS	

**S/S Compact Recessed Vent**

Stainless Steel compact recessed air vents.

Code	Dim mm	UM	€
<b>1702002</b>	210 x 110	PCS	
<b>1702006</b>	325 x 110	PCS	

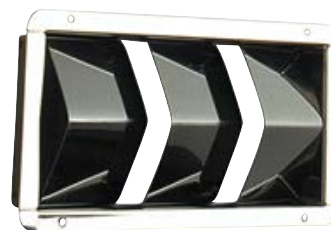
**S/S Narrow Recessed Vent**

Stainless Steel narrow recessed air vent.

Code	External Dim mm	Recess Dim mm	UM	€
<b>1702010</b>	460 x 75	440 x 54	PCS	
<b>1702012</b>	550 x 110	540 x 87	PCS	

**S/S Vetus SSV Recessed Vent**

316 Stainless Steel Vetus SSV recessed air vent with Anodized Aluminum grids.

Code	External Dim mm	Recess Dim mm	UM	€
<b>1702116</b>	660 x 159	640 x 139	PCS	
<b>1702119</b>	750 x 198	730 x 178	PCS	
<b>1702120</b>	890 x 198	870 x 178	PCS	





**Low Profile Cowl Vents**

Low profile flexible PVC cowl ventilators with base and threaded cap.

Code	H mm	Neck ø mm	UM	€
<b>1706007</b>	90	70	PCS	
<b>1706010</b>	150	100	PCS	

**High Profile Cowl Vents**

High profile flexible PVC cowl ventilators with base and threaded cap.

Code	H mm	Neck ø mm	UM	€
<b>1706107</b>	240	70	PCS	
<b>1706110</b>	240	100	PCS	

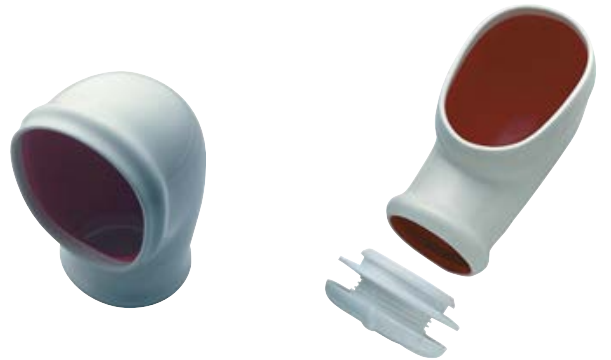
**Low Profile Silicon Cowl Vents**

Low profile Silicon Rubber cowl ventilators with flange and ring made of reinforced Plastic. They can revolve and are removable. Resistant to temperature, UV rays, dirt and discolouration. The optional Dorade Box endowed with closing handle and bug screen drains off any water entering the ventilator.

Code	H mm	Inner ø mm	Accessories	UM	€
<b>1706207</b>	111	75		PCS	
<b>1706208</b>	205	75		PCS	
<b>1706218</b>			Dorade Box	PCS	



DAVIS

**High Profile Silicon Cowl Vents**

High profile Silicon Rubber cowl ventilators with flange and ring made of reinforced plastic. They can revolve and are removable. Resistant to temperature, UV rays, dirt and discolouration. The optional Dorade Box endowed with closing handle and bug screen drains off any water entering the ventilator.

Code	H mm	Inner ø mm	Accessories	UM	€
<b>1706210</b>	250	100		PCS	
<b>1706212</b>	300	125		PCS	
<b>1706220</b>			ø 100 Dorade Box	PCS	
<b>1706222</b>			ø 125 Dorade Box	PCS	



DAVIS

**Universal Air Funnel Awnings**

Folding frame with waterproof fabric sail cockpit awning for hatches up to 1 meter wide. Perfect to aerate moored boats.

Code	UM	€
<b>1706300</b>	PCS	



DAVIS

**S/S Stamped Vent**

Large ventilation port Stainless Steel stamped air vent.

Code	mm	UM	€
<b>1701031</b>	130 x 120	PCS	

**S/S Extra Vent**

Mirror Polished Stainless Steel air vent with big air inlet and bracket for ø 75 mm air duct hose.

Code	mm	UM	€
<b>1701030</b>	150 x 120	PCS	

**Mushroom PL Deck Vent**

Mushroom Plastic deck vent with internal adjustment.

Code	Base ø mm	Neck ø mm	UM	€
<b>1703515</b>	150	100	PCS	

**Mushroom Stainless Steel Deck Vent**

Mushroom Stainless Steel deck vent with internal adjustment and bug screen.

Code	Base mm	Neck mm	H mm	UM	€
<b>1703011</b>	117	85	31<>45	PCS	
<b>1703015</b>	152	122	31<>43	PCS	
<b>1703017</b>	185	147	36<>53	PCS	

**Deck ST Vent**

Stainless Steel translucent passive vent with Polycarbonate transparent top.

Code	Base ø mm	Inner ø mm	H mm	UM	€
<b>1703220</b>	230	95	30	PCS	

**Air Deck SH Vent**

Deck passive aerator with inside lock. Stainless Steel cover and Plastic base.

Code	Base ø mm	Neck ø mm	H mm	UM	€
<b>1703019</b>	200	95	57	PCS	

**Deck SS Vent**

Stainless Steel body standard cabine ventilator or with CE All class certification. Can be completed with a 12 or 24V electric deck extractor (1703022). CE model can be closed where necessary, with bug screen included.

Code	Ref	Base ø mm	Inner ø mm	H mm	UM	€
<b>1703020</b>	Standard	200	72	30	PCS	
<b>1703021</b>	CE	200	85	30	PCS	



**Solara SS Vent**

Stainless Steel case waterproof solar powered vent. Two types of blades (intake and exhaust) are provided with each vent.

Code	Base ø mm	Neck mm	H mm	UM	€
<b>1703040</b>	220	120	35	PCS	



MTM

**Day & Night Solara SS Vent**

Stainless Steel case waterproof solar powered vent. Two types of blades (intake and exhaust) are provided with each vent. In the Day & Night mode it works also during night-time thanks to the rechargeable solar battery.

Code	Base ø mm	Neck mm	H mm	UM	€
<b>1703041</b>	220	120	35	PCS	



MTM

**Deck Extractor**

12 or 24V electric deck extractor.

Code	V	Base ø mm	Inner ø mm	H mm	UM	€
<b>1703022</b>	12	130	70-100	60	PCS	
<b>1703024</b>	24	130	70-100	60	PCS	

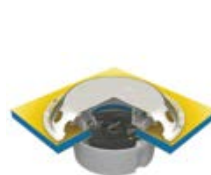

VETUS

**- ELECTRIC FANS AND EXTRACTORS -****Hella Turbo Fan**

Universal mount Hella Turbo Fan. It can be turned and pivoted in all directions or locked in a fixed position. Endowed with quiet operation motor with two speed switch, pre-wired with 14 cm cable. 150 mm diameter fan blades with protection guard. High air moving capacity with low power consumption 6,5 W.

Code	Dim mm	V	Colour	UM	€
<b>1711027</b>	188 x H195	12	BLACK	PCS	
<b>1711028</b>	188 x H195	12	WHITE	PCS	



Hella marine

**AA Oscillating Fan**

Top or wall mount oscillating fan.

Code	Diameter mm	V	UM	€
<b>1711020</b>	180	12	PCS	
<b>1711024</b>	180	24	PCS	

**Turbo In-Line 2T Blower**

Turbo in-line bilge blower for engine rooms, galleys and cabins. Amp draw 2,9A (12V).

Code	V	Intake ø mm	L mm	UM	€
<b>1710010</b>	12	75	130	PCS	
<b>1710012</b>	12	100	130	PCS	
<b>1710011</b>	24	100	130	PCS	



MTM QUALITY

**Turbo In-Line Attwood Blowers**

Turbo in-line waterproof blowers for engine rooms and cabins. Complete with 2 tie straps. Blowers designed to grant 25% more air flux than other blowers, using 40% less power. Nickel-plated motor with cap and sealed wiring for total corrosion protection.

Code	Ref	V	Intake ø mm	L mm	UM	€
<b>1710015</b>	Turbo 3000	12	75	130	PCS	
<b>1710017</b>	Turbo 4000	12	100	130	PCS	
<b>1710018</b>	Turbo 4000	24	100	130	PCS	



attwood

**Flanged Blowers**

High quality continuous duty flanged centrifugal blowers for engine rooms and bilges. Reinforced ABS case and waterproof motor. Wall flange mount. CE certified complying ISO 9097 Marine/ISO 8846/ISO 10133/EN 55014 standards and N.M.M.A USCG 183.410 rules.

Code	V	Capacity m3 Hour	H x W x L mm	Ports ø mm	UM	€
<b>1710013</b>	12	280	200 x 165 x 195	In:75 - Out: 72	PCS	
<b>1710024</b>	24	280	200 x 165 x 195	In:75 - Out: 72	PCS	



**Flanged Heavy Duty Blowers**

High quality continuous and Heavy Duty flanged centrifugal blowers for engine rooms and bilges. Reinforced ABS case and waterproof motor. Wall flanged mount. CE certified complying ISO 9097 Marine/ISO 8846/ISO 10133/EN 55014 standards and N.M.M.A USCG 183.410 rules.

Code	V	Capacity m3 Hour	H x W x L mm	Ports ø mm	UM	€
<b>1710055</b>	12	550	290 x 257 x 150	In:110 - Out:103	PCS	
<b>1710056</b>	24	550	290 x 257 x 150	In:110 - Out:103	PCS	
<b>1710057</b>	12	750	290 x 257 x 150	In:150 - Out:103	PCS	
<b>1710058</b>	24	750	290 x 257 x 150	In:150 - Out:103	PCS	
<b>1710061</b>	24	1000	290 x 257 x 180	In:150 - Out:103	PCS	



**Bracket Blowers**

High quality continuous duty bracket mount centrifugal blowers for engine rooms and bilges. Reinforced ABS case and waterproof motor. Bracket base mount. CE certified complying ISO 9097 Marine/ISO 8846/ISO 10133/EN 55014 standards and N.M.M.A USCG 183.410 rules.

Code	V	Capacity m3 Hour	H x W x L mm	Ports ø mm	UM	€
<b>1710075</b>	12	550	290 x 257 x 150	In:100 - Out:110	PCS	
<b>1710076</b>	24	550	290 x 257 x 150	In:100 - Out:110	PCS	
<b>1710077</b>	12	750	290 x 257 x 150	In:150 - Out:103	PCS	
<b>1710078</b>	24	750	290 x 257 x 150	In:150 - Out:103	PCS	
<b>1710081</b>	24	1000	290 x 257 x 180	In:150 - Out:103	PCS	



**Ocean In-Line Flow Blowers**

Large capacity In-line electric blowers with high efficiency silent fan designed with aerospace technology according to ISO8846 EN55014. For intermittent use or for Heavy Duty continuous use.

Code	Use	V	Capacity m3 Hour	Intake ø mm	L mm	UM	€
<b>1710083</b>	Intermittent	12	750	178	160	PCS	
<b>1710084</b>	Intermittent	24	750	178	160	PCS	
<b>1710087</b>	HD Continuous	12	1000	178	160	PCS	
<b>1710088</b>	HD Continuous	24	1000	178	160	PCS	

**New**



**VE Helicoidal Blowers**

Bi-directional flow in-line helicoidal blowers with permanent magnet electric motor for continuous use. Varnished Steel drum with dynamically and statically balanced Polypropylene fan.

Code	V	Capacity m3 Hour	B mm	C mm	D mm	G mm	UM	€
<b>1710152</b>	24	1800	260	200	300	315	PCS	
<b>1710159</b>	24	3000	360	215	300	425	PCS	

