

8

HARDWARE SAILING /
COVERS ROPES /
FLAGS COVERINGS

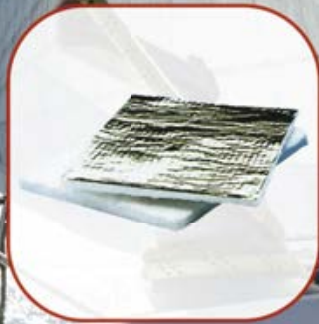

M T M

Stamped D Shackle

316 Stainless Steel stamped Dee shackle.

Code	D mm	L mm	W mm	UM	€
0121515	4	15	10	PCS	
0121517	5	17	12	PCS	
0121524	4	20	10	PCS	
0121525	5	24	16	PCS	
0121526	5	25	13.5	PCS	
0121542	6	23	16	PCS	



D Shackle

316 Stainless Steel stamped Dee Shackle.

Code	D mm	L mm	W mm	UM	€
0121540	5	36	16	PCS	
0121543	6	40	14	PCS	
0121544	8	42	18	PCS	



Stamped Ring D Shackle

316 Stainless Steel stamped Dee shackle with ring.

Code	D mm	L mm	W mm	UM	€
0121502	4	15	10	PCS	
0121503	4	24	12	PCS	
0121504	5	17	12	PCS	
0121505	5	25	16	PCS	
0121506	5	37	22	PCS	



Stamped Twisted T Shackle

316 Stainless Steel stamped Twisted shackle.

Code	D mm	L mm	W mm	UM	€
0121552	5	22	12	PCS	
0121555	5	33	12	PCS	
0121557	6	36	14	PCS	



HS Narrow D Shackle

316 Stainless Steel stamped narrow HS Dee shackle. Tested working load (WL). The breaking load (BL) is 4 times the working load.

Code	D mm	L mm	W mm	WL Kg	UM	€
0121614	4	16	8	150	PCS	
0121615	5	20	8	250	PCS	
0121616	5	22	12	275	PCS	
0121617	6	25	13	325	PCS	



Stamped HS Wide D Shackle

316 Stainless Steel stamped wide HS Dee shackle. Tested working load (WL). The breaking load (BL) is 4 times the working load.

Code	D mm	L mm	W mm	WL Kg	UM	€
0121624	4	20	10	150	PCS	
0121625	5	20	11	250	PCS	
0121626	5	22	15	275	PCS	
0121627	6	25	17	325	PCS	



Stamped HS Screw D Shackle

316 Stainless Steel stamped HS Dee shackle with screw. Tested working load (WL). The breaking load (BL) is 4 times the working load.

Code	D mm	L mm	W mm	WL Kg	UM	€
0121664	4	16	10	125	PCS	
0121665	5	20	10	250	PCS	
0121666	6	25	15	325	PCS	



Stamped HS Ring D Shackle

316 Stainless Steel stamped HS Dee shackle with extra ring. Tested working load (WL). The breaking load (BL) is 4 times the working load.

Code	D mm	L mm	W mm	WL Kg	UM	€
0121507	5	17	8	187	PCS	
0121508	5	21	9	187	PCS	
0121509	5	36	14	250	PCS	
0121510	5	36	18	250	PCS	



Key Pin Stamped D Shackle

316 Stainless Steel key pin stamped Dee shackle.

Code	D mm	L mm	W mm	UM	€
0121562	4	22	11	PCS	
0121563	5	36	15	PCS	
0121564	6	40	15	PCS	



Key Pin Stamped D Shackle B

316 Stainless Steel key pin stamped Dee shackle with bar.

Code	D mm	L mm	L1 mm	W mm	UM	€
0121573	5	21	12	15	PCS	
0121574	6	25	12	15	PCS	
0121575	8	26	12	20	PCS	



D Shackle

316 Stainless Steel Dee shackle.

Code	D mm	L mm	W mm	UM	€
0120004	4	16	8	PCS	
0120005	5	20	10	PCS	
0120006	6	24	12	PCS	
0120008	8	32	16	PCS	
0120010	10	40	20	PCS	
0120012	12	48	24	PCS	
0120014	14	56	28	PCS	
0120016	16	64	32	PCS	

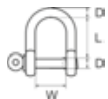

Captive Pin D Shackle

316 Stainless Steel captive pin Dee shackle.

Code	D mm	L mm	W mm	UM	€
0120104	4	16	8	PCS	
0120105	5	20	10	PCS	
0120106	6	24	12	PCS	
0120108	8	32	16	PCS	
0120110	10	40	20	PCS	

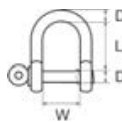

Bow Shackle

316 Stainless Steel Bow shackle.

Code	D mm	L mm	W mm	UM	€
0120505	5	16	9	PCS	
0120506	6	21	12	PCS	
0120508	8	27	16	PCS	
0120510	10	33	20	PCS	
0120512	12	40	23	PCS	
0120514	14	51	27	PCS	
0120516	16	60	32	PCS	



Captive Pin Bow Shackle

316 Stainless Steel captive pin Bow shackle.

Code	D mm	L mm	W mm	UM	€
0120545	5	25	10	PCS	
0120546	6	30	12	PCS	
0120548	8	40	16	PCS	
0120550	10	50	20	PCS	



Long D Shackle

316 Stainless Steel Long Dee shackle.

Code	D mm	L mm	W mm	UM	€
0120804	4	32	8	PCS	
0120805	5	40	10	PCS	
0120806	6	48	12	PCS	
0120808	8	64	16	PCS	
0120810	10	80	20	PCS	

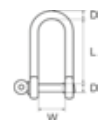

Captive Pin Long D Shackle

316 Stainless Steel captive pin Long Dee shackle.

Code	D mm	L mm	W mm	UM	€
0120704	4	32	8	PCS	
0120705	5	40	10	PCS	
0120706	6	48	12	PCS	
0120708	8	64	16	PCS	



Wide D Shackle

316 Stainless Steel Wide Dee shackle.

Code	D mm	L mm	W mm	UM	€
0121106	6	36	24	PCS	
0121108	8	36	28	PCS	
0121110	10	60	40	PCS	
0121112	12	72	48	PCS	



Twisted D Shackle

316 Stainless Steel Twisted Dee shackle.

Code	D mm	L mm	W mm	UM	€
0121005	5	30	10	PCS	
0121006	6	36	12	PCS	
0121008	8	40	16	PCS	
0121010	10	50	20	PCS	

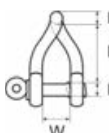

Key Pin Long D Shackle

316 Stainless Steel captive key pin Long Dee shackle.

Code	D mm	L mm	W mm	UM	€
0120905	5	40	13	PCS	
0120906	6	45	16	PCS	
0120908	8	64	22	PCS	



Key Pin Long D Shackle B

316 Stainless Steel captive key pin Long Dee Shackle with bar.

Code	D mm	L mm	W mm	UM	€
0120915	5	40	13	PCS	
0120916	6	45	16	PCS	
0120918	8	64	22	PCS	



Wichard D Shackle

Wichard 316 Stainless Steel self-locking Dee shackle. Breaking load (BL) tested and guaranteed.

Code	D mm	L mm	W mm	BL Kg	UM	€
3521004	4	13	8	700	PCS	
3521005	5	16	10	1000	PCS	
3521006	6	20	12	1600	PCS	
3521008	8	26	16	2700	PCS	
3521010	10	33	20	4300	PCS	
3521012	12	39	24	6000	PCS	

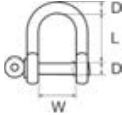

Wichard Captive Pin D Shackle

Wichard 316 Stainless Steel self-locking captive pin Dee shackle. Breaking load (BL) tested and guaranteed.

Code	D mm	L mm	W mm	BL Kg	UM	€
3521024	4	13	8	1000	PCS	
3521025	5	16	10	1500	PCS	
3521026	6	20	12	2200	PCS	
3521028	8	26	16	3600	PCS	
3521030	10	33	20	5200	PCS	

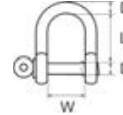

Wichard Bow Shackle

Wichard 316 Stainless Steel self-locking Anchor Bow shackle. Breaking load (BL) tested and guaranteed.

Code	D mm	L mm	W mm	BL Kg	UM	€
3521204	4	18	8	700	PCS	
3521205	5	23	10	1000	PCS	
3521206	6	28	12	1600	PCS	
3521208	8	37	16	2700	PCS	
3521210	10	47	20	4300	PCS	
3521212	12	55	24	6000	PCS	



Wichard Captive Pin Bow Shackle

Wichard 316 Stainless Steel self-locking captive pin Anchor Bow shackle. Breaking load (BL) tested and guaranteed.

Code	D mm	L mm	W mm	BL Kg	UM	€
3521224	4	18	8	1000	PCS	
3521225	5	23	10	1500	PCS	
3521226	6	28	12	2200	PCS	
3521228	8	37	16	3700	PCS	
3521230	10	47	20	5200	PCS	

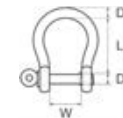

Wichard Long D Shackle

Wichard 316 Stainless Steel self-locking Long Dee shackle. Breaking load (BL) tested and guaranteed.

Code	D mm	L mm	W mm	BL Kg	UM	€
3521104	4	22	8	700	PCS	
3521105	5	29	10	1000	PCS	
3521106	6	33	12	1600	PCS	
3521108	8	45	16	2700	PCS	
3521110	10	55	20	4300	PCS	



Wichard Captive Pin Long D Shackle

Wichard 316 Stainless Steel self-locking captive pin Long Dee shackle. Breaking load (BL) tested and guaranteed.

Code	D mm	L mm	W mm	BL Kg	UM	€
3521124	4	31	8	1000	PCS	
3521125	5	39	10	1500	PCS	
3521126	6	46	12	2200	PCS	
3521128	8	62	16	3600	PCS	



Wichard Twisted T Shackle

Wichard 316 Stainless Steel self-locking Twisted shackle. Breaking load (BL) tested and guaranteed.

Code	D mm	L mm	W mm	BL Kg	UM	€
3521305	5	26	10	1100	PCS	
3521306	6	30	12	1500	PCS	
3521308	8	40	16	3000	PCS	

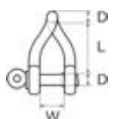

Wichard Captive Pin Twisted T Shackle

Wichard 316 Stainless Steel self-locking captive pin Twisted shackle. Breaking load (BL) tested and guaranteed.

Code	D mm	L mm	W mm	BL Kg	UM	€
3521325	5	38	10	1500	PCS	
3521326	6	44	12	2100	PCS	
3521328	8	59	16	3700	PCS	

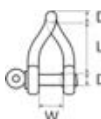

HARDWARE SAILING/COVERS ROPES/FLAGS COVERINGS

MTM D Shackle

High quality 316 Stainless Steel Dee Shackle supplied on presentation card. Working Load (WL) tested and guaranteed. Breaking Load (BL) is 4 times Working Load.

Code	D mm	L mm	W mm	WL Kg	BL Kg	UM	€
0120005C	5	20	10	230	920	PCS	
0120006C	6	24	12	330	1320	PCS	
0120008C	8	32	16	600	2400	PCS	
0120010C	10	40	20	930	3720	PCS	
0120012C	12	48	24	1400	5600	PCS	
0120014C	14	56	28	1800	7200	PCS	

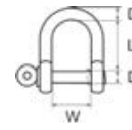

MTM Bow Shackle

High quality 316 Stainless Steel Bow Shackle supplied on presentation card. Working Load (WL) tested and guaranteed. Breaking Load (BL) is 4 times Working Load.

Code	D mm	L mm	W mm	WL Kg	BL Kg	UM	€
0120506C	6	21	12	330	1320	PCS	
0120508C	8	27	16	590	2370	PCS	
0120510C	10	33	20	930	3720	PCS	
0120512C	12	40	23	1370	5490	PCS	
0120514C	14	51	27	1800	7200	PCS	
0120516C	16	60	32	2440	9760	PCS	

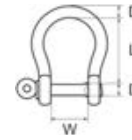

MTM Long D Shackle

High quality 316 Stainless Steel Long Dee Shackle supplied on presentation card. Working Load (WL) tested and guaranteed. Breaking Load (BL) is 4 times Working Load.

Code	D mm	L mm	W mm	WL Kg	BL Kg	UM	€
0120805C	5	40	10	230	920	PCS	
0120806C	6	48	12	330	1320	PCS	
0120808C	8	64	16	600	2400	PCS	
0120810C	10	80	20	930	3720	PCS	

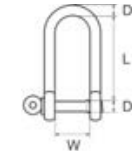

MTM Twisted D Shackle

High quality 316 Stainless Steel Twisted Dee Shackle supplied on presentation card. Working Load (WL) tested and guaranteed. Breaking Load (BL) is 4 times Working Load.

Code	D mm	L mm	W mm	WL Kg	BL Kg	UM	€
0121005C	5	30	10	230	920	PCS	
0121006C	6	36	12	330	1320	PCS	
0121008C	8	40	16	600	2400	PCS	
0121010C	10	50	20	930	3720	PCS	

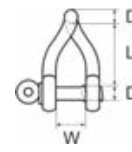

MTM Extra Wide D Shackle

High quality 316 Stainless Steel Wide Dee Shackle supplied on presentation card. Working Load (WL) tested and guaranteed. Breaking Load (BL) is 4 times Working Load.

Code	D mm	L mm	W mm	WL Kg	BL Kg	UM	€
0121106C	6	36	24	330	1320	PCS	
0121108C	8	36	28	600	2400	PCS	
0121110C	10	60	40	930	3720	PCS	
0121112C	12	72	48	1400	5600	PCS	

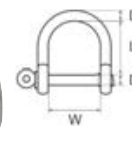

MTM Key Pin Long D Shackle

High quality captive key pin 316 Stainless Steel Long Dee Shackle supplied on presentation card. Working Load (WL) tested and guaranteed. Breaking Load (BL) is 4 times Working Load.

Code	D mm	L mm	W mm	WL Kg	BL Kg	UM	€
0120905C	5	40	13	230	920	PCS	
0120906C	6	45	16	330	1320	PCS	
0120908C	8	64	22	600	2400	PCS	

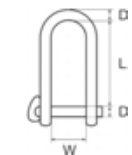

MTM Key Pin Long D Shackle B

High quality captive key pin 316 Stainless Steel Long Dee Shackle with bar supplied on presentation card. Working Load (WL) tested and guaranteed. Breaking Load (BL) is 4 times Working Load.

Code	D mm	L mm	W mm	WL Kg	BL Kg	UM	€
0120915C	5	40	13	230	920	PCS	
0120916C	6	45	16	330	1320	PCS	
0120918C	8	64	22	600	2400	PCS	

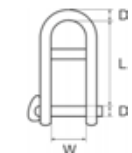

Standard Carabiner

316 Stainless Steel Standard Carabiner.

Code	D mm	L mm	A mm	UM	€
0211150	5	50	8	PCS	
0211160	6	60	9	PCS	
0211170	7	70	9	PCS	
0211180	8	80	10	PCS	
0211110	10	100	12	PCS	
0211112	11	120	16	PCS	
0211114	12	140	20	PCS	
0211116	13	160	26	PCS	

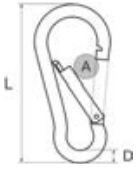

Standard Carabiner Eye

316 Stainless Steel Standard Carabiner with eye.

Code	D mm	L mm	A mm	O mm	UM	€
0211350	5	50	8	7.5	PCS	
0211360	6	60	9	9	PCS	
0211370	7	70	9	10	PCS	
0211380	8	80	10	11.5	PCS	
0211310	10	100	12	14	PCS	
0211312	11	120	16	16.5	PCS	
0211314	12	140	20	18	PCS	
0211316	13	160	26	20	PCS	



Side Carabiner

316 Stainless Steel Carabiner with wide side opening. It prevents ropes from tangling.

Code	D mm	L mm	A mm	UM	€
0211791	8	80	22	PCS	
0211792	10	100	24	PCS	
0211793	11	120	26	PCS	



Wide Carabiner

316 Stainless Steel Carabiner with wide opening.

Code	D mm	L mm	A mm	UM	€
0211891	8	85	18	PCS	
0211892	10	100	19	PCS	
0211893	11	125	26	PCS	

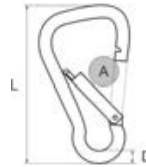

Wide Lock Carabiner

316 Stainless Steel Carabiner with wide opening and screw lock.

Code	D mm	L mm	A mm	UM	€
0211860	6	60	10	PCS	
0211880	8	80	14	PCS	
0211810	10	100	20	PCS	
0211812	11	120	24	PCS	



Wide Lock Carabiner Eye

316 Stainless Steel Carabiner with wide opening, screw lock and eye.

Code	D mm	L mm	A mm	O mm	UM	€
0212060	6	60	10	9	PCS	
0212080	8	80	14	11	PCS	
0212010	10	100	20	14	PCS	
0212012	11	120	24	18	PCS	



MTM Standard Carabiner

High quality 316 Stainless Steel Standard Carabiner supplied on presentation card. Working Load (WL) tested and guaranteed. Breaking Load (BL) is 4 times Working Load.



Code	D mm	L mm	A mm	WL Kg	BL Kg	UM	€
0211150C	5	50	8	90	360	PCS	
0211160C	6	60	9	130	520	PCS	
0211180C	8	80	10	180	720	PCS	
0211110C	10	100	12	280	1120	PCS	



MTM Standard Carabiner Eye

High quality 316 Stainless Steel Standard Carabiner with eye supplied on presentation card. Working Load (WL) tested and guaranteed. Breaking Load (BL) is 4 times Working Load.



Code	D mm	L mm	A mm	O mm	WL Kg	BL Kg	UM	€
0211350C	5	50	8	7.5	90	360	PCS	
0211360C	6	60	9	9	130	520	PCS	
0211380C	8	80	10	11.5	180	720	PCS	
0211310C	10	100	12	14	280	1120	PCS	



Swivel Eye Standard Snap

316 Stainless Steel swiveling eye snap.

Code	L mm	O mm	UM	€
0211565	68	13	PCS	
0211585	85	18	PCS	

**Swivel Standard Eye Bolt Snap**

316 Stainless Steel snap hook with swivel eye. Piston pin opening.

Code	L mm	O mm	UM	€
0211506	64	10	PCS	
0211508	80	13	PCS	

**Swivel Square Eye Bolt Snap**

316 Stainless Steel bolt snap hook with swivel belt loop.

Code	L mm	O mm	UM	€
0211516	61	13	PCS	
0211518	81	21	PCS	

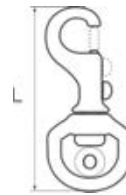
**Fixed Eye Snap**

316 Stainless Steel fixed eye snap.

Code	L mm	O mm	UM	€
0211453	53	10	PCS	
0211473	73	16	PCS	

**Belt Snap**

316 Stainless Steel snap with belt loop.

Code	A mm	C mm	UM	€
0211450	48	25	PCS	

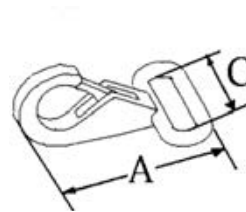
**Security Spring Hook Snap**

Security spring hook snap with belt/line eyelet for sailboats safety harnesses and bosun's wraps. Rugged 316 Stainless Steel construction.

Code	D mm	L mm	A mm	O mm	UM	€
0212580	8	80	14	16	PCS	
0212510	10	100	20	20	PCS	

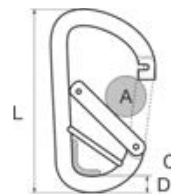
**Flat Security Spring Hook Snap**

Security spring hook snap with belt/line eyelet for sailboats safety harnesses and bosun's wraps. With lock lever and composite protection. Rugged 316 Stainless Steel construction.

Code	L mm	A mm	O mm	UM	€
0212611	100	16	24	PCS	



Closed End Snap Hook

Wichard 316 Forged Stainless Steel closed end jib snap hook. Breaking load (BL) tested and guaranteed.

Code	L mm	O mm	BL Kg	UM	€
3522350	50	8	300	PCS	
3522375	75	10	700	PCS	

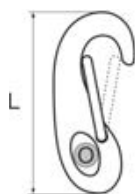
**Fixed Eye Snap Shackle**

Wichard 316 Forged Stainless Steel fixed eye spi snap shackle. Breaking load (BL) tested and guaranteed.

Code	L mm	O mm	BL Kg	UM	€
3522550	50	10	2000	PCS	
3522570	70	13	3500	PCS	

**Swivel Eye Snap Shackle**

Wichard 316 Forged Stainless Steel swivel eye spi snap shackle. Breaking load (BL) tested and guaranteed.

Code	L mm	O mm	BL Kg	UM	€
3522670	70	11	2000	PCS	
3522690	90	14	3850	PCS	

**Swivel Eye Snap Shackle L**

Wichard 316 Forged Stainless Steel swivel eye spi snap shackle. Breaking load (BL) tested and guaranteed.

Code	L mm	O mm	BL Kg	UM	€
3522691	80	19	2000	PCS	
3522692	105	26	3850	PCS	

**Clevis Pin Snap Shackle**

Wichard 316 Forged Stainless Steel swivel eye spi snap shackle with clevis pin. Breaking load (BL) tested and guaranteed.

Code	L mm	O mm	BL Kg	UM	€
3522770	70	12	1700	PCS	
3522790	90	12	3850	PCS	

**Swivel Eye Snap Shackle CL**

Wichard 316 Forged Stainless Steel swivel eye spi snap shackle. Breaking load (BL) tested and guaranteed.

Code	L mm	O mm	BL Kg	UM	€
3522970	70	11	1500	PCS	
3522980	80	12	2300	PCS	
3522990	90	13,5	3200	PCS	
3522991	110	16	4800	PCS	

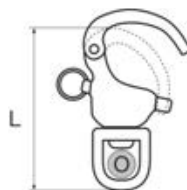
**Swivel Eye Snap Shackle CR**

Wichard 316 HR Forged Stainless Steel swivel eye spi snap shackle. Breaking load (BL) tested and guaranteed.

Code	L mm	O mm	BL Kg	UM	€
3523090	85	11	3600	PCS	
3523091	105	16	5000	PCS	



Open End Jib Snap Hook

316 Stainless Steel open end spring gate jib snap hook. Used to attach the jib onto the bow eye bolt. It is sewn on a belt or spliced on a line and then beated.

Code	L mm	O mm	UM	€
022252	52	8	PCS	
022265	65	10	PCS	



Closed End Jib Snap Hook

316 Stainless Steel closed end spring gate jib snap hook. Used to attach the jib onto the bow eye bolt. It is sewn on a belt or spliced on a line.

Code	L mm	O mm	UM	€
0222350	50	7	PCS	
0222370	70	9	PCS	
0222310	100	14	PCS	



Fixed Eye Spi Snap Shackle

316 Stainless Steel fixed bail spi snap shackle. Used for the spinnaker's or jib's sheets and halyards. The sheet/halyard can be spliced or knotted.

Code	L mm	O mm	UM	€
0222550	55	9	PCS	
0222560	75	12	PCS	
0222590	99	15	PCS	



Swivel Eye Spi Snap Shackle

316 Stainless Steel swivel spi snap shackle. Used for the spinnaker's or jib's sheets and halyards. The sheet/halyard can be spliced or knotted.

Code	L mm	O mm	UM	€
0222670	70	12	PCS	
0222690	90	16	PCS	
0222613	127	22	PCS	



Clevis Pin Swivel Eye Spi Snap Shackle

316 Stainless Steel swivel snap shackle with clevis pin. Used for the spinnaker's or jib's sheets and halyards. In case of spliced halyards, the shackle pin can be easily replaced if worn out.

Code	L mm	O mm	UM	€
0222770	74	12	PCS	
0222790	94	14	PCS	
0222713	138	22	PCS	



MTM Open End Jib Snap Hook

High quality AISI 316 Stainless Steel open end jib snap hook. Outstanding quality control and finish for the most rugged use in sea water. Supplied on elegant presentation card. Working Load (WL) tested and guaranteed. Breaking Load (BL) is 4 times Working Load.

Code	L mm	O mm	WL Kg	BL Kg	UM	€
022252C	50	9	90	360	PCS	
022265C	65	9	120	480	PCS	



MTM Closed End Jib Snap Hook

High quality AISI 316 Stainless Steel closed end jib snap hook. Outstanding quality control and finish for the most rugged use in sea water. Supplied on elegant presentation card. Working Load (WL) tested and guaranteed. Breaking Load (BL) is 4 times Working Load.

Code	L mm	O mm	WL Kg	BL Kg	UM	€
0222350C	50	7	65	260	PCS	
0222370C	70	9	125	500	PCS	
0222310C	100	14	225	900	PCS	



MTM Fixed Eye Spi Snap Shackle

High quality AISI 316 Stainless Steel fixed eye spi snap shackle. Outstanding quality control and finish for the most rugged use in sea water. Supplied on elegant presentation card. Working Load (WL) tested and guaranteed. Breaking Load (BL) is 4 times Working Load.

Code	L mm	O mm	WL Kg	BL Kg	UM	€
0222560C	70	20	450	1800	PCS	
0222590C	100	20	830	3320	PCS	



MTM Swivel Eye Spi Snap Shackle

High quality 316 Stainless Steel swivel eye spi snap shackle. Outstanding quality control and finish for the most rugged use in sea water. Supplied on elegant presentation card. Working Load (WL) tested and guaranteed. Breaking Load (BL) is 4 times Working Load.

Code	L mm	O mm	WL Kg	BL Kg	UM	€
0222670C	70	12	160	640	PCS	
0222690C	90	16	220	880	PCS	
0222613C	127	22	400	1600	PCS	

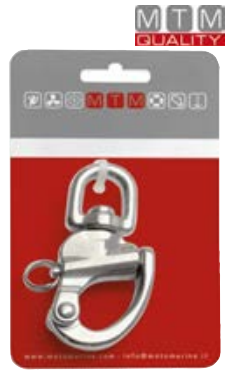

MTM Clevis Pin Swivel Eye Spi Snap Shackle

High quality AISI 316 Stainless Steel swivel eye spi snap shackle with clevis pin. Outstanding quality control and finish for the most rugged use in sea water. Supplied on elegant presentation card. Working Load (WL) tested and guaranteed. Breaking Load (BL) is 4 times Working Load.

Code	L mm	O mm	WL Kg	BL Kg	UM	€
0222770C	74	12	160	640	PCS	
0222790C	94	12	220	880	PCS	
0222713C	138	22	400	1600	PCS	

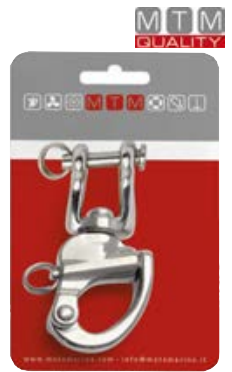

Eye Straps

Polished Stainless Steel wire machined eye straps.

Code	D mm	W mm	W1 mm	UM	€
0333340	4	40	10	PCS	
0333350	5	51	12	PCS	
0333360	6	60	14	PCS	
0333363	8	63	15	PCS	



Stamped Eye Straps L

Wide base Stainless Steel stamped eye straps. Sold in 10 pcs packs.

Code	W mm	W1 mm	UM	€
0333213	45	13	PCS	
0333216	48	16	PCS	



Pad Eye 2

2 Holes Stainless Steel pad eye.

Code	D mm	L mm	W mm	UM	€
0235045	5	45	15	PCS	
0235060	6	60	20	PCS	
0235080	8	80	26	PCS	



3 Holes H.D. Eye Plate

Outstanding quality and finishing casted Stainless Steel 3 holes Dee ring eye plates.



Code	L mm	W mm	D mm	UM	€
0234346	44	44	6	PCS	
0234348	55	55	8	PCS	
0234350	73	75	10	PCS	



Male Lifting Eye

Stainless Steel male lifting eye bolts.

Code	M mm	W mm	D mm	UM	€
0231606	6	15	6	PCS	
0231608	8	20	8	PCS	
0231610	10	25	10	PCS	
0231612	12	30	10	PCS	
0231616	16	35	14	PCS	



Stamped Eye Straps S

Narrow base Stainless Steel stamped eye straps. Sold in 10 pcs packs.

Code	W mm	W1 mm	UM	€
0333022	42	10	PCS	
0333024	47	14	PCS	
0333026	55	20	PCS	



Footman's Loops

Polished Stainless Steel wire machined eye loops.

Code	D mm	W mm	W1 mm	UM	€
0333355	5	78	40	PCS	
0333362	6	92	50	PCS	

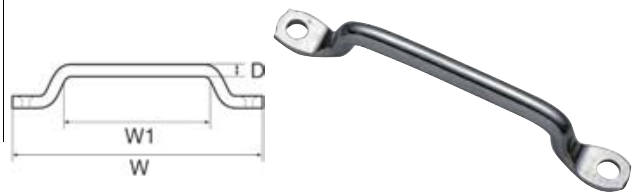

Pad Eye 4

4 Holes Stainless Steel pad eye.

Code	D mm	L mm	W mm	UM	€
0234035	5	35	30	PCS	
0234040	6	40	35	PCS	
0234050	8	50	40	PCS	



W1 Based Lifting eye

Wichard lifting eye on base with folding ring.



Code	L mm	W mm	D mm	BL Kg	UM	€
3781001	40	40	6	1600	PCS	
3781002	45	45	6	2700	PCS	
3781003	57	55	8	4500	PCS	
3781004	75	75	10	9000	PCS	



Female Lifting Eye

Stainless Steel female lifting eye nuts.

Code	M mm	W mm	D mm	UM	€
0231506	6	19	8	PCS	
0231508	8	19	8	PCS	
0231510	10	24	10	PCS	
0231512	12	28	12	PCS	
0231516	16	35	14	PCS	



U-Bolt P

Stainless Steel pinched U-bolts.

Code	D mm	M mm	L mm	W mm	H mm	UM	€
0230004	4	4	64	30	37	PCS	
0230005	5	5	80	35	45	PCS	
0230006	6	6	90	35	45	PCS	
0230008	8	8	100	35	60	PCS	
0230010	10	10	130	50	75	PCS	
0230012	12	12	150	60	85	PCS	

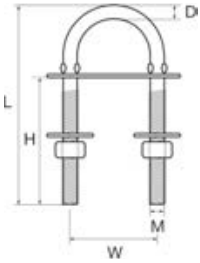

U-Bolt S

Stainless Steel thickened U-Bolts.

Code	D mm	M mm	L mm	W mm	H mm	UM	€
0230105	7	5	80	35	45	PCS	
0230106	8	6	90	35	45	PCS	
0230108	10	8	100	35	60	PCS	
0230110	12	10	130	50	75	PCS	
0230112	14	12	160	73	85	PCS	

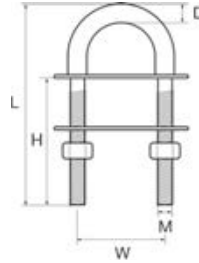

U-Bolt Sealed

Stainless Steel U-Bolts with PVC sealing gasket.

Code	D mm	M mm	L mm	W mm	UM	€
0230208	8	6	80	35	PCS	
0230210	10	8	100	40	PCS	
0230212	12	10	130	50	PCS	
0230214	14	12	155	63	PCS	

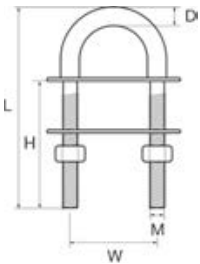

Wichard Coated U-Bolt

Stainless Steel Wichard U-bolts with Rubber sealing gasket.

Code	D mm	L mm	W mm	H mm	BL Kg	UM	€
3781225	5	60	28	30	2000	PCS	
3781226	6	90	32	55	2900	PCS	
3781228	8	100	36	60	4800	PCS	
3781230	10	110	40	65	7000	PCS	

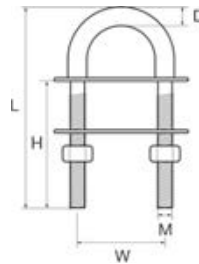

Welded Eye Bolt

Stainless Steel welded eye bolt.



Code	D mm	M mm	W mm	H mm	BL Kg	UM	€
0231040	6	6	13	40	1000	PCS	
0231060	6	6	13	60	1000	PCS	
0231180	8	8	17	70	1800	PCS	
0231110	10	10	21	90	2400	PCS	
0231112	12	12	25	105	3500	PCS	

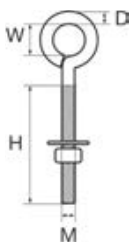

Turned Eye Bolt

Stainless Steel turned eye bolt.



Code	D mm	M mm	W mm	H mm	BL Kg	UM	€
0231240	5	6	16	40	1100	PCS	
0231260	5	6	16	60	1100	PCS	
0231280	6	8	20	80	1300	PCS	
0231210	8	10	25	100	2600	PCS	
0231212	10	12	30	140	3500	PCS	

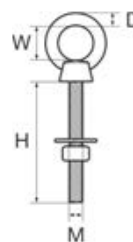

316 Stainless Steel MTM Modular Turnbuckle

316 Stainless Steel MTM modular turnbuckles.

Components must be purchased separately in order to assemble desired turnbuckle.

L = Left Threaded

R = Right Threaded



Code	Ref	Thread	L mm	Wire ø mm	UM	€
3500025	Body	M5 (L/R)	80		PCS	
3500026	Body	M6 (L/R)	90		PCS	
3500028	Body	M8 (L/R)	105		PCS	
3500030	Body	M10 (L/R)	125		PCS	
3500032	Body	M12 (L/R)	150		PCS	
3500034	Body	M14 (L/R)	165		PCS	
3500036	Body	M16 (L/R)	190		PCS	
3500056	Open Body	M6 (L/R)	102		PCS	
3500058	Open Body	M8 (L/R)	121		PCS	
3500060	Open Body	M10 (L/R)	135		PCS	
3500062	Open Body	M12 (L/R)	170		PCS	
3500135	T-Fork L	M5 (L)	39		PCS	
3500136	T-Fork L	M6 (L)	50		PCS	
3500138	T-Fork L	M8 (L)	57		PCS	
3500140	T-Fork L	M10 (L)	68		PCS	
3500142	T-Fork L	M12 (L)	82		PCS	
3500144	T-Fork L	M14 (L)	95		PCS	
3500146	T-Fork L	M16 (L)	102		PCS	
3500225	T-Fork R	M5 (R)	39		PCS	
3500226	T-Fork R	M6 (R)	50		PCS	
3500228	T-Fork R	M8 (R)	57		PCS	
3500230	T-Fork R	M10 (R)	68		PCS	
3500232	T-Fork R	M12 (R)	82		PCS	
3500234	T-Fork R	M14 (R)	95		PCS	
3500236	T-Fork R	M16 (R)	102		PCS	
3500155	T-Toggle L	M5 (L)	42		PCS	
3500156	T-Toggle L	M6 (L)	48		PCS	
3500158	T-Toggle L	M8 (L)	56		PCS	
3500160	T-Toggle L	M10 (L)	67		PCS	
3500162	T-Toggle L	M12 (L)	81		PCS	
3500164	T-Toggle L	M14 (L)	89		PCS	
3500166	T-Toggle L	M16 (L)	103		PCS	
3500245	T-Toggle R	M5 (R)	42		PCS	
3500246	T-Toggle R	M6 (R)	48		PCS	
3500248	T-Toggle R	M8 (R)	56		PCS	
3500250	T-Toggle R	M10 (R)	67		PCS	
3500252	T-Toggle R	M12 (R)	81		PCS	
3500254	T-Toggle R	M14 (R)	89		PCS	
3500256	T-Toggle R	M16 (R)	103		PCS	
3500803	T-Terminal R	M6 (R)	100 (48-L1)	3	PCS	
3500804	T-Terminal R	M8 (R)	117 (57-L1)	4	PCS	
3500805	T-Terminal R	M10 (R)	130 (63-L1)	5	PCS	
3500806	T-Terminal R	M12 (R)	162 (80-L1)	6	PCS	
3500807	T-Terminal R	M14 (R)	180 (90-L1)	7	PCS	
3500808	T-Terminal R	M16 (R)	200 (100-L1)	8	PCS	
3500823	T-Rapid R	M6 (R)	86 (39-L1)	3	PCS	
3500814	T-Rapid R	M6 (R)	92 (45-L1)	4	PCS	
3500824	T-Rapid R	M8 (R)	111 (54-L1)	4	PCS	
3500825	T-Rapid R	M10 (R)	128 (65-L1)	5	PCS	
3500826	T-Rapid R	M12 (R)	162 (82-L1)	6	PCS	

316 Stainless Steel Open Body UNF Modular Turnbuckles

Open Body AISI 316 Stainless Steel UNF inch threaded modular turnbuckles.
Turnbuckle components must be purchased separately in order to compose the desired combination.
L = Left Thread
R = Right Thread

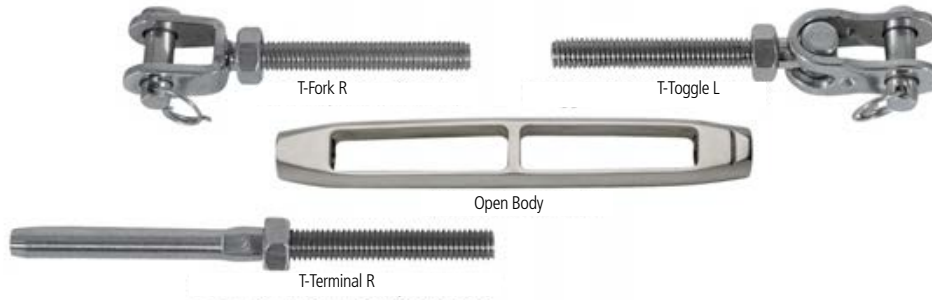

Code	Ref	UNF Thread	L mm	Wire ø mm	UM	€
3500310	Open Body	1/4	102		PCS	
3500312	Open Body	5/16	121		PCS	
3500314	Open Body	3/8	135		PCS	
3500316	Open Body	1/2	170		PCS	
3500320	T-Fork R	1/4	50		PCS	
3500322	T-Fork R	5/16	57		PCS	
3500324	T-Fork R	3/8	68		PCS	
3500326	T-Fork R	1/2	82		PCS	
3500330	T-Toggle L	1/4	50		PCS	
3500332	T-Toggle L	5/16	57		PCS	
3500334	T-Toggle L	3/8	68		PCS	
3500336	T-Toggle L	1/2	82		PCS	
3500340	T-Terminal R	1/4	97	3	PCS	
3500342	T-Terminal R	5/16	115	4	PCS	
3500344	T-Terminal R	3/8	128	5	PCS	

316 Stainless Steel Standard Turnbuckles

Polished 316 Stainless Steel classic turnbuckles.



Code	Thread	BL Kg	UM	€
3500004	M4	340	PCS	
3500005	M5	560	PCS	
3500006	M6	770	PCS	
3500008	M8	1390	PCS	
3500010	M10	2180	PCS	
3500012	M12	3200	PCS	
3500014	M14	4360	PCS	
3500016	M16	5700	PCS	



- AISI 316 STAINLESS STEEL TERMINALS AND LINK TANGS -

Swage Eye Terminal

316 Stainless Steel swage eye terminal.



Code	Wire ø mm	D mm	D1 mm	L mm	BL Kg	UM	€
3501703	3	6,3	6,5	62	1000	PCS	
3501704	4	7,5	8,5	77	1350	PCS	
3501705	5	9,1	10,5	87	2500	PCS	
3501706	6	12,5	13,0	107	4500	PCS	
3501707	7	14,25	15	118,5	5400	PCS	
3501708	8	16,1	14,5	133	6700	PCS	



Swage Fork Terminal

316 Stainless Steel swage fork terminal.



Code	Wire ø mm	D mm	L mm	BL Kg	UM	€
3501603	3	6,3	68	1250	PCS	
3501604	4	7,5	77	1800	PCS	
3501605	5	9,1	87	2650	PCS	
3501606	6	12,5	109	4000	PCS	
3501607	7	14,25	116	5800	PCS	
3501608	8	16,1	148	6500	PCS	

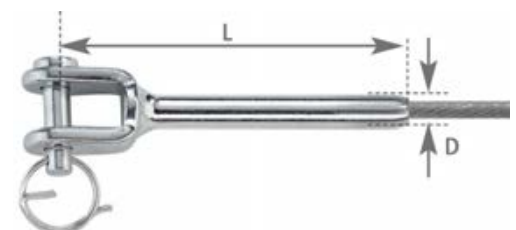

Swage Toggle Terminal

316 Stainless Steel swage toggle terminal.

Code	Wire ø mm	D mm	L mm	BL Kg	UM	€
3501623	3	6,3	75	670	PCS	
3501624	4	7,5	89	1400	PCS	
3501625	5	9,1	104	1700	PCS	
3501626	6	12,5	127	4000	PCS	
3501628	8	16,1	163	7000	PCS	

MTM

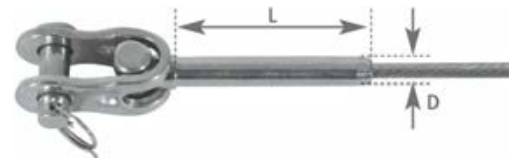
**Swage Mast Terminal**

316 Stainless Steel mast swage terminals.

Code	Wire ø mm	Accessories	UM	€
3503103	3		PCS	
3503104	4		PCS	
3503105	5		PCS	
3503106	6		PCS	
3503303		Mast Plate 50 x 15 mm (3 mm Terminal)	PCS	
3503305		Mast Plate 88 x 26 mm (4/5 mm Terminal)	PCS	
3503306		Mast Plate 122 x 40 mm (6 mm Terminal)	PCS	

MTM

**Pelican Hook**

316 Stainless Steel pelican hooks with swage terminal.

Code	Wire ø mm	UM	€
3504006	3	PCS	
3504008	4	PCS	
3504010	5	PCS	
3504012	6	PCS	

MTM

**Eye Rapid Terminal**

316 AISI Stainless Steel eye rapid terminals. Exceptional holding power equal to the wire breaking load. Easy to mount, just insert the steel wire into the terminal and the spindle automatically catches it. Suitable for all types of steel wires (19/49/133 wires).

Code	Wire ø mm	D mm	L mm	A mm	BL Kg	UM	€
3500403	3	6,5	50	16	800	PCS	
3500404	4	8,5	58	18	1500	PCS	
3500405	5	10,5	70	22	2200	PCS	
3500406	6	12,5	84	25	3200	PCS	

MTM

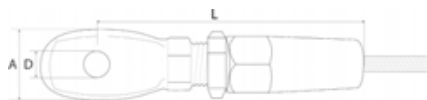
**Fork Rapid Terminal**

316 AISI Stainless Steel fork rapid terminals. Exceptional holding power equal to the wire breaking load. Easy to mount, just insert the steel wire into the terminal and the spindle automatically catches it. Suitable for all types of steel wires (19/49/133 wires).

Code	Wire ø mm	D mm	L mm	B mm	H mm	BL Kg	UM	€
3500503	3	6	55	6	8	800	PCS	
3500504	4	8	62	8	8	1500	PCS	
3500505	5	10	74	10	10	2200	PCS	
3500506	6	12	89	12	12	3200	PCS	

MTM

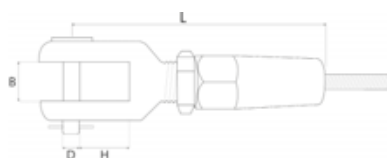

Short Link Tang

Stainless Steel pierced link tang.

Code	L mm	W mm	Holes ø mm	UM	€
3500108	80	14	5	PCS	
3500110	100	14	6	PCS	
3500112	120	14	6	PCS	

**Long Link Tang**

Stainless Steel pierced link tang.

Code	L mm	W mm	Holes ø mm	UM	€
3500114	150	14	6	PCS	
3500120	200	14	10	PCS	
3500111	1000	14	10	PCS	

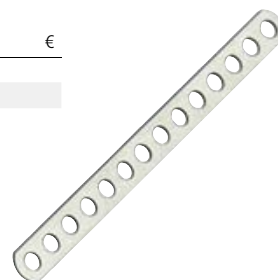
**Spring Rings**

Stainless Steel safety spring rings.

Code	ø mm	UM	€
3501510	10 x 1,5	PCS	
3501514	16 x 1,5	PCS	
3501518	18 x 1,5	PCS	
3501523	22 x 1,5	PCS	

**Safety Cotter Rings**

Stainless Steel safety cotter rings with no slip out pin.

Code	ø mm	UM	€
3501411	11 x 1,0	PCS	
3501415	15 x 1,2	PCS	
3501420	20 x 1,5	PCS	
3501425	25 x 1,8	PCS	

**- RIGGING LIFELINES AND WIRES -****Plastic Coated Stainless Steel Lifeline**

19 strand Stainless Steel lifeline covered with white vinyl.

Code	External ø mm	S/Steel Wire ø mm	Reel m	UM	€
061650620	6	3	20	PCK	
061650630	6	3	30	PCK	
061650650	6	3	50	PCK	
061650820	8	4	20	PCK	
061650830	8	4	30	PCK	
061650850	8	4	50	PCK	

**1 x 19 Stainless Steel Wire Rope**

19 strand 316 Stainless Steel wire rope available in 50 m coil. Superior quality, checked and tested.

Code	Wire ø mm	Breaking Load Kg	gr/m ±	UM	€
540190150	2	340	20	PCK	
540190250	2,5	550	32	PCK	
540190350	3	750	46	PCK	
540190450	4	1400	79	PCK	
540190550	5	2100	125	PCK	
540190650	6	3000	178	PCK	
540190750	7	4100	240	PCK	
540190850	8	5400	320	PCK	
540191050	10	8500	495	PCK	

**7 x 7 Stainless Steel Wire Rope**

49 strand 316 Stainless Steel wire rope available in 50 m coil. Superior quality, checked and tested.

Code	Wire ø mm	Breaking Load Kg	gr/m ±	UM	€
540490150	2	235	14	PCK	
540490250	2,5	380	22	PCK	
540490350	3	500	31	PCK	
540490450	4	1000	61	PCK	
540490550	5	1600	94	PCK	
540490650	6	2200	133	PCK	
540490850	8	4100	246	PCK	
540491050	10	5200	375	PCK	

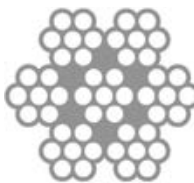
**7 x 19 Stainless Steel Wire Rope**

133 strand 316 Stainless Steel wire rope available in 50 m coil. Superior quality, checked and tested.

Code	Wire ø mm	Breaking Load Kg	gr/m ±	UM	€
541330150	2	250	15	PCK	
541330250	2,5	350	22	PCK	
541330350	3	600	40	PCK	
541330450	4	950	60	PCK	
541330550	5	1400	90	PCK	
541330650	6	2100	138	PCK	
541330850	8	3800	240	PCK	
541331050	10	6000	375	PCK	

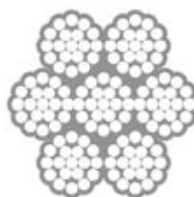

Stainless Steel Flat Wire Clamps

Stainless Steel flat clamps for wire ropes.

Code	Wire ø mm	UM	€
5424222	2	PCS	
5424223	3	PCS	
5424224	4	PCS	
5424225	5	PCS	
5424226	6	PCS	

**Stainless Steel Flat Double Wire Clamps**

Stainless Steel flat double clamps for wire ropes.

Code	Wire ø mm	UM	€
5424232	2	PCS	
5424233	3	PCS	
5424234	4	PCS	
5424235	5	PCS	
5424236	6	PCS	

**Stainless Steel Clamps**

Stainless Steel clamps for quick locking of wire or textile ropes.

Code	Rope ø mm	UM	€
5424122	2	PCS	
5424123	3	PCS	
5424140	4	PCS	
5424150	5	PCS	
5424160	6	PCS	
5424180	8	PCS	
5424110	10	PCS	
5424112	12	PCS	
5424114	14	PCS	

**Copper Oval Sleeves**

Copper oval sleeves for splicing.

Code	Rope ø mm	UM	€
5424002	2	PCS	
5424003	3	PCS	
5424004	4	PCS	
5424005	5	PCS	
5424006	6	PCS	
5424008	8	PCS	

**Swaging Tool**

Swaging tool to compress oval sleeves for diameter 2/2,5/3/4/5 mm wires.

Code	Type	UM	€
5424026	ECO	PCS	
5424025	PROFI	PCS	

**Wire Cutters**

Pliers wire cutters for rebars up to 6 mm and wires up to 9 mm.

Code	Type	L mm	UM	€
5424038	ECO	520	PCS	
5424035	PROFI	335	PCS	

**White Plastic Thimbles**

White Nylon thimbles that prevent the wear of ropes and wires.

Code	Rope ø mm	UM	€
5430004	4	PCS	
5430005	5	PCS	
5430006	6	PCS	
5430008	8	PCS	
5430010	10	PCS	
5430012	12	PCS	
5430014	14	PCS	
5430016	16	PCS	
5430018	18	PCS	
5430020	20	PCS	
5430022	22	PCS	
5430024	24	PCS	

**Stainless Steel Thimbles**

AISI 316 Stainless Steel thimbles. Prevent the wear of ropes and wires.

Code	Rope ø mm	UM	€
5425001	2	PCS	
5425002	2,5	PCS	
5425003	3	PCS	
5425004	4	PCS	
5425005	5	PCS	
5425006	6	PCS	
5425008	8	PCS	
5425010	10	PCS	
5425012	12	PCS	
5425014	14	PCS	
5425016	16	PCS	
5425018	18	PCS	
5425020	20	PCS	
5425022	22	PCS	
5425024	24/26	PCS	
5425028	28/30	PCS	
5425032	32/34	PCS	
5425036	36/38	PCS	
5425040	40/42	PCS	



Sail Bow - Bow Ambo

Sailboats marine grade 316 Stainless Steel bow ambos.

Code	Rail ø mm	H mm	Width mm	Length mm	UM	€
0611645	22	450	800 (± 150)	900	PCS	
0611660	22	600	740 (± 150)	1100	PCS	

**Stern Handrail**

Stern mount Stainless Steel handrail with lifeline eyelets.

Code	Rail ø mm	Height mm	Width mm	UM	€
0611802	25	610	325	PCS	

**Triangular Stanchion Bases**

Stainless Steel triangular stanchion bases. Base dimensions 95 x 95 x 77 mm.

Code	For Stanchions ø mm	Base	UM	€
0612525	25	Flat	PCS	
0612625	25	Angled 6°	PCS	

**Lifeline Netting H600 mm**

100% Polyester lifeline netting. H600 mm. Diamond welded the cheapest, square knotted the safest.

Code	Type	Package m	UM	€
3215508	Diamond Welded	20	PCK	
3215509	Diamond Welded	30	PCK	
3215510	Diamond Welded	50	PCK	
3215512	Square Knotted	20	PCK	
3215511	Square Knotted	30	PCK	
3215513	Square Knotted	50	PCK	

Sail Stern - Stern Ambo

Sailboats marine grade 316 Stainless Steel stern ambos. Composed with 2 parts, left and right.

Code	Rail ø mm	H mm	Back L mm	Side L mm	Corner	UM	€
0611745	22	450	350	400	100°	PCS	
0611760	22	600	430	100°	PCS		

**Stainless Steel Stanchions**

Stainless Steel cone stanchions ø 25 mm.

Code	H mm	Holes	Wheelbase mm	UM	€
0612045	505	2	295	PCS	
0612060	610	2	300	PCS	
0612075	725	2	355	PCS	

**Square Stanchion Bases**

Stainless Steel square stanchion bases. Base dimensions 91 x 64 mm.

Code	For Stanchions ø mm	Base	UM	€
0612425	25	Flat	PCS	
0612426	25	Angled 6°	PCS	



Navishell Turnbuckle Cover

Water repellent UV rays resistant acrylic fabric Navishell turnbuckle cover. The stabilized indelible colour does not fade and remain intense even after 3 years of continuous use. Endowed with velcro for an easy and safe mount.

Code	L cm	Color	UM	€
3840046	37	BLUE NAVY	PCS	
3840047	47	BLUE NAVY	PCS	
3840048	61	BLUE NAVY	PCS	
3840120	37	GREY	PCS	
3840121	47	GREY	PCS	
3840122	61	GREY	PCS	

**PVC Turnbuckle Cover**

Soft PVC turnbuckle covers. Sold in pairs.

Code	L mm	Turnbuckle ø mm	Pcs	UM	€
3840007	380	6	2	PR	
3840008	420	8/10	2	PR	
3840012	500	12/14	2	PR	

**Save-Sail Wheels**

Save-sail chafe protectors. Fits 5 mm wire but it can be drilled to fit up to 10 mm wire. Sold in pairs.

Code	Pcs / Pack	UM	€
3840105	2	PR	

**PVC Spreader Boots**

Soft PVC spreader boots.

Code	Shroud ø mm	Spreader ø mm	H mm	UM	€
3841006	5/6	28	91	PCS	
3841008	7/8	30	86	PCS	
3841010	10/12	54	120	PCS	

**Ocean Spreaders Covers**

The unique flexible Polyurethane design fits all spreaders from 100 to 360 mm circumference. It also provides perfect protection against knocks from spreaders of neighbouring boats in case of rolling. Easy to fit with included nylon fasteners. Sold in pairs.

Code	Dimensions cm	UM	€
3841030	20 x 10 x 11	PR	

**Leather Spreader Boot**

Treated genuine leather fine protection for spreaders. Four sizes available. The inner side is lined with Neoprene for a perfect fit. The protection is complete with a long Velcro strap to fit even wide spreaders. Just cut the Velcro strap to a suitable length and mount the boot with the Velcro in the inner side. Sold in pairs.

Code	Size	Continuous Shroud	Linked Shroud	UM	€
3841042	S	55 <> 95 mm		PR	
3841043	M	95 <> 122 mm	74 <> 95 mm	PR	
3841044	L	122 <> 154 mm	105 <> 122 mm	PR	
3841046	XL		122 <> 154 mm	PR	



Columbus Rail Cover

UV resistant 600 DEN fabric Columbus Rail Cover with foam interior. Double Velcro closure: one internal to cover the rail, one external to fix the cover.

Code	L cm	UM	€
3840059	60	PCS	
3840060	100	PCS	

**Navishell Rail Cover**

Water repellent and UV rays resistant acrylic fabric Navishell rail cover. The stabilized indelible colour does not fade and remain intense even after 3 years of continuous use. Endowed with strong zipper for an easy and safe mount.

Code	L cm	Colour	UM	€
3840041	50	BLUE NAVY	PCS	
3840042	75	BLUE NAVY	PCS	
3840043	100	BLUE NAVY	PCS	
3840110	50	GREY	PCS	
3840111	75	GREY	PCS	
3840112	100	GREY	PCS	

**Sail Defender Stanchion Cover**

Solid Polyurethane cushion. It protects the genoa from the constant rubbing on the turnbuckle between the lifeline and the pulpit. Easy fitting on the stanchion with two included nylon clips to provide a perfect hold. 4 pieces packs.

Code	Dimensions cm	UM	€
3841034	10 x 7 x 3,4	PCK	

**Sail Defender Lifeline Cover**

Solid Polyurethane cushion protects the genoa from the constant rubbing on the turnbuckle between the lifeline and the pulpit. It can be applied to any kind of pulpit with coaxial lifeline in an easy and rapid way. Includes five nylon clips which provide a perfect hold in any condition. Sold in pairs.

Code	Dimensions cm	UM	€
3840054	32 x 7 x 4,5	PR	

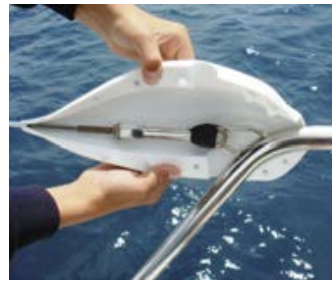
**Leather Protection for Rails**

Treated genuine leather fine protection for rail terminals. Easy to mount thanks to pre-punched leather. The package includes needle and thread. Sold in pairs.

Code	UM	€
3841052	PR	

**Leather Protection for Stanchion Pole**

Treated genuine leather fine protection for stanchion poles. Easy to mount thanks to pre-punched leather. The package includes needle and thread. Sold in pairs.

Code	UM	€
3841054	PR	



S/Steel 6MM Bearing Blocks

Blocks for sheets up to 6 mm. Stainless Steel cheeks, D20 mm sheave.



Code	Ref	UM	€
3600000	Single Pin	PCS	
3600001	Single	PCS	
3600004	Single with Extractable Pin	PCS	
3600006	Single with Extractable Shackle	PCS	

**HS 4MM Micro Bearing Blocks for Wire**

Ball bearing HS blocks for Steel wires and Dyneema sheets up to 4 mm.

Stainless Steel ball bearings, sheave and cheeks.

Sheave diameter 19 mm.

Breaking load 450 Kg.



Code	Ref	UM	€
3601350	Single	PCS	
3601362	Single Swivel	PCS	
3601351	Single with Becket	PCS	
3601353	Single Swivel with Becket	PCS	
3601355	Double	PCS	
3601354	Double with Becket	PCS	
3601356	Triple	PCS	
3601364	Triple with Cam Cleat and Becket	PCS	
3601365	Cheek Block	PCS	
3601366	Upright Block	PCS	
3601368	Upright Spring Block	PCS	
3601371	Single Recessed Cheek Block	PCS	
3601372	Double Recessed Cheek Block	PCS	

**HS 6MM Micro Bearing Blocks**

Ball bearing HS blocks for sheets up to 6 mm.

Stainless Steel ball bearings and cheeks.

Sheave diameter 19 mm.

Breaking load 450 Kg.



Code	Ref	UM	€
3601050	Single	PCS	
3601062	Single Swivel	PCS	
3601051	Single with Becket	PCS	
3601053	Single Swivel with Becket	PCS	
3601061	Fiddle Block with V Cleat	PCS	
3601059	Fiddle Block with V Cleat and Becket	PCS	
3601055	Double	PCS	
3601054	Double with Becket	PCS	
3601056	Triple	PCS	
3601064	Triple with Cam Cleat and Becket	PCS	
3601065	Cheek Block	PCS	
3601066	Upright Block	PCS	
3601068	Upright Spring Block	PCS	
3601071	Single Recessed Cheek Block	PCS	
3601072	Double Recessed Cheek Block	PCS	



HS 8MM Bearing Blocks

Ball bearing HS blocks for sheets up to 8 mm.

Stainless Steel ball bearings and frame.

Sheave diameter 28 mm.

Breaking load 600 Kg.



Code	Ref	UM	€
3608965	Single Bar	PCS	
3608951	Single	PCS	
3608953	Single Swivel	PCS	
3608955	Single Swivel with Shackle	PCS	
3608952	Single with Becket	PCS	
3608954	Single Swivel with Becket	PCS	
3608959	Single Swivel with Cam Cleat and Becket	PCS	
3608961	Double	PCS	
3608962	Double with Becket	PCS	
3608963	Triple	PCS	
3608964	Triple with Becket	PCS	
3608966	Triple Swivel with Cam Cleat and Becket	PCS	

**HS 10MM Bearing Blocks**

Ball bearing HS blocks for sheets up to 10 mm.

Stainless Steel ball bearings and frame.

Sheave diameter 36 mm.

Breaking load 850 Kg.



Code	Ref	UM	€
3609053	Single Swivel	PCS	
3609054	Single Swivel with Becket	PCS	
3609056	Fiddle Block Swivel	PCS	
3609061	Single Swivel with Cam Cleat and Becket	PCS	
3609059	Fiddle Block Swivel with Cam Cleat and Becket	PCS	
3609062	Double	PCS	
3609063	Double with Becket	PCS	
3609064	Triple	PCS	

**HS 12MM Bearing Blocks**

Ball bearing HS blocks for sheets up to 12 mm.

Stainless Steel ball bearings and frame.

Sheave diameter 50 mm.

Breaking load 1000 Kg.



Code	Ref	UM	€
3609151	Single Swivel	PCS	
3609152	Single Swivel with Becket	PCS	
3609153	Fiddle Block Swivel	PCS	
3609154	Fiddle Block Swivel with Becket	PCS	
3609155	Single Swivel with Cam Cleat and Becket	PCS	
3609157	Fiddle Block Swivel with Cam Cleat and Becket	PCS	
3609159	Double	PCS	
3609160	Double with Becket	PCS	
3609161	Triple	PCS	



HS 6MM Blocks

Plain bearing HS blocks for sheets up to 6 mm.
Stainless Steel cheeks.
Sheave diameter 26 mm.
Breaking load 700 Kg.



Code	Ref	UM	€
3600030	Single Bar	PCS	
3600031	Single	PCS	
3600032	Single Swivel	PCS	
3600033	Single with Becket	PCS	
3600041	Single with V Cleat and Becket	PCS	
3600048	Single Cheek Block	PCS	
3600036	Double	PCS	
3600037	Double with Becket	PCS	
3600042	Double with V Cleat and Becket	PCS	
3600038	Triple	PCS	
3600039	Triple with Becket	PCS	
3600043	Triple with V Cleat and Becket	PCS	

**HS 8MM Blocks**

Plain bearing HS blocks for sheets up to 8 mm.
Stainless Steel frame.
Sheave diameter 28 mm.
Breaking load 600 Kg.



Code	Ref	UM	€
3608901	Single	PCS	
3608904	Single with Becket	PCS	
3608911	Double	PCS	
3608972	Swivel Head	PCS	

**HS 10MM Blocks**

Plain bearing HS blocks for sheets up to 10 mm.
Stainless Steel frame.
Sheave diameter 36 mm.
Breaking load 850 Kg.



Code	Ref	UM	€
3609001	Single	PCS	
3609004	Single with Becket	PCS	
3609006	Fiddle Block	PCS	
3609007	Fiddle Block with Becket	PCS	
3609011	Single Swivel with Cam Cleat and Becket	PCS	
3609009	Fiddle Block Swivel with Cam Cleat and Becket	PCS	
3609012	Double	PCS	
3609013	Double with Becket	PCS	
3609072	Swivel Head	PCS	



HS 12MM Blocks

Plain bearing HS blocks for sheets up to 12 mm.

Stainless Steel frame.

Sheave diameter 50 mm.

Breaking load 1000 Kg.



Code	Ref	UM	€
3609100	Single	PCS	
3609102	Single with Becket	PCS	
3609103	Fiddle Block	PCS	
3609107	Fiddle Block Swivel with Cam Cleat and Becket	PCS	
3609109	Double	PCS	
3609110	Double with Becket	PCS	
3609111	Triple	PCS	
3609172	Swivel Head	PCS	

**HS 14MM Blocks**

Plain bearing HS blocks for sheets up to 14 mm.

Stainless Steel frame.

Sheave diameter 70 mm.

Breaking load 2500 Kg.



Code	Ref	UM	€
3601256	Single Swivel	PCS	
3601257	Single with Becket	PCS	
3601263	Fiddle Block Swivel	PCS	
3601262	Fiddle Block Swivel with Cam Cleat and Becket	PCS	
3601260	Double	PCS	
3601261	Double with Becket	PCS	



Master Windrider 29MM Ball Bearing Blocks

Ball bearing Master blocks with 29 mm sheave. Ultra light UV resistant fiber reinforced composite material case. With swivel shackle.
UV Stabilized Delrin high sliding bearing balls.



Code	Ref	L mm	Line mm	WL Kg	BL Kg	UM	€
3612910	Single	66	<8	160	500	PCS	
3612911	Single with Becket	78	<8	160	500	PCS	
3612920	Double	66	<8	160	500	PCS	
3612921	Double with Becket	78	<8	160	500	PCS	
3612930	Triple	66	<8	160	500	PCS	
3612931	Triple with Becket	78	<8	160	500	PCS	
3612950	Stand-up	53	<8	160	500	PCS	

**Master Windrider 40MM Ball Bearing Blocks**

Ball bearing Master blocks with 40 mm sheave. Ultra light UV resistant fiber reinforced composite material case. With swivel shackle.
UV Stabilized Delrin high sliding bearing balls.

NOTE: Working/breaking load of blocks with cam are based on the strength of the cam.



Code	Ref	L mm	Line mm	WL Kg	BL Kg	UM	€
3614010	Single	90	<10	230	800	PCS	
3614011	Single with Becket	107	<10	230	800	PCS	
3614012	Single + Becket & Cam Cleat	107	<8	80	200	PCS	
3614013	Fiddle Block	120	<10	230	800	PCS	
3614014	Fiddle Block with Becket	135	<10	230	800	PCS	
3614015	Fiddle Block + Cam Cleat & Becket	135	<8	80	200	PCS	
3614020	Double	90	<10	230	800	PCS	
3614021	Double with Becket	107	<10	230	800	PCS	
3614030	Triple	90	<10	230	800	PCS	
3614031	Triple with Becket	107	<10	230	800	PCS	
3614032	Triple + Becket & Cam Cleat	107	<8	80	200	PCS	
3614050	Stand-up	67	<10	230	800	PCS	



Master Windrider 57MM Ball Bearing Blocks

Ball bearing Master blocks with 57 mm sheave. Ultra light UV resistant fiber reinforced composite material case. The swivel shackle can be positioned in two directions thanks to the block lever. UV Stabilized Delrin high sliding bearing balls.

NOTE: Working/breaking load of blocks with cam are based on the strength of the cam.

Code	Ref	L mm	Line mm	WL Kg	BL Kg	UM	€
3615710	Single	122	<10	370	1200	PCS	
3615711	Single with Becket	144	<10	370	1200	PCS	
3615712	Single + Becket & Cam Cleat	144	<10	100	250	PCS	
3615713	Fiddle Block	158	<10	370	1200	PCS	
3615714	Fiddle Block with Becket	179	<10	370	1200	PCS	
3615715	Fiddle Block + Cam Cleat & Becket	179	<10	100	250	PCS	
3615720	Double	122	<10	370	1200	PCS	
3615721	Double with Becket	144	<10	370	1200	PCS	
3615730	Triple	122	<10	370	1200	PCS	
3615731	Triple with Becket	144	<10	370	1200	PCS	
3615732	Triple + Becket & Cam Cleat	144	<10	100	250	PCS	

**Master Windrider 75MM Ball Bearing Blocks**

Ball bearing Master blocks with 75 mm sheave. Ultra light UV resistant fiber reinforced composite material case. The swivel shackle can be positioned in two directions thanks to the block lever. UV Stabilized Delrin high sliding bearing balls.

NOTE: Working/breaking load of blocks with cam are based on the strength of the cam.

Code	Ref	L mm	Line mm	WL Kg	BL Kg	UM	€
3617510	Single	141	<14	560	1700	PCS	
3617511	Single with Becket	168	<14	560	1700	PCS	
3617512	Single + Becket & Cam Cleat	168	<12	100	250	PCS	
3617520	Double	148	<14	560	1700	PCS	
3617521	Double with Becket	174	<14	560	1700	PCS	
3617530	Triple	148	<14	560	1700	PCS	
3617531	Triple with Becket	174	<14	560	1700	PCS	
3617532	Triple + Becket & Cam Cleat	174	<12	100	250	PCS	



Master 50MM Plain Bearing Blocks

Great load capacity plain bearing Master blocks with 50 mm sheave. Ultra light UV resistant fiber reinforced composite material case. The swivel shackle can be positioned in two directions thanks to the block lever.

NOTE: Working/breaking load of blocks with cam are based on the strength of the cam.

Code	Ref	L mm	Line mm	WL Kg	BL Kg	UM	€
3610510	Single with Becket	101	<10	522	1050	PCS	
3610511	Single with Becket	120	<10	522	1050	PCS	
3610512	Fiddle	130	<10	522	1050	PCS	
3610513	Fiddle with Becket	147	<10	522	1050	PCS	
3610515	Single + Becket & Cam Cleat	120	<10	100	250	PCS	
3610516	Fiddle + Becket & Cam Cleat	147	<10	100	250	PCS	
3610520	Double	101	<10	522	1050	PCS	
3610521	Double with Becket	120	<10	522	1050	PCS	
3610530	Triple	101	<10	522	1050	PCS	
3610532	Triple + Becket & Cam Cleat	120	<8	100	250	PCS	
3610505	Single Toggle Head	90	<10	522	1050	PCS	

**Master 60MM Plain Bearing Blocks**

Great load capacity plain bearing Master blocks with 60 mm sheave. Ultra light UV resistant fiber reinforced composite material case. The swivel shackle can be positioned in two directions thanks to the block lever.

NOTE: Working/breaking load of blocks with cam are based on the strength of the cam.

Code	Ref	L mm	Line mm	WL Kg	BL Kg	UM	€
3610610	Single	114	<12	600	1500	PCS	
3610611	Single with Becket	138	<12	600	1500	PCS	
3610612	Fiddle	154	<12	600	1500	PCS	
3610613	Fiddle with Becket	178	<12	600	1500	PCS	
3610614	Fiddle Block + Cam Cleat & Becket	178	<12	100	250	PCS	
3610605	Single Toggle Head	107	<12	600	1500	PCS	



Master 72MM Plain Bearing Blocks

Great load capacity plain bearing Master blocks with 72 mm sheave. Ultra light UV resistant fiber reinforced composite material case. The swivel shackle can be positioned in two directions thanks to the block lever.

NOTE: Working/breaking load of blocks with cam are based on the strength of the cam.

Code	Ref	L mm	Line mm	WL Kg	BL Kg	UM	€
3610710	Single	140	<12	1000	2000	PCS	
3610711	Single with Becket	168	<12	1000	2000	PCS	
3610712	Fiddle	190	<12	1000	2000	PCS	
3610713	Fiddle with Becket	213	<12	1000	2000	PCS	
3610714	Fiddle Block + Cam Cleat & Becket	213	<12	100	250	PCS	
3610720	Double	143	<12	1000	2000	PCS	
3610721	Double with Becket	170	<12	1000	2000	PCS	
3610705	Single Toggle Head	138	<12	1000	2000	PCS	



Master 90MM Plain Bearing Blocks

Great load capacity plain bearing Master blocks with 90 mm sheave. Ultra light UV resistant fiber reinforced composite material case. The swivel shackle can be positioned in two directions thanks to the block lever.

Code	Ref	L mm	Line mm	WL Kg	BL Kg	UM	€
3610910	Single	188	<14	1800	3000	PCS	
3610911	Single with Becket	225	<14	1800	3000	PCS	
3610912	Fiddle	250	<14	1800	3000	PCS	
3610913	Fiddle with Becket	280	<14	1800	3000	PCS	



Master Hercules Aluminum Ball Bearing Blocks

Ball bearing Master blocks with sheave and black anodized Aluminum case. The swivel shackle can be positioned in two directions thanks to the block lever.

UV Stabilized Delrin high sliding bearing balls.

Code	Ref	ø mm	L mm	Line mm	WL Kg	BL Kg	UM	€
3611510	Single	57	140	<16	1100	2000	PCS	
3611710	Single	75	165	<19	1600	3200	PCS	
3611511	Single with Becket	57	170	<16	1100	2000	PCS	
3611711	Single with Becket	75	197	<19	1600	3200	PCS	
3611512	Single Toggle Head	57	95	<16	1100	2000	PCS	
3611712	Single Toggle Head	75	118	<19	1600	3200	PCS	



Single Block

One piece tefloned black Oxidised Aluminum frame very robust block without screws and pins. With resin sheaves and double selfcaptive ball bearing that does not need lubrication. Complete with high resistance Stainless Steel swiveling top and shackle. The high quality materials guarantee high work loads and extra lightness.

Code	Ref	Sheave mm	Line mm	Working Load Kg	UM	€
3600901	Single Block	50	<10	600	PCS	
3600911	Single Block + Cam	50	<10	600	PCS	
3600931	Single Block	60	<12	800	PCS	
3600951	Single Block + Cam	60	<12	800	PCS	
3600961	Single Block	70	<12	1300	PCS	
3600981	Single Block + Cam	70	<12	1300	PCS	

**antal****Single Block with Becket**

One piece tefloned black Oxidised Aluminum frame very robust block without screws and pins. With resin sheaves and double selfcaptive ball bearing that does not need lubrication. Complete with high resistance Stainless Steel swiveling top and shackle. The high quality materials guarantee high work loads and extra lightness.

Code	Ref	Sheave mm	Line mm	Working Load Kg	UM	€
3600902	Single Block with Becket	50	<10	600	PCS	
3600912	Single Block with Becket + Cam	50	<10	600	PCS	
3600932	Single Block with Becket	60	<12	800	PCS	
3600952	Single Block with Becket + Cam	60	<12	800	PCS	
3600962	Single Block with Becket	70	<12	1300	PCS	
3600982	Single Block with Becket + Cam	70	<12	1300	PCS	

**antal****Fiddle Block**

One piece tefloned black Oxidised Aluminum frame very robust block without screws and pins. With resin sheaves and double selfcaptive ball bearing that does not need lubrication. Complete with high resistance Stainless Steel swiveling top and shackle. The high quality materials guarantee high work loads and extra lightness.

Code	Ref	Sheave mm	Line mm	Working Load Kg	UM	€
3600903	Fiddle Block	50	<10	600	PCS	
3600913	Fiddle Block + Cam	50	<10	600	PCS	
3600933	Fiddle Block	60	<12	800	PCS	
3600953	Fiddle Block + Cam	60	<12	800	PCS	
3600963	Fiddle Block	70	<12	1300	PCS	
3600983	Fiddle Block + Cam	70	<12	1300	PCS	

**antal****Fiddle Block with Becket**

One piece tefloned black Oxidised Aluminum frame very robust block without screws and pins. With resin sheaves and double selfcaptive ball bearing that does not need lubrication. Complete with high resistance Stainless Steel swiveling top and shackle. The high quality materials guarantee high work loads and extra lightness.

Code	Ref	Sheave mm	Line mm	Working Load Kg	UM	€
3600904	Fiddle Block with Becket	50	<10	600	PCS	
3600914	Fiddle Block with Becket + Cam	50	<10	600	PCS	
3600934	Fiddle Block with Becket	60	<12	800	PCS	
3600954	Fiddle Block with Becket + Cam	60	<12	800	PCS	
3600964	Fiddle Block with Becket	70	<12	1300	PCS	
3600984	Fiddle Block with Becket + Cam	70	<12	1300	PCS	

**antal**

Double Block

One piece tefloned black Oxidised Aluminum frame very robust block without screws and pins. With resin sheaves and double selfcaptive ball bearing that does not need lubrication. Complete with high resistance Stainless Steel swiveling top and shackle. The high quality materials guarantee high work loads and extra lightness.

Code	Ref	Sheave mm	Line mm	Working Load Kg	UM	€
3600905	Double Block	50	<10	800	PCS	
3600915	Double Block + Cam	50	<10	800	PCS	
3600935	Double Block	60	<12	1300	PCS	
3600955	Double Block + Cam	60	<12	1300	PCS	
3600965	Double Block	70	<12	2200	PCS	
3600985	Double Block + Cam	70	<12	2200	PCS	

**antal****Double Block with Becket**

One piece tefloned black Oxidised Aluminum frame very robust block without screws and pins. With resin sheaves and double selfcaptive ball bearing that does not need lubrication. Complete with high resistance Stainless Steel swiveling top and shackle. The high quality materials guarantee high work loads and extra lightness.

Code	Ref	Sheave mm	Line mm	Working Load Kg	UM	€
3600906	Double Block with Becket	50	<10	800	PCS	
3600916	Double Block with Becket + Cam	50	<10	800	PCS	
3600936	Double Block with Becket	60	<12	1300	PCS	
3600956	Double Block with Becket + Cam	60	<12	1300	PCS	
3600966	Double Block with Becket	70	<12	2200	PCS	
3600986	Double Block with Becket + Cam	70	<12	2200	PCS	

**antal****Triple Block**

One piece tefloned black Oxidised Aluminum frame very robust block without screws and pins. With resin sheaves and double selfcaptive ball bearing that does not need lubrication. Complete with high resistance Stainless Steel swiveling top and shackle. The high quality materials guarantee high work loads and extra lightness.

Code	Ref	Sheave mm	Line mm	Working Load Kg	UM	€
3600907	Triple Block	50	<10	800	PCS	
3600917	Triple Block + Cam	50	<10	800	PCS	
3600937	Triple Block	60	<12	1300	PCS	
3600957	Triple Block + Cam	60	<12	1300	PCS	
3600967	Triple Block	70	<12	2200	PCS	
3600987	Triple Block + Cam	70	<12	2200	PCS	

**antal****Triple Block with Becket**

One piece tefloned black Oxidised Aluminum frame very robust block without screws and pins. With resin sheaves and double selfcaptive ball bearing that does not need lubrication. Complete with high resistance Stainless Steel swiveling top and shackle. The high quality materials guarantee high work loads and extra lightness.

Code	Ref	Sheave mm	Line mm	Working Load Kg	UM	€
3600908	Triple Block with Becket	50	<10	800	PCS	
3600918	Triple Block with Becket + Cam	50	<10	800	PCS	
3600938	Triple Block with Becket	60	<12	1300	PCS	
3600958	Triple Block with Becket + Cam	60	<12	1300	PCS	
3600968	Triple Block with Becket	70	<12	2200	PCS	
3600988	Triple Block with Becket + Cam	70	<12	2200	PCS	

**antal**

Web Block for Line Connection

One piece tefloned black Oxidised Aluminum frame very robust block without screws and pins. With resin sheaves and double selfcaptive ball bearing that does not need lubrication. The high quality materials guarantee high work loads and extra lightness.

Code	Ref	Sheave mm	Line mm	Working Load Kg	UM	€
3600909	Web Block	50	<10	600	PCS	
3600939	Web Block	60	<12	800	PCS	
3600969	Web Block	70	<12	1300	PCS	

**U-Bolt Stand-up Block**

One piece tefloned black Oxidised Aluminum frame very robust block without screws and pins. With resin sheaves and double selfcaptive ball bearing that does not need lubrication. Complete with high resistance Stainless Steel swiveling top and U bolt. The high quality materials guarantee high work loads and extra lightness.

Code	Ref	Sheave mm	Line mm	Working Load Kg	UM	€
3600923	Bolt Stand-up Block	50	<10	500	PCS	
3600943	Bolt Stand-up Block	60	<12	800	PCS	
3600973	Bolt Stand-up Block	70	<12	1300	PCS	

**Single and Double Cheek Blocks**

One piece tefloned black Oxidised Aluminum frame very robust block without screws and pins. With resin sheaves and double selfcaptive ball bearing that does not need lubrication. Complete with high resistance Stainless Steel screws. The high quality materials guarantee high work loads and extra lightness.

Code	Ref	Sheave mm	Line mm	Working Load Kg	UM	€
3600921	Single Cheek Block	50	<10	600	PCS	
3600922	Double Cheek Block	50	<10	600	PCS	
3600941	Single Cheek Block	60	<12	800	PCS	
3600942	Double Cheek Block	60	<12	800	PCS	
3600971	Single Cheek Block	70	<12	1300	PCS	
3600972	Double Cheek Block	70	<12	1300	PCS	

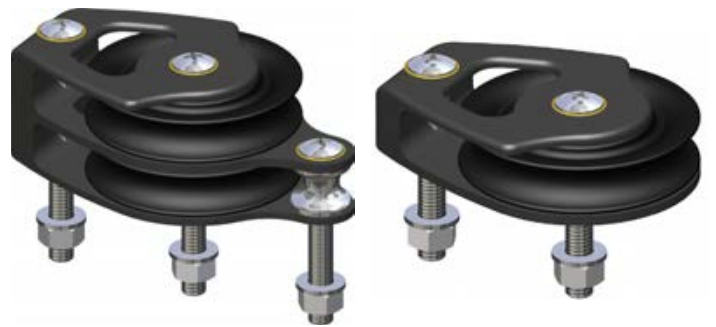
**- ANTAL SNATCH BLOCKS -****Mini Snatch Blocks D=32 mm**

High strength resin Ball Bearing Mini Snatch Block D=32 mm. It can be fastened both with a line or with a shackle. The Snap Ring is a line loop with an easy locking system to avoid accidental opening.

Code	Ref	Head	Sheave mm	Line mm	Working Load Kg	UM	€
3601140	Block	Fixed	32	<8	250	PCS	
3601143	Snap Ring					PCS	

**Snatch Blocks D=40 and 60 mm**

The cheekplate revolves around the sheave axle allowing the block to open; a safety ball prevent the block from opening and an adjustable screw allows to set the ball on locked position. There is a becket for the "hanging line". Material: sheave with composite fibre main bearing and double side ball bearing. Hard anodized and teflon coated Aluminum cheekplates with side rubber protections (yellow rubber on the revolving cheekplate).

Code	Block	Head	Sheave mm	Line mm	Working Load Kg	UM	€
3601145	D40	Fixed	40	<12	700	PCS	
3601146	D60	Fixed	60	<14	1300	PCS	



Vertical Lead Cheek Block

Ball Bearing sheave with mounted fairlead and spring. Stainless Steel reinforcements.



Code	ø Sheave mm	ø Sheet mm	UM	€
3602423	28	8	PCS	
3602424	35	10	PCS	
3602425	50	12	PCS	



Clamp Sheet Lead

Stainless Steel sheet lead with ø 25 mm clamp.



Code	UM	€
3602431	PCS	



HS VB Cheek Block

HS Cheek block with ball bearing sheave. Sheave axis-base distance: 25 mm. Stainless Steel body. Sheet <8 mm / BL = 300 Kg.



Code	Ref	Accessories	UM	€
3722418	HS VB Cheek Block		PCS	
3722419		Vertical Mount Base Strap	PCS	



HS Deck 12 Cheek Block

HS cheek block for sheet <12 mm.



Code	L mm	BL Kg	UM	€
3722912	96	1000	PCS	



Clamp Cheek Block

ø 25 mm Clamp cheek block.



Code	ø Sheave mm	ø Sheet mm	UM	€
3602428	28	8	PCS	
3602430	35	10	PCS	



Single Plate Block

Lead block with ø 20 mm sheave. Sheet <6 mm.



Code	UM	€
3600008	PCS	



HS 8B Cheek Block

HS Cheek block. Ball Bearing Sheave ø 28 mm. Stainless Steel body. Sheet <8 mm / BL = 600 Kg.



Code	UM	€
3722408	PCS	



Fairleads

Plastic body fairlead.

Code	Line mm	UM	€
3703603	<9	PCS	
3703602	<13	PCS	
3703601	<15	PCS	



HS Deck Series Midi

HS multiple deck organizers with 1 - 2 - 3 sheaves.

Code	Sheave	L mm	Line ø mm	Breaking Load Kg	UM	€
3722951	1	69	<12	800	PCS	
3722952	2	124	<12	800	PCS	
3722953	3	178	<12	800	PCS	



V-CAM 814 Antal Organizer

Organizer that allows the line to be diverted towards the winch. Black burnished Aluminum casing and sheaves with ball bearings. Maximum working load 400 Kg.

Code	Sheave	L mm	Line ø mm	Working Load Kg	UM	€
3723013	3	110	<14	400	PCS	
3723014	4	139	<14	400	PCS	
3723015	5	168	<14	400	PCS	
3723016	6	197	<14	400	PCS	

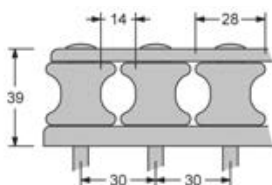

Antal Organizers D=40 - D=50

Black anodized Aluminum case, high-strength resin sheaves with a double side ball bearing. All models are supplied with 316 S/Steel screws, washers and mounting nuts.

Code	Sheave	D mm	P mm	L mm	Line ø mm	Working Load Kg	UM	€
3723512	2	40	44	111	<14	600	PCS	
3723513	3	40	44	155	<14	600	PCS	
3723514	4	40	44	199	<14	600	PCS	
3723515	5	40	44	243	<14	600	PCS	
3723516	6	40	44	287	<14	600	PCS	
3723502	2	50	52	133	<16	800	PCS	
3723503	3	50	52	185	<16	800	PCS	
3723504	4	50	52	237	<16	800	PCS	
3723505	5	50	52	289	<16	800	PCS	
3723506	6	50	52	341	<16	800	PCS	

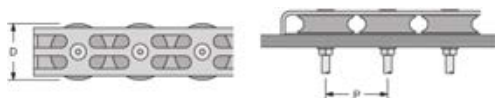

Master Deck Organizers

Master deck organizers with 57 mm sheaves and black anodized Aluminum case. UV Stabilized Delrin high sliding bearing balls. Sheaves wheelbase 78.5 mm.

Code	Sheave	Dim mm	Line ø mm	Working Load Kg	UM	€
3723212	2	L169 x H24	<16	2000	PCS	
3723213	3	L248 x H24	<16	2000	PCS	
3723214	4	L326 x H24	<16	2000	PCS	
3723215	5	L405 x H24	<16	2000	PCS	



Antal Rings

Black Anodized Aluminum light and strong Antal rings ideal for all deck solutions.

Code	ø mm	Hole ø mm	For Rope ø mm	Working Load Kg	UM	€
3723110	18	7	5	400	PCS	
3723111	25	10	7	800	PCS	
3723112	35	14	10	1600	PCS	
3723113	50	20	14	3200	PCS	
3723114	70	28	20	6400	PCS	
3723115	99	38	28	10000	PCS	

**Antal Solid Rings**

Reduced friction mirror polished black Anodized Aluminum light and strong Antal Solid Rings. Ideal for reefing, for 3D setting of the genoa sheet and for all deck solutions.

Code	ø mm	Hole ø mm	Working Load Kg	UM	€
3723120	56	30	1800	PCS	
3723121	64	34	2800	PCS	
3723122	76	40	4400	PCS	
3723123	94	50	6500	PCS	

**- CAM CLEATS -****HS Cleat**

Camlan HS Midi and Mini Cleats.

Code	Line mm	UM	€
3712507	3<6	PCS	
3712505	8<13	PCS	

**Single HS Fairlead**

Single fairlead for Mini and Midi cam cleats.

Code	Ref	UM	€
3713520	Mini	PCS	
3713530	Midi	PCS	

**Double HS Fairlead**

Double fairlead for Mini and Midi cam cleats.

Code	Ref	UM	€
3713522	Mini	PCS	
3713532	Midi	PCS	

**Master Cleats**

UV Rays and corrosion resistant black anodized Aluminum Master Cleats.

Cams with constant tension spring and Delrin high sliding bearing balls.

Note: the breaking load is twice the working load.

Code	Line mm	H mm	Wheelbase mm	Working Load Kg	UM	€
3714527	3<6	22	27 (M4)	100	PCS	
3714538	3<12	27	38 (M5)	150	PCS	
3714552	6<16	32	52,2 (M6)	250	PCS	

**Master Cleat Fairlead**

Top Fairlead for Master cleats.

Code	Wheelbase Ref	UM	€
3714507	Small (27 mm)	PCS	
3714508	Medium (38 mm)	PCS	



Easylock I Stopper

Easylock I stopper that allows to grip or lack sheets under tension.

Anodized Aluminum casing.

Working Load 300 Kg. Length 108 mm.

Codet	Stopper	Line ø mm	Spare Parts	UM	€
3707810	Single	6<10		PCS	
3707820	Double	6<10		PCS	
3707830	Triple	6<10		PCS	
3707831			Spare Lever	PCS	



easy

Easylock Mini Stopper

Easylock Mini stopper that allows to grip or lack sheets under tension.

Anodized Aluminum casing.

Working Load 450 Kg. Length 115 mm.

Codet	Stopper	Line ø mm	Spare Parts	UM	€
3708010	Single	6<10		PCS	
3708020	Double	6<10		PCS	
3708030	Triple	6<10		PCS	
3708031			Spare Lever	PCS	



easy

Easylock Midi Stopper

Easylock Midi stopper that allows to grip or lack sheet under tension.

Anodized Aluminum casing.

Length 140 mm. Working Load 700 Kg.

Codet	Stopper	Line ø mm	Spare Parts	UM	€
3709210	Single	6<12		PCS	
3709220	Double	6<12		PCS	
3709230	Triple	6<12		PCS	
3709231			Spare Lever	PCS	



easy

Master XTC Stopper

UV Rays resistant black composite Master XTC stopper with Stainless Steel and anodized Aluminum inner parts. Designed for easy engagement and quick release of the line under static high loads.

Codet	Stopper	Line ø mm	Working Load Kg	Max Load Kg	UM	€
3707501	Single	8<12	300	600	PCS	
3707502	Double	8<12	300	600	PCS	
3707503	Triple	8<12	300	600	PCS	



MASTER

Antal Cam 611 Line Stoppers

Antal Cam 611 stopper that allows to retrieve and stop the line in the new position while the jammer is closed, or to grip and lack the line under load.

Code	Ref	Line ø mm	UM	€
3703010	Single	6<11	PCS	
3703020	Double	6<11	PCS	
3703030	Triple	6<11	PCS	

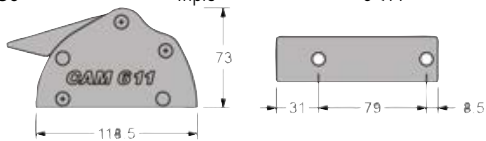

antal

Antal V-CAM 814 Line Stoppers

Antal V-CAM 814 stopper with raised holding power. Doesn't cause line cover damage. Perfect for composite lines as Kevlar, Vectran and Spectra. Excellent on Polyester. Steel reinforced UV-resistant Resin case, Aluminum base, Steel V-cam and aligning bushing. It can be completely dismantled for simple maintenance and repairing. Line retrieval can be achieved with the lever closed and it can be blocked automatically in new position.

Code	Ref	Line ø mm	UM	€
3707151	Single	8<10	PCS	
3707152	Double	8<10	PCS	
3707153	Triple	8<10	PCS	
3707161	Single	10<12	PCS	
3707162	Double	10<12	PCS	
3707163	Triple	10<12	PCS	
3707171	Single	12<14	PCS	
3707172	Double	12<14	PCS	
3707173	Triple	12<14	PCS	

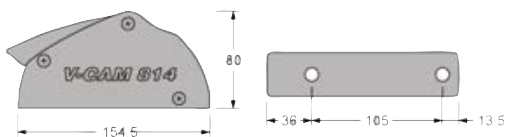

antal

Antal V-GRIP Line Stoppers

Antal V-Grip stopper with raised holding power. Doesn't cause line cover damage. Perfect for composite lines as Kevlar, Vectran and Spectra. Excellent on Polyester. Steel internal construction. No-line slippage. Allows the line to be released under maximum load without the use of a winch. The line can also be tailed through the stopper without opening the cam mechanism. Only 6.5 cm body height.

Code	Ref	Line ø mm	UM	€
3707111	Single	8<12	PCS	
3707121	Double	8<12	PCS	
3707131	Triple	8<12	PCS	
3707112	Single	10<14	PCS	
3707122	Double	10<14	PCS	
3707132	Triple	10<14	PCS	
3707113	Single	12<16	PCS	

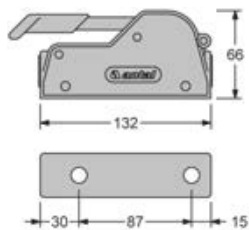

antal

Stopper Lines Sticker Set

54 Stickers set provided in 3 colours: Red, Green and Black. For easy lines identification.

Code	Language	UM	€
3703000	English	PCS	
3703001	French	PCS	
3703002	Italian	PCS	



antal

Direct Speed Winch

One direct speed Antal Winch. Turn the handle clockwise to engage the single direct gear; the handle turns freely counterclockwise.

Code	Ref	Power	Weight Kg	ø mm	ø1 mm	H mm	UM	€
3730110	W6	6.7	0.40	94	60	87	PCS	
3730111	W7	6.7	0.70	97	60	95	PCS	
3730113	W8	7.3	1.50	110	70	105	PCS	

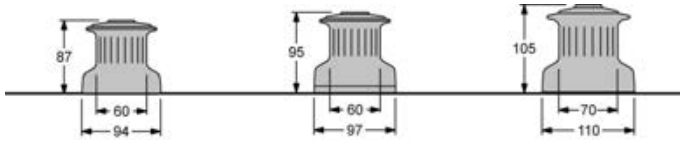
**antal****Reduced Speed Self-Tailing XT Winch**

Self-Tailing XT compact winch with reduced speed giving slow but powerful force. The handle turns freely the other way. For 6<>10 mm sheets.

Code	Ref	Power	Weight Kg	ø mm	ø1 mm	H mm	UM	€
3740211	XT16	14	2.40	112	71	119	PCS	
3740212	XT30	28	2.70	128	73	135	PCS	

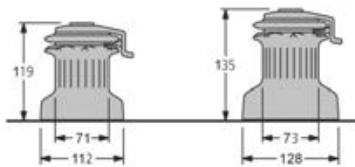
**antal****Direct and Reduced Speed Self-Tailing XT Winch**

Self-Tailing XT Winch with direct and reduced speed. Faster recovery speed combined with reduced dimensions and weight makes these winches the best choice for racing. For 6<>10 mm sheets.

Code	Ref	Power	Weight Kg	ø mm	ø1 mm	H mm	UM	€
3740221	XT16.2	7/14	2.60	112	71	119	PCS	
3740222	XT30.2	7/28	2.90	128	73	135	PCS	

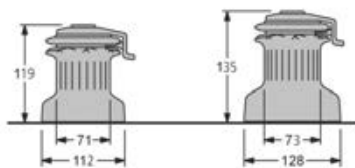
**antal****Two Reduced Speed Self-Tailing XT Winch**

Self-Tailing XT winch with two reduced speed. With the first gear there is a rapid recovery speed even when achieving considerable powers; as the effort increases, the changing of the crank's rotation direction allows to automatically select the second speed which achieves the maximum power. For 6<>14 mm sheets.

Code	Ref	Power	Weight Kg	ø mm	ø1 mm	H mm	UM	€
3740225	XT40	13/40	4.40	153	80	157	PCS	
3740226	XT44	20/43	6.20	173	93	185	PCS	
3740227	XT48	19/47	6.90	182	93	197	PCS	

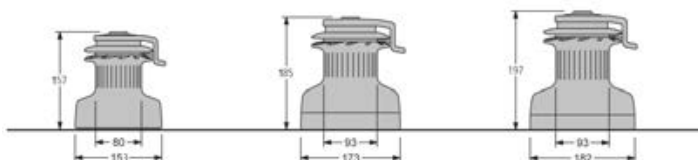
**antal**

Antal Single-Grip Handle

200 and 250 mm (8/10") black Aluminum single grip handles. The handle arm is made of forged Aluminum with lightening holes and it is extremely light. It resists the heaviest torsion. The grip is covered with rubber in order to give a firm hold and runs on two ball bearings to increase its efficiency. All models are available with the lock system which automatically locks the handle on the winch.

Code	Handle	L mm	Weight g	UM	€
3751201	Single-Grip	200	400	PCS	
3751251	Single-Grip	250	460	PCS	

**antal****Antal Power-Grip Handle**

Extremely light black Aluminum 250 mm (10") handles. Available with double grip and the new ball-grip. The forged Aluminum handle arm is lightened with holes and it is extremely light and resistant to the heaviest torsions. The grip is covered with rubber to give a firm hold and runs on two ball bearings to increase its efficiency. All models are available with the lock system which automatically locks the handle on the winch.

Code	Handle	L mm	Weight g	UM	€
3751252	Ball-Grip	250	490	PCS	
3751253	Double	250	540	PCS	

**antal****Antal Speedylock Handle**

Light and tough forged Aluminum winch handle with lightening holes and rubber covered grip handle for better hold. Endowed with practic "Speedylock" lock system which allows very quick engagement and use.

Code	Handle	L mm	Weight g	UM	€
3751200	Single-Grip	250	430	PCS	
3751202	Ball-Grip	250	530	PCS	

**antal****Antal Chrome Handle**

250 mm (10") Light Chromed Bronze handles with two different grips: single and ball grip. The handle arm is made of forged Bronze, it is light and resists the heaviest torsion. The grip is covered with rubber to give a firm hold and runs on two ball bearings to increase its efficiency. All models are available with the lock system which automatically locks the handle on the winch.

Code	Handle	L mm	Weight g	UM	€
3751260	Single-Grip	250	870	PCS	
3751261	Ball-Grip	250	970	PCS	

**antal****Base Single Grip Handle**

This handle is ideal for small and medium sailboats. Lightweight and strong construction with locking system. It floats.

Code	L mm	UM	€
3750224	200	PCS	
3750225	250	PCS	

**MTM**

Genoa Car and Track 26x4

Black burnished Aluminum car with 316 Stainless Steel stop pin and Nylon sliding inserts. Swiveling ($\pm 50^\circ$) 316 Stainless Steel sheave base. Resin sheave with 2 side (self-captive) ball bearings, wide section for two sheets. Working load (SWL) 800 Kg.

antal

T Track with 50 mm spaced holes.
High resistance anodized Aluminum.
Mounting with 5 mm screws.

Code	Ref	Rail	UM	€
3722026	Car		PCS	
3722028		26x4 - 1.5 m	PCS	
3722029		26x4 - 2.0 m	PCS	
3722027		Rail End Fitting	PCS	

**Genoa Car and Track 32x6**

Black burnished Aluminum car on low-friction Nylon sliding inserts. Swiveling ($\pm 50^\circ$) 316 Stainless Steel sheave base. Resin sheave with 2 side (self-captive) ball bearings, wide section for two sheets. 316 Stainless Steel pin with lock-up position. Frontal becket.

antal

T Track with 100 mm spaced holes.
High resistance anodized Aluminum.
Mounting with 6 mm screws.

Code	Ref	Rail	UM	€
3722032	Car		PCS	
3722034		32x6 - 1.5 m	PCS	
3722035		32x6 - 2.0 m	PCS	
3722033		Rail End Fitting	PCS	

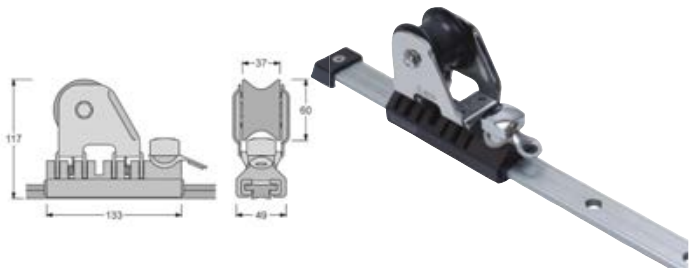
**Genoa Car and Track 40x8**

Black burnished Aluminum car on low-friction Nylon sliding inserts. Swiveling ($\pm 50^\circ$) 316 Stainless Steel sheave base. Aluminum sheave with 2 side ball bearings. 316 Stainless Steel pin with lock-up position. Becket for remote control line. SWL 3800 Kg.

antal

T Track with 100 mm spaced holes.
High resistance anodized Aluminum.
Mounting with 8 mm screws.

Code	Ref	Rail	UM	€
3722040	Car		PCS	
3722044		40x8 - 2.0 m	PCS	
3722045		40x8 - 2.5 m	PCS	
3722041		Rail End Fitting	PCS	

**Main Traveler System Size 100 for Boats up to 33'**

Size 100 main ball bearing traveller system.
Car dimensions: 62 x L98 mm. Working load (SWL) 820 Kg.
Fitted with 1/4" balls (50 Torlon balls on the lower races and 50 Delrin on the upper races).
Diameter of the side sheaves for the car control: 35 mm.
The complete systems includes 1.5 m track.

antal

Code	Complete System	Car Control	Track L m	UM	€
3723601	Mod 4261	1:1	1.5	PCS	
3723603	Mod 4904	3:1	1.5	PCS	



HS20 Genoa Car and Tracks

Genoa HS20 car and tracks for boats up to 7.20 m (24').

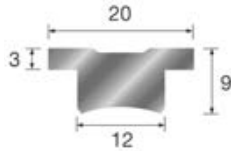

Code	Ref	Rail	UM	€
3722001	Car with Block		PCS	
3720015		1.50 m	PCS	
3720020		2.00 m	PCS	
3722002	Rail Terminal		PCS	

**HS25 Genoa Car and Tracks**

Genoa HS25 car and tracks for boats up to 10.20 m (34').

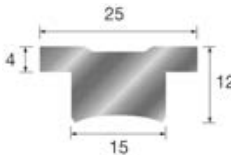

Code	Ref	Rail	UM	€
3722005	Car with Block		PCS	
3720115		1.50 m	PCS	
3720120		2.00 m	PCS	
3722007	Rail Terminal		PCS	

**HS32 Genoa Car and Tracks**

Genoa HS32 car and tracks for boats up to 13 m (43').

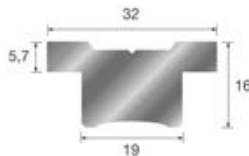

Code	Ref	Rail	UM	€
3722010	Car with Block		PCS	
3720215		1.50 m	PCS	
3720220		2.00 m	PCS	
3722012	Rail Terminal		PCS	

**HS24 Mainsail Car with Rail**

HS24 Mainsail car for boats up to 9,60 m (32').

T21 low-profile rails (stand needed).

L25 self-standing rails (stand not needed).



Code	Ref	Rail	UM	€
3722104	Car		PCS	
3722112	End Stop With Cam		PR	
3722152		T21 - 1.20 m	PCS	
3722155		T21 - 1.50 m	PCS	
3722158		T21 - 1.80 m	PCS	
3722121	T21 Rail Terminals		PR	
3722162		L25 - 1.20 m	PCS	
3722165		L25 - 1.50 m	PCS	
3722168		L25 - 1.80 m	PCS	
3722122	L25 Rail Terminals		PR	



Bamar Foresail Furler

Bamar manual foresail furler with furling drum, Aluminum foils and swivel halyard top. Rotation happens on double series Torlon ball bearings which do not require lubrication or maintenance. The furling drum is hollow inside, thus allowing the installation with the stay passing through and with turnbuckle inside.

The drum kit is complete with link plates that may be cut to measure in order to modify the height of the tack.

The foil kit is complete with reeve, 1,5 m middle foil, middle and reinforcement connectors, terminal ring and swivel halyard top.

For a complete foresail furler following parts are necessary: 1 drum kit, 1 foil kit and middle foils that should reach or exceed the stay length if added to the length of the foil kit.

Code	Type	Ref	Stay mm	Max Stay L m	UM	€
3782000	C0	Drum Kit	4<>7	9	PCK	
3782003	C0	2,5 m Foil Kit	4<>7		PCK	
3782001	C0T	Drum Kit	4<>7	10,5	PCK	
3782004	C0T	2,5 m Foil Kit	4<>7		PCK	
3782010	C1	Drum Kit	5<>8	15	PCK	
3782011	C1	2,5 m Foil Kit	5<>8		PCK	
3782012	C0-C0T-C1	1,5 m Middle Foil	4<>8		PCS	
3782020	C2	Drum Kit	8<>10	18	PCK	
3782021	C2	2,5 m Foil Kit	8<>10		PCK	
3782030	C3	Drum Kit	10<>12	19,5	PCK	
3782031	C3	2,5 m Foil Kit	10<>12		PCK	
3782032	C2 - C3	1,5 m Middle Foil	8<>12		PCS	
3782040	C4	Drum Kit	12<>14	21	PCK	
3782041	C4	4,5 m Foil Kit	12<>14		PCK	
3782042	C4	1,5 m Middle Foil	12<>14		PCS	

**Bamar Foresail Furler Accessories and Spare Parts**

Bamar foresail furler accessories and spare parts.

Code	Type	Ref	UM	€
3782060	C0	Reeve Foil	PCK	
3782061	C2 / C3	Reeve Foil	PCK	
3782072	C4	Reeve Foil	PCK	
3782064	C0 / C0T / C1	Connection with Rivet	PCK	
3782066	C2 / C3	Connection with Rivet	PCK	
3782062	C4	Connection with Rivet	PCK	
3782065	C0 / C0T / C1	Connection without Rivet	PCK	
3782067	C2 / C3	Connection without Rivet	PCK	
3782068	C0	Fix Halyard Top with Pulley	PCK	
3782069	C0T	Swivel Halyard Top	PCK	
3782070	C1	Swivel Halyard Top	PCK	
3782071	C2	Swivel Halyard Top	PCK	

**Bamar Stay Adjuster**

Strong and powerful mechanical Bamar stay adjuster, easy to mount and to use. The BTV hand-wheel compact type is supplied with foldable handles. The use of self-lubricating bushes reduces to minimum the friction caused by the screw in case of high loads.

The BTM handle type may be operated with winch handle and is manufactured in Aluminum with double ex-tractions Stainless Steel rams, ensuring longer stroke.

Code	Ref	Stay mm	L mm	Stroke mm	WL Kg	UM	€
3783005	Handle-Wheel BTV	5	420	140	1500	PCK	
3783006	Handle-Wheel BTV	6	530	200	2300	PCK	
3783008	Handle BTM	8	900	300	4400	PCK	
3783010	Handle BTM	10	900	300	5000	PCK	
3783012	Handle BTM	12	950	300	7000	PCK	



Bamar Gennaker e Code 0 Furler

Bamar manual furler for free-flying asymmetric sails such as Asymmetric Spinnaker, Gennaker, Mps and Reacher. Made of Ergal, 17-4PH Steel and Carbon fiber that allows 60% decrease of working load weight. Composed by drum, swivel halyard top and special RollGen anti-torsion stay kit. The drum rotates with endless line and can be used to furl sails with luff integral to the stay, such as Code 0, Drifter, etc. The EVO S drum is a structural stay furler and can contain inside all the line, leaving the deck free of obstacles. The luff control is a double swivel that allows to adjust the tension of the sail luff.



Code	Type	Ref	Max Stay L m	Accessories	UM	€
3787008	RLG-EVO 08	Code 0 Drum Kit	15		PCS	
3787009	RLG-EVO 08	Code 0 Swivel Halyard Top Kit	15		PCS	
3787038	RLG-EVO 08	RollGen Stay kit	15		PCS	
3787058	RLG-EVO 08			Luff Control	PCS	
3787010	RLG-EVO 10	Code 0 Drum Kit	17		PCS	
3787011	RLG-EVO 10	Code 0 Swivel Halyard Top Kit	17		PCS	
3787040	RLG-EVO 10	RollGen Stay Kit	17		PCS	
3787041	RLG-EVO 10	RollGen 3K Stay Kit	20		PCS	
3787060	RLG-EVO 10			Luff Control	PCS	
3787061	RLG-EVO 10			3K Luff Control	PCS	
3787020	RLG-EVO 20	Code 0 Drum Kit	22		PCS	
3787032	RLG-EVO 20	EVO S Drum Kit	22		PCS	
3787021	RLG-EVO 20	Code 0 Swivel Halyard Top Kit	22		PCS	
3787042	RLG-EVO 20	RollGen Stay kit	22		PCS	
3787043	RLG-EVO 20	RollGen 3K Stay Kit	27		PCS	
3787070	RLG-EVO 20			Luff Control	PCS	
3787071	RLG-EVO 20			3K Luff Control	PCS	
3787084				4 m Endless 8 mm Line Kit	PCS	
3787086				6 m Endless 8 mm Line Kit	PCS	
3787088				8 m Endless 8 mm Line Kit	PCS	
3787090				10 m Endless 8 mm Line Kit	PCS	
3787092				12 m Endless 8 mm Line Kit	PCS	
3787093				12 m Endless 10 mm Line Kit	PCS	

**Bamar Vang**

Bamar mechanical kicker with internal Stainless Steel spring pushing up the boom. Manufactured in Anodized Aluminum with special connection terminals integrating pulleys to form a compact line tackle. The line may either be controlled from the cockpit or locked on the kicker using the extra tackle. The spring allows you to adjust the thrust with the simple rotation of the upper tube/terminal.



Code	Ref	L max	Diagonal with 90° Boom	Boat L	Accessories	UM	€
3786010	100	1600 mm	900<->1500 mm	9<->10,5 m		PCS	
3786020	200	2000 mm	1100<->2000 mm	10,5<->13,5 m		PCS	
3786030	300S	2000 mm	1250<->2000 mm	12,5<->16 m		PCS	
3786031	300	2500 mm	1400<->2350 mm	15<->17 m		PCS	
3786040					Type 100 Swivel Mast Connection	PCS	
3786044					Type 200/300S Swivel Mast Connection	PCS	
3786048					Type 300 Swivel Mast Connection	PCS	
3786041					Type 100/200/300S No Groove Boom Connection	PCS	
3786042					Type 100 20 mm Groove Boom Connection	PCS	
3786045					Type 200 25 mm Groove Boom Connection	PCS	
3786043					Type 100 Extra Tackle with Block	PCS	
3786046					Type 200 Extra Tackle with Block	PCS	
3786047					Type 300S Extra Tackle with Block	PCS	
3786050					Type 300 Extra Tackle with Block	PCS	



MTM Cruising Sheet

High tensile 100% Polyester mainsail and spinnaker color-coded sheet.

Features: Double braided pre-stretched Polyester core.

20-plait abrasion resistant smooth braided Polyester cover.



Code	ø mm	Code	daN	Meters	UM	€
3132406200	6	RED	750	200	PCK	
3142406200	6	BLUE	750	200	PCK	
3122406200	6	GREEN	750	200	PCK	
3142606200	6	YELLOW	750	200	PCK	
3132408200	8	RED	1300	200	PCK	
3142408200	8	BLUE	1300	200	PCK	
3122408200	8	GREEN	1300	200	PCK	
3142608200	8	YELLOW	1300	200	PCK	
3132410200	10	RED	2100	200	PCK	
3142410200	10	BLUE	2100	200	PCK	
3122410200	10	GREEN	2100	200	PCK	
3142610200	10	YELLOW	2100	200	PCK	
3132412200	12	RED	2800	200	PCK	
3142412200	12	BLUE	2800	200	PCK	
3122412200	12	GREEN	2800	200	PCK	
3142612200	12	YELLOW	2800	200	PCK	
3132414150	14	RED	4100	150	PCK	
3142414150	14	BLUE	4100	150	PCK	
3122414150	14	GREEN	4100	150	PCK	
3142614150	14	YELLOW	4100	150	PCK	
3132416100	16	RED	5000	100	PCK	
3142416100	16	BLUE	5000	100	PCK	
3122416100	16	GREEN	5000	100	PCK	
3142616100	16	YELLOW	5000	100	PCK	
3132418100	18	RED	7200	100	PCK	
3142418100	18	BLUE	7200	100	PCK	
3122418100	18	GREEN	7200	100	PCK	
3142618100	18	YELLOW	7200	100	PCK	

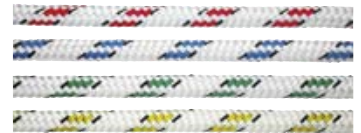

MTM Cruising Sheet Color

High tensile 100% Polyester mainsail and spinnaker full-color sheet.

Features: Double braided core pre-stretched Polyester core.

20-plait abrasion resistant smooth braided Polyester cover.



Code	ø mm	Colour	daN	Meters	UM	€
3132506200	6	RED	750	200	PCK	
3142506200	6	BLUE	750	200	PCK	
3122506200	6	GREEN	750	200	PCK	
3142626200	6	YELLOW	750	200	PCK	
3132508200	8	RED	1300	200	PCK	
3142508200	8	BLUE	1300	200	PCK	
3122508200	8	GREEN	1300	200	PCK	
3142628200	8	YELLOW	1300	200	PCK	
3132510200	10	RED	2100	200	PCK	
3142510200	10	BLUE	2100	200	PCK	
3122510200	10	GREEN	2100	200	PCK	
3142630200	10	YELLOW	2100	200	PCK	
3132512200	12	RED	2800	200	PCK	
3142512200	12	BLUE	2800	200	PCK	
3122512200	12	GREEN	2800	200	PCK	
3142632200	12	YELLOW	2800	200	PCK	
3132514150	14	RED	4100	150	PCK	
3142514150	14	BLUE	4100	150	PCK	
3122514150	14	GREEN	4100	150	PCK	
3142634150	14	YELLOW	4100	150	PCK	



MTM Racing Halyard

Color coded Polyester high tensile halyards braid.
 Features: double braided pre-stretched Polyester core.
 32-Plait abrasion resistant braided Polyester cover.



Code	ø mm	Code	daN	Meters	UM	€
3133806200	6	RED	1000	200	PCK	
3143806200	6	BLUE	1000	200	PCK	
3153806200	6	GREEN	1000	200	PCK	
3153906200	6	YELLOW	1000	200	PCK	
3133808200	8	RED	1800	200	PCK	
3143808200	8	BLUE	1800	200	PCK	
3153808200	8	GREEN	1800	200	PCK	
3153908200	8	YELLOW	1800	200	PCK	
3133810200	10	RED	2500	200	PCK	
3143810200	10	BLUE	2500	200	PCK	
3153810200	10	GREEN	2500	200	PCK	
3153910200	10	YELLOW	2500	200	PCK	
3133812200	12	RED	3200	200	PCK	
3143812200	12	BLUE	3200	200	PCK	
3153812200	12	GREEN	3200	200	PCK	
3153912200	12	YELLOW	3200	200	PCK	
3133814150	14	RED	4500	150	PCK	
3143814150	14	BLUE	4500	150	PCK	
3153814150	14	GREEN	4500	150	PCK	
3153914150	14	YELLOW	4500	150	PCK	

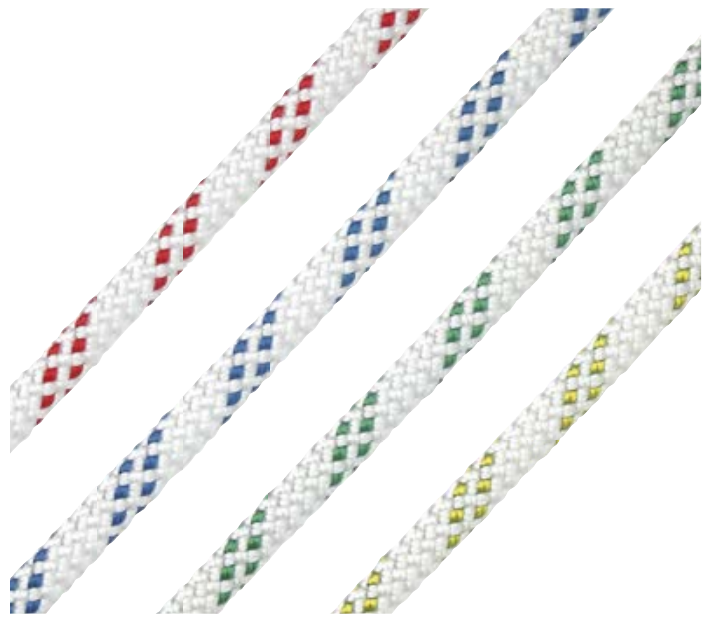

MTM Racing Halyard Color

Full colour coded Polyester high tensile halyards braid. Features: double braided pre-stretched Polyester core. 32-Plait abrasion resistant braided Polyester cover.



Code	ø mm	Colour	daN	Meters	UM	€
3133826200	6	RED	1000	200	PCK	
3143826200	6	BLUE	1000	200	PCK	
3153826200	6	GREEN	1000	200	PCK	
3153926200	6	YELLOW	1000	200	PCK	
3133828200	8	RED	1800	200	PCK	
3143828200	8	BLUE	1800	200	PCK	
3153828200	8	GREEN	1800	200	PCK	
3153928200	8	YELLOW	1800	200	PCK	
3133830200	10	RED	2500	200	PCK	
3143830200	10	BLUE	2500	200	PCK	
3153830200	10	GREEN	2500	200	PCK	
3153930200	10	YELLOW	2500	200	PCK	
3133832200	12	RED	3200	200	PCK	
3143832200	12	BLUE	3200	200	PCK	
3153832200	12	GREEN	3200	200	PCK	
3153932200	12	YELLOW	3200	200	PCK	
3133834150	14	RED	4500	150	PCK	
3143834150	14	BLUE	4500	150	PCK	
3153834150	14	GREEN	4500	150	PCK	
3153934150	14	YELLOW	4500	150	PCK	

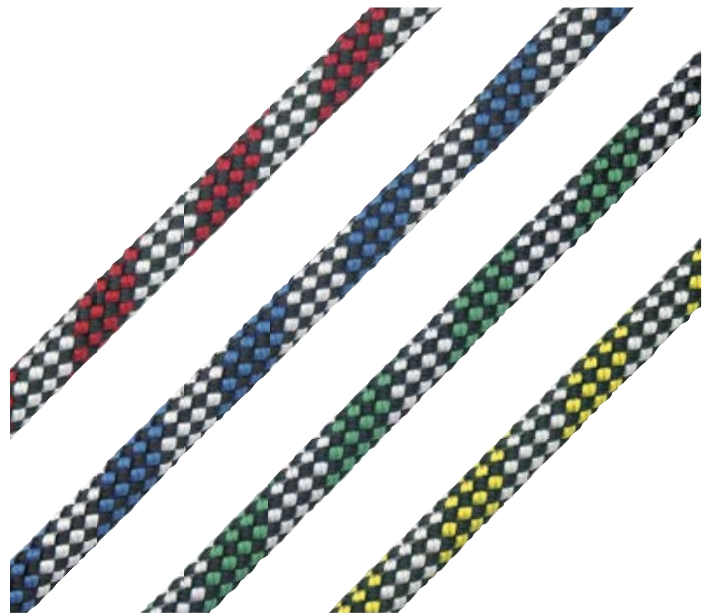

Liros Top-Cruising

Reduced stretch (<5%) classic sheet. Resistant, soft and flexible line for all type of cruising sailboats, perfect for mainsail, jib and spinnaker. Heat set, easy to splice, kink-free, with high-tenacity braided Polyester core and abrasion resistant Poliester cover.

Code	ø mm	Code	daN	Meters	UM	€
3133006200	6	RED	1100	200	PCK	
3133007200	7	RED	1300	200	PCK	
3133008200	8	RED	1650	200	PCK	
3133010200	10	RED	2700	200	PCK	
3133012200	12	RED	3200	200	PCK	
3133014150	14	RED	3800	150	PCK	
3133016100	16	RED	5000	100	PCK	
3133106200	6	BLUE	1100	200	PCK	
3133107200	7	BLUE	1300	200	PCK	
3133108200	8	BLUE	1650	200	PCK	
3133110200	10	BLUE	2700	200	PCK	
3133112200	12	BLUE	3200	200	PCK	
3133114150	14	BLUE	3800	150	PCK	
3133116100	16	BLUE	5000	100	PCK	
3133206200	6	YELLOW	1100	200	PCK	
3133207200	7	YELLOW	1300	200	PCK	
3133208200	8	YELLOW	1650	200	PCK	
3133210200	10	YELLOW	2700	200	PCK	
3133212200	12	YELLOW	3200	200	PCK	
3133214150	14	YELLOW	3800	150	PCK	
3133216100	16	YELLOW	5000	100	PCK	
3133306200	6	BLACK	1100	200	PCK	
3133307200	7	BLACK	1300	200	PCK	
3133308200	8	BLACK	1650	200	PCK	
3133310200	10	BLACK	2700	200	PCK	
3133312200	12	BLACK	3200	200	PCK	
3133314150	14	BLACK	3800	150	PCK	
3133316100	16	BLACK	5000	100	PCK	

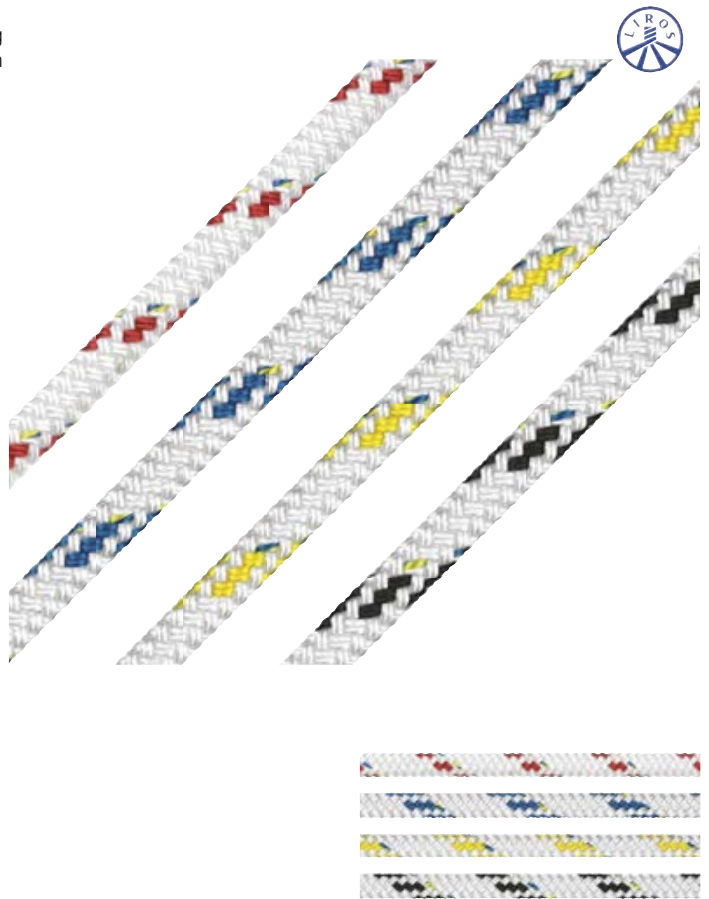

Liros Herkules Colour

Reduced stretch (<5%) quality halyard/sheet. Resistant and extremely versatile line for all type of cruising sailboats. Full coloured line for easy purpose identification. Easy to splice, kink-free. High-tenacity braided Polyester core and abrasion resistant Poliester cover.

Code	ø mm	Colour	daN	Meters	UM	€
3142104250	4	RED	400	250	PCK	
3142105250	5	RED	650	250	PCK	
3142106200	6	RED	800	200	PCK	
3142108200	8	RED	1600	200	PCK	
3142110200	10	RED	2500	200	PCK	
3142112200	12	RED	3500	200	PCK	
3142114150	14	RED	4500	150	PCK	
3142116100	16	RED	5000	100	PCK	
3142304250	4	BLUE NAVY	400	250	PCK	
3142305250	5	BLUE NAVY	650	250	PCK	
3142306200	6	BLUE NAVY	800	200	PCK	
3142308200	8	BLUE NAVY	1600	200	PCK	
3142310200	10	BLUE NAVY	2500	200	PCK	
3142312200	12	BLUE NAVY	3500	200	PCK	
3142314150	14	BLUE NAVY	4500	150	PCK	
3142316100	16	BLUE NAVY	5000	100	PCK	
3142204250	4	YELLOW	400	250	PCK	
3142205250	5	YELLOW	650	250	PCK	
3142206200	6	YELLOW	800	200	PCK	
3142208200	8	YELLOW	1600	200	PCK	
3142210200	10	YELLOW	2500	200	PCK	
3142212200	12	YELLOW	3500	200	PCK	
3142214150	14	YELLOW	4500	150	PCK	
3142216100	16	YELLOW	5000	100	PCK	

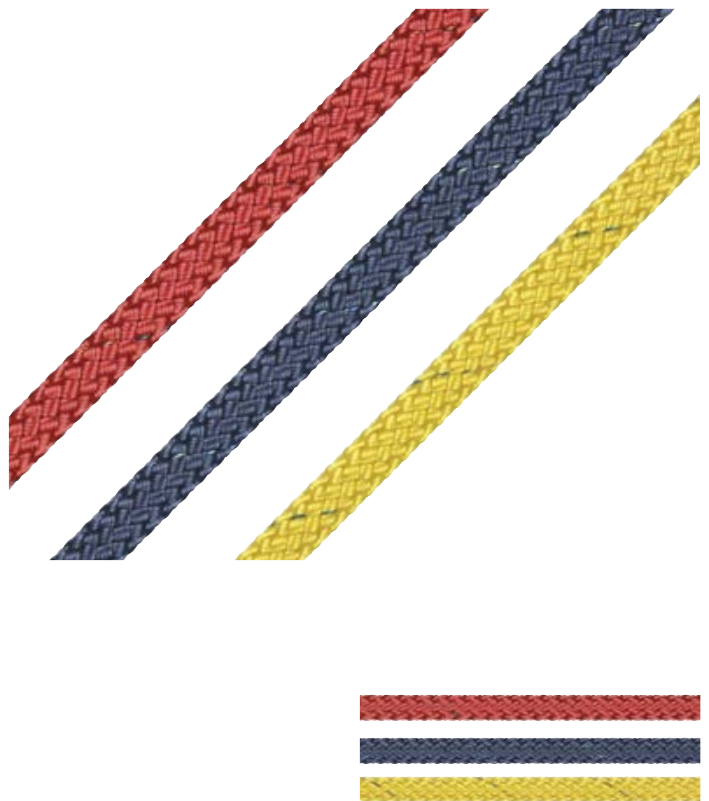

HARDWARE SAILING/COVERS ROPES/FLAGS COVERINGS

Liros Seastar Colour

Reduced stretch (<6%) high quality "hairy" sheet. Soft and flexible line with very good grip. Perfect for cruising sailboats and dinghies, the full colour ensures easy purpose identification of the line. Heat set, with braided Polyester core and yarn matt Polyester cover.



Code	ø mm	Colour	daN	Meters	UM	€
3132008200	8	RED	1000	200	PCK	
3132010200	10	RED	1900	200	PCK	
3132012200	12	RED	2400	200	PCK	
3132014150	14	RED	2900	150	PCK	
3132016100	16	RED	3500	100	PCK	
3132208200	8	BLUE NAVY	1000	200	PCK	
3132210200	10	BLUE NAVY	1900	200	PCK	
3132212200	12	BLUE NAVY	2400	200	PCK	
3132214150	14	BLUE NAVY	2900	150	PCK	
3132216100	16	BLUE NAVY	3500	100	PCK	
3132108200	8	YELLOW	1000	200	PCK	
3132110200	10	YELLOW	1900	200	PCK	
3132112200	12	YELLOW	2400	200	PCK	
3132114150	14	YELLOW	2900	150	PCK	
3132116100	16	YELLOW	3500	100	PCK	

**Liros Herkules Vision**

Reduced stretch (<5%) high quality halyard/sheet. Resistant and extremely versatile line for all type of cruising sailboats. Easy to splice, kink-free. High-tenacity braided Polyester core and abrasion resistant Polyester cover.



Code	ø mm	Colour	daN	Meters	UM	€
3143006200	6	RED	800	200	PCK	
3143008200	8	RED	1600	200	PCK	
3143010200	10	RED	2500	200	PCK	
3143012200	12	RED	3500	200	PCK	
3143014150	14	RED	4500	150	PCK	
3143106200	6	BLUE	800	200	PCK	
3143108200	8	BLUE	1600	200	PCK	
3143110200	10	BLUE	2500	200	PCK	
3143112200	12	BLUE	3500	200	PCK	
3143114150	14	BLUE	4500	150	PCK	
3143206200	6	BLACK	800	200	PCK	
3143208200	8	BLACK	1600	200	PCK	
3143210200	10	BLACK	2500	200	PCK	
3143212200	12	BLACK	3500	200	PCK	
3143214150	14	BLACK	4500	150	PCK	
3143306200	6	ORANGE	800	200	PCK	
3143308200	8	ORANGE	1600	200	PCK	
3143310200	10	ORANGE	2500	200	PCK	
3143312200	12	ORANGE	3500	200	PCK	
3143314150	14	ORANGE	4500	150	PCK	

**Liros Dynamic Plus**

Low stretch (<2%) halyard/sheet. Lightweight, soft and high performance line for all type of running rigging. Dyneema SK78 core with additional cover plait that makes splicing easier. Abrasion resistant 32 plaited Polyester kink-free cover.



Code	ø mm	Code	daN	Meters	UM	€
3143506200	6	RED	1200	200	PCK	
3143508200	8	RED	2300	200	PCK	
3143510200	10	RED	3100	200	PCK	
3143512200	12	RED	4800	200	PCK	
3143514150	14	RED	6500	150	PCK	
3143606200	6	BLUE	1200	200	PCK	
3143608200	8	BLUE	2300	200	PCK	
3143610200	10	BLUE	3100	200	PCK	
3143612200	12	BLUE	4800	200	PCK	
3143614150	14	BLUE	6500	150	PCK	
3143706200	6	YELLOW	1200	200	PCK	
3143708200	8	YELLOW	2300	200	PCK	
3143710200	10	YELLOW	3100	200	PCK	
3143712200	12	YELLOW	4800	200	PCK	
3143714150	14	YELLOW	6500	150	PCK	
3143406200	6	GREEN	1200	200	PCK	
3143408200	8	GREEN	2300	200	PCK	
3143410200	10	GREEN	3100	200	PCK	
3143412200	12	GREEN	4800	200	PCK	
3143414150	14	GREEN	6500	150	PCK	

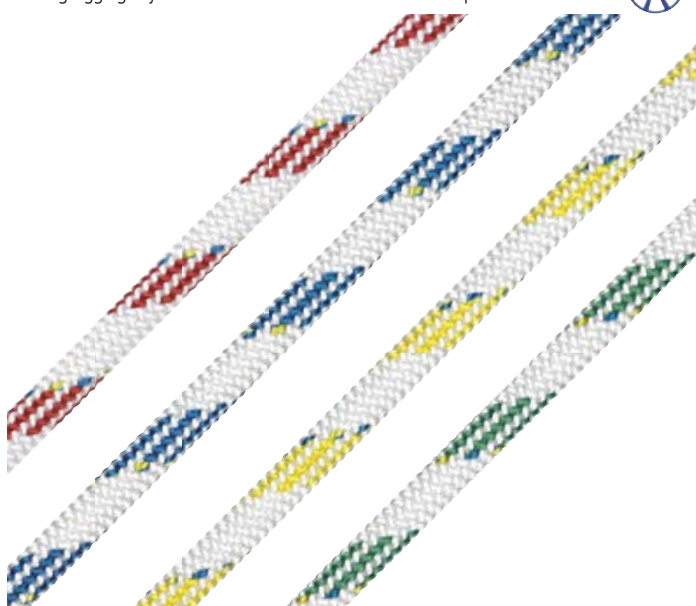

Liros Dynamic Plus Color

Low stretch (<2%) halyard/sheet. Lightweight, soft and high performance line for all type of running rigging. Dyneema SK78 core with additional cover plait that makes splicing easier. Abrasion resistant 32 plaited Polyester kink-free cover.



Code	ø mm	Colour	daN	Meters	UM	€
3147506200	6	RED	1200	200	PCK	
3147508200	8	RED	2300	200	PCK	
3147510200	10	RED	3100	200	PCK	
3147512200	12	RED	4800	200	PCK	
3147514150	14	RED	6500	150	PCK	
3147606200	6	BLUE	1200	200	PCK	
3147608200	8	BLUE	2300	200	PCK	
3147610200	10	BLUE	3100	200	PCK	
3147612200	12	BLUE	4800	200	PCK	
3147614150	14	BLUE	6500	150	PCK	
3147706200	6	YELLOW	1200	200	PCK	
3147708200	8	YELLOW	2300	200	PCK	
3147710200	10	YELLOW	3100	200	PCK	
3147712200	12	YELLOW	4800	200	PCK	
3147714150	14	YELLOW	6500	150	PCK	
3147806200	6	STEEL GREY	1200	200	PCK	
3147808200	8	STEEL GREY	2300	200	PCK	
3147810200	10	STEEL GREY	3100	200	PCK	
3147812200	12	STEEL GREY	4800	200	PCK	
3147814150	14	STEEL GREY	6500	150	PCK	

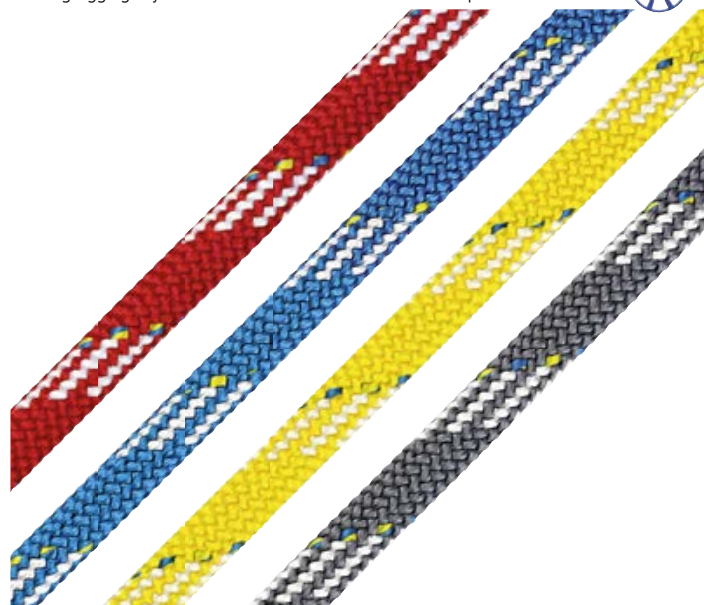

Liros Regatta 2000

Low stretch (<1,5%) and very high breaking strength halyard/sheet. Extremely resistant and lightweight line for all type of running rigging. Coated Dyneema SK78 core with additional cover plait that makes splicing easier and improves connection between core and cover. Extreme abrasion resistant High-Performance Polyester cover.



Code	ø mm	Code	daN	Meters	UM	€
3146504250	4	RED	800	250	PCK	
3146505250	5	RED	1100	250	PCK	
3146506200	6	RED	2500	200	PCK	
3146508200	8	RED	3800	200	PCK	
3146510200	10	RED	5000	200	PCK	
3146512200	12	RED	7200	200	PCK	
3146514150	14	RED	9500	150	PCK	
3146516100	16	RED	12800	100	PCK	
3146604250	4	BLUE	800	250	PCK	
3146605250	5	BLUE	1100	250	PCK	
3146606200	6	BLUE	2500	200	PCK	
3146608200	8	BLUE	3800	200	PCK	
3146610200	10	BLUE	5000	200	PCK	
3146612200	12	BLUE	7200	200	PCK	
3146614150	14	BLUE	9500	150	PCK	
3146616100	16	BLUE	12800	100	PCK	
3146704250	4	YELLOW	800	250	PCK	
3146705250	5	YELLOW	1100	250	PCK	
3146706200	6	YELLOW	2500	200	PCK	
3146708200	8	YELLOW	3800	200	PCK	
3146710200	10	YELLOW	5000	200	PCK	
3146712200	12	YELLOW	7200	200	PCK	
3146714150	14	YELLOW	9500	150	PCK	
3146716100	16	YELLOW	12800	100	PCK	
3146804250	4	WHITE	800	250	PCK	
3146805250	5	WHITE	1100	250	PCK	
3146806200	6	WHITE	2500	200	PCK	
3146808200	8	WHITE	3800	200	PCK	
3146810200	10	WHITE	5000	200	PCK	
3146812200	12	WHITE	7200	200	PCK	
3146814150	14	WHITE	9500	150	PCK	
3146816100	16	WHITE	12800	100	PCK	
3146904250	4	ORANGE	800	250	PCK	
3146905250	5	ORANGE	1100	250	PCK	
3146906200	6	ORANGE	2500	200	PCK	
3146908200	8	ORANGE	3800	200	PCK	
3146910200	10	ORANGE	5000	200	PCK	
3146912200	12	ORANGE	7200	200	PCK	
3146914150	14	ORANGE	9500	150	PCK	
3146916100	16	ORANGE	12800	100	PCK	



HARDWARE SAILING/COVERS/ROPES/FLAGS COVERINGS

Liros Racer Vision

Low stretch (<1.5%) and very high breaking strength high-tech halyard/sheet. Easy to splice, lightweight, ideal for winches and stoppers thanks to its high resistance to abrasion. Abrasion resistant 32-plait high twist SteelBlue Polyester cover. 12-plait Dyneema core with XTR grip coating.

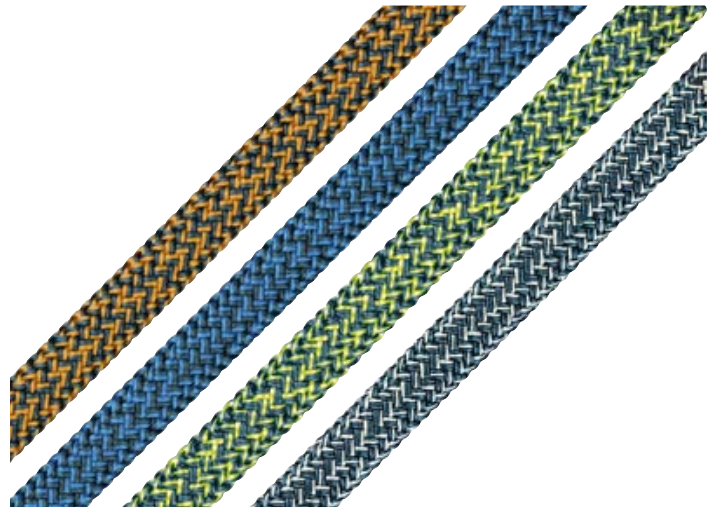

Code	ø mm	Colour	daN	Meters	UM	€
3145608200	8	ORANGE	4200	200	PCK	
3145610200	10	ORANGE	5500	200	PCK	
3145612200	12	ORANGE	8000	200	PCK	
3145614150	14	ORANGE	10500	150	PCK	
3145708200	8	BLUE	4200	200	PCK	
3145710200	10	BLUE	5500	200	PCK	
3145712200	12	BLUE	8000	200	PCK	
3145714150	14	BLUE	10500	150	PCK	
3145808200	8	YELLOW	4200	200	PCK	
3145810200	10	YELLOW	5500	200	PCK	
3145812200	12	YELLOW	8000	200	PCK	
3145814150	14	YELLOW	10500	150	PCK	
3145908200	8	SILVER	4200	200	PCK	
3145910200	10	SILVER	5500	200	PCK	
3145912200	12	SILVER	8000	200	PCK	
3145914150	14	SILVER	10500	150	PCK	

**Liros Racer-XTR**

Low stretch (<1%) and very high breaking strength halyard/sheet. Used in regattas by best racers, ideal for powerful cleats and stoppers under tension. Even at high temperature extreme abrasion resistant 32 plaited hybrid fiber cover. 12 Plaited Dyneema SK78 core with XTR grip coating.

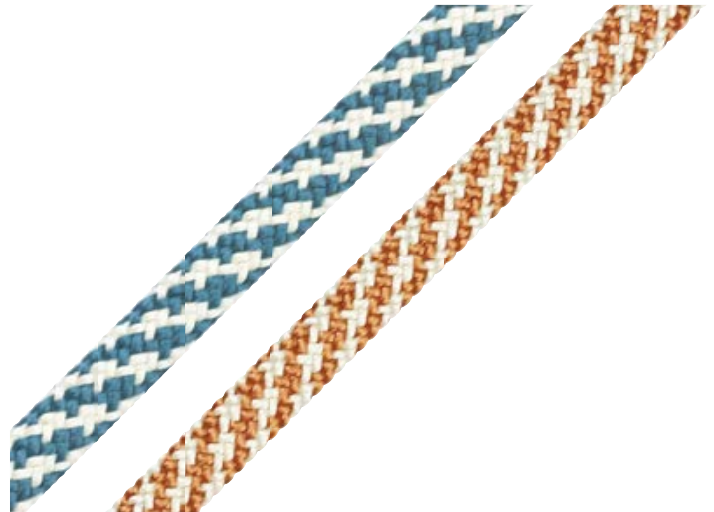

Code	ø mm	Colour	daN	Meters	UM	€
3144908200	8	WHITE/STEEL BLUE	4700	200	PCK	
3144910200	10	WHITE/STEEL BLUE	6900	200	PCK	
3144912200	12	WHITE/STEEL BLUE	9900	200	PCK	
3144914150	14	WHITE/STEEL BLUE	13000	150	PCK	
3144808200	8	WHITE/ORANGE	4700	200	PCK	
3144810200	10	WHITE/ORANGE	6900	200	PCK	
3144812200	12	WHITE/ORANGE	9900	200	PCK	
3144814150	14	WHITE/ORANGE	13000	150	PCK	

**Liros Control-XTR**

Extreme perfection and quality low stretch (<1%) line ideal for stoppers and winches. Highest grip factor, total abrasion and high temperature resistance. 32 Plaited Technora and high-tenacity Polyester cover with Aramid that blocks melting at high temperature. Pre-stretched with Liros Hss and LCS system Dyneema SK99 core with Grip Coating that ensures cover-core power transference.



Code	ø mm	Colour	daN	Meters	UM	€
3147110100	10	RED	8000	100	PCK	
3147112100	12	RED	11200	100	PCK	
3147114100	14	RED	14100	100	PCK	
3147116100	16	RED	17500	100	PCK	
3147118100	18	RED	20400	100	PCK	
3147310100	10	BLUE	8000	100	PCK	
3147312100	12	BLUE	11200	100	PCK	
3147314100	14	BLUE	14100	100	PCK	
3147316100	16	BLUE	17500	100	PCK	
3147318100	18	BLUE	20400	100	PCK	
3147010100	10	WHITE	8000	100	PCK	
3147012100	12	WHITE	11200	100	PCK	
3147014100	14	WHITE	14100	100	PCK	
3147016100	16	WHITE	17500	100	PCK	
3147018100	18	WHITE	20400	100	PCK	
3147210100	10	GREEN	8000	100	PCK	
3147212100	12	GREEN	11200	100	PCK	
3147214100	14	GREEN	14100	100	PCK	
3147216100	16	GREEN	17500	100	PCK	
3147218100	18	GREEN	20400	100	PCK	

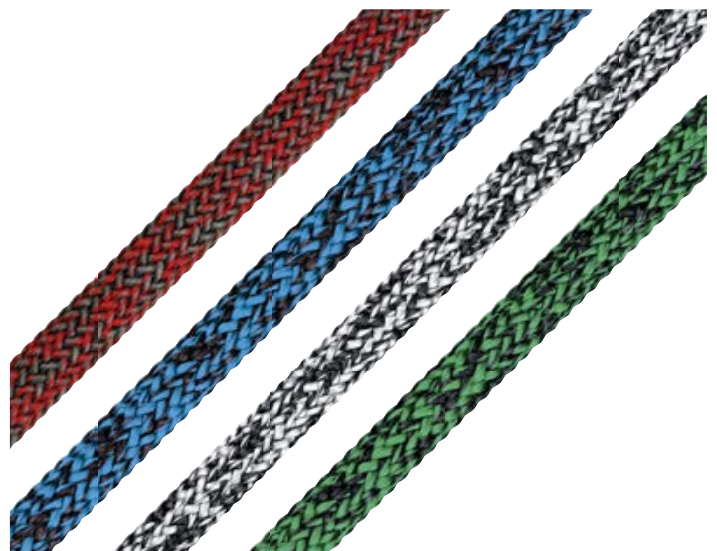

Liros Magic Edge

Performance low stretch (<1,5%) line ideal for all racing applications. Compact braiding Polyester cover for excellent abrasion resistance. Diameters 1.5 and 2 are supplied full colour without code. Dyneema SK78 core.

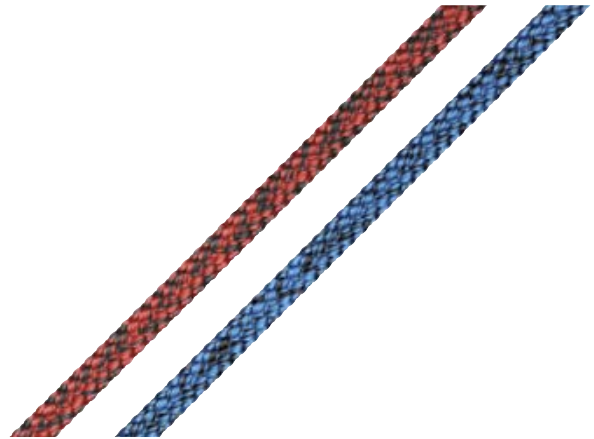

Code	ø mm	Colour	daN	Meters	UM	€
3143901100	1,5	RED	125	100	PCK	
3143902100	2	RED	240	100	PCK	
3143903100	3	RED	420	100	PCK	
3143904100	4	RED	580	100	PCK	
3143905100	5	RED	1050	100	PCK	
3143906100	6	RED	1800	100	PCK	
3144001100	1,5	BLUE	125	100	PCK	
3144002100	2	BLUE	240	100	PCK	
3144003100	3	BLUE	420	100	PCK	
3144004100	4	BLUE	580	100	PCK	
3144005100	5	BLUE	1050	100	PCK	
3144006100	6	BLUE	1800	100	PCK	

**Liros Magic Sport**

Multi purpose technical low stretch (<5%) line with Neon-Design perfect for dinghies and small sportboats. Very abrasion resistant, with high tenacity Polyester 16 plaited heat-set core.

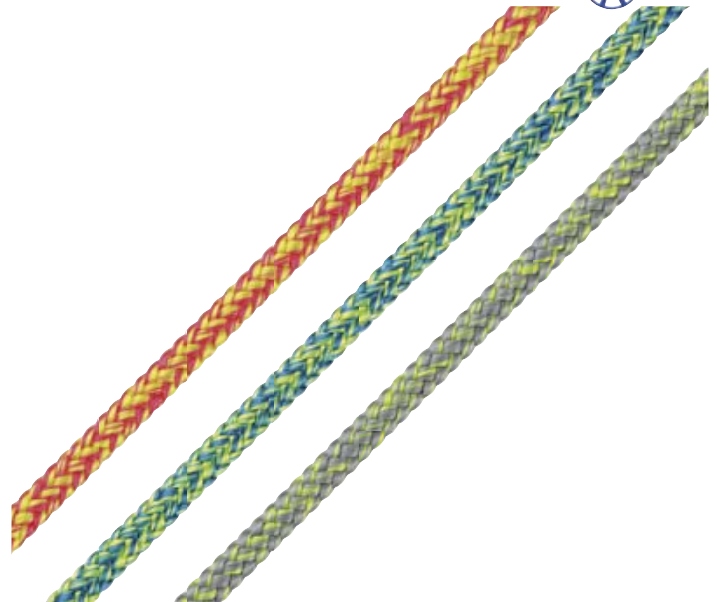

Code	ø mm	Colour	daN	Meters	UM	€
3144202100	2	RED	95	100	PCK	
3144203100	3	RED	185	100	PCK	
3144204100	4	RED	550	100	PCK	
3144205100	5	RED	850	100	PCK	
3144206100	6	RED	1000	100	PCK	
3144402100	2	BLUE	95	100	PCK	
3144403100	3	BLUE	185	100	PCK	
3144404100	4	BLUE	550	100	PCK	
3144405100	5	BLUE	850	100	PCK	
3144406100	6	BLUE	1000	100	PCK	
3144302100	2	SILVER	95	100	PCK	
3144303100	3	SILVER	185	100	PCK	
3144304100	4	SILVER	550	100	PCK	
3144305100	5	SILVER	850	100	PCK	
3144306100	6	SILVER	1000	100	PCK	

**Liros Magic Pro**

Halyard/sheet low stretch line used in regattas by dinghies and catamarans. Ensures great holding power on cleats, blocks and stoppers thanks to its high grip factor, while the grip coating core enables fast manoeuvres. High tenacity Polyester Grip cover. Dyneema SK78 core with special XTR grip coating.



Code	ø mm	Colour	daN	Meters	UM	€
3145003100	3	RED	450	100	PCK	
3145004100	4	RED	620	100	PCK	
3145005100	5	RED	1250	100	PCK	
3145006100	6	RED	1600	100	PCK	
3145008100	8	RED	3000	100	PCK	
3145103100	3	BLUE	450	100	PCK	
3145104100	4	BLUE	620	100	PCK	
3145105100	5	BLUE	1250	100	PCK	
3145106100	6	BLUE	1600	100	PCK	
3145108100	8	BLUE	3000	100	PCK	
3145203100	3	BLACK	450	100	PCK	
3145204100	4	BLACK	620	100	PCK	
3145205100	5	BLACK	1250	100	PCK	
3145206100	6	BLACK	1600	100	PCK	
3145208100	8	BLACK	3000	100	PCK	
3145303100	3	YELLOW	450	100	PCK	
3145304100	4	YELLOW	620	100	PCK	
3145305100	5	YELLOW	1250	100	PCK	
3145306100	6	YELLOW	1600	100	PCK	
3145308100	8	YELLOW	3000	100	PCK	



Liros D-Pro

Low stretch (<1%) no-cover line for extreme applications used on all type of racing boats. Lightweight, easy to splice, abrasion resistant. With a higher breaking load than a steel cable of the same diameter.

Construction of 12 plaited coated Dyneema SK78.

Code	ø mm	daN	Meters	UM	€
3145501100	1	195	100	PCK	
3145515100	1,5	230	100	PCK	
3145502100	2	410	100	PCK	
3145525100	2,5	580	100	PCK	
3145503100	3	950	100	PCK	
3145504100	4	1300	100	PCK	
3145505100	5	2600	100	PCK	
3145506100	6	4300	100	PCK	
3145508100	8	5300	100	PCK	
3145510100	10	9000	100	PCK	
3145512100	12	11900	100	PCK	

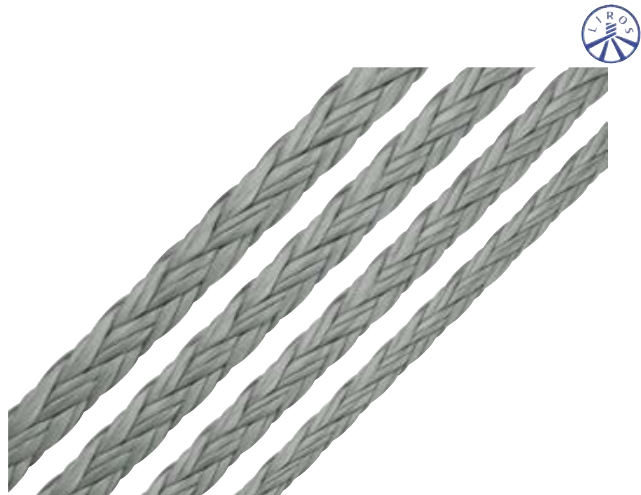

Liros Slide Protect-XTR

Additional abrasion protection line sliding cover recommended for all lines working on turning blocks and fairleads. Not suitable for stoppers and winches, the low cover grip delivers lowest friction. Construction made of 48 plaited impregnated Dyneema SK78.

Code	For Line ø mm	Meters	UM	€
3146105100	3<>6	25	PCK	
3146108100	5<>10	25	PCK	
3146112100	8<>12	25	PCK	
3146116100	14<>22	25	PCK	

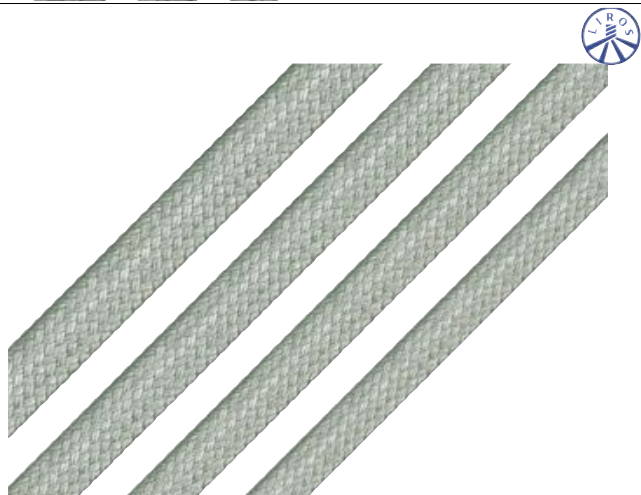

Liros Grip Protect-XTR

Additional abrasion protection line cover recommended for all lines working on stoppers and winches. The high-grip surface delivers the best in power transference inside a halyard stopper or jammer and it is the perfect solution to avoid stopper slippage. Construction made of 48 plaited Technora with Aramid that blocks melting at high temperature.

Code	For Line ø mm	Meters	UM	€
3146005100	3<>6	25	PCK	
3146008100	5<>10	25	PCK	
3146012100	8<>14	25	PCK	
3146016100	12<>22	25	PCK	

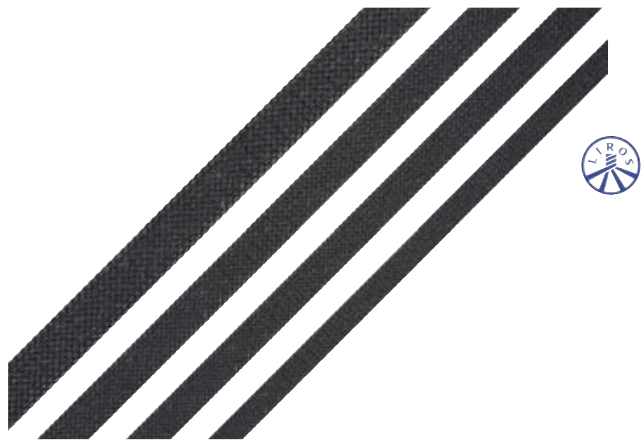

Liros Soft Shackles

Soft shackles that replace metal shackles and carabiners for connecting sheets, halyards and blocks. Also used in industrial applications. Simple, fast and safe to open with Liros lanyard, avoids injuries and deck damage. Made of high-strength Dyneema SK78, they are coloured according to breaking load in order to be easily identified.

Code	ø mm	Colour	Breaking Load Kg	UM	€
3109004	6	WHITE	1000	PCS	
3109005	8	BLACK	1500	PCS	
3109006	10	RED	2000	PCS	
3109008	12	BLUE	4000	PCS	
3109010	14	YELLOW	6000	PCS	



Liros Polyamide Braid

Abrasion resistant, flexible and elastic (<15%) multipurpose braid line. Features: 8 Plaited UV resistant high-tenacity Polyamide.



Code	ø mm	daN	m	UM	€
3104502100	2	100	100	PCK	
3104503100	3	180	100	PCK	
3104505100	5	550	100	PCK	
3104506100	6	850	100	PCK	



Multipurpose Braid

Stabilized multi-filament multipurpose braid line. Features: 8 plait 100% high quality Polyethylene.



Code	ø mm	daN	m	UM	€
3103502100	2	90	100	PCK	
3103503100	3	130	100	PCK	
3103504100	4	220	100	PCK	
3103505100	5	340	100	PCK	
3103506100	6	500	100	PCK	



Lapo Braid Line

16 Plait color coded Polyester multipurpose economical dock and anchor line. Non-floating.



Code	ø mm	daN	m	UM	€
3101504500	4	190	500	PCK	
3101505400	5	275	400	PCK	
3101506200	6	500	200	PCK	
3101508200	8	840	200	PCK	
3101510200	10	1200	200	PCK	
3101512200	12	1400	200	PCK	
3101514100	14	1600	100	PCK	



Floating Orange Braid

Resistant and light braid line for lifelines, handrails, lifebelts, temporary moorings etc. 3 plaits -100% Polyethylene. Floating.

Code	ø mm	daN	m	UM	€
3101006200	6	300	200	PCK	
3101008200	8	400	200	PCK	
3101010200	10	500	200	PCK	
3101012200	12	800	200	PCK	
3101014100	14	1100	100	PCK	
3101016100	16	1400	100	PCK	
3101018100	18	1800	100	PCK	
3101020100	20	2200	100	PCK	



Floating Black Braid

Resistant and light braid line for lifelines, handrails, lifebelts, temporary moorings etc. 3 plaits -100% Polyethylene. Floating.

Code	ø mm	daN	m	UM	€
3101206200	6	300	200	PCK	
3101208200	8	400	200	PCK	
3101210200	10	500	200	PCK	
3101212200	12	800	200	PCK	
3101214100	14	1100	100	PCK	
3101216100	16	1400	100	PCK	
3101218100	18	1800	100	PCK	
3101220100	20	2200	100	PCK	



Floating Grey Braid

Multi-filament multipurpose braid line ideal for inflatables and tenders. Soft and light, it floats, it doesn't absorb humidity. Construction: 16 plaits, 100% UV stabilized Polyethylene.

Code	ø mm	daN	m	UM	€
3101308200	8	700	200	PCK	
3101310200	10	1000	200	PCK	
3101312200	12	1300	200	PCK	
3101314150	14	1800	150	PCK	
3101316100	16	2000	100	PCK	



Rope Holder

Woven acrylic fabric rope holder. Water repellent and UV rays resistant. The indelible stabilized colors remain bright for at least 3 years of continuous use. Easy installation with velcro, it allows to tidy the ropes in a compact and fast way.

Code	Dim cm	Colour	UM	€
3215639	8 x 13	BLUE NAVY	PCS	
3215640	8 x 13	GREY	PCS	



Navishell Small Halyard Stowbag

Woven acrylic fabric halyard/sheet stowbag. Water repellent and UV rays resistant. The indelible stabilized colors remain bright for at least 3 years of continuous use. Two optional fastening system included:

- 1) With suction cups that guarantee an easy and strong fixing without holes.
- 2) With hooks that guarantee an easy and strong fixing with holes.

Code	Dim cm	H cm	Colour	UM	€
3215601	30 x 11	18	BLUE NAVY	PCS	
3215602	30 x 11	18	GREY	PCS	



Navishell Large Halyard Stowbag

Woven acrylic fabric halyard/sheet stowbag. Water repellent and UV rays resistant. The indelible stabilized colors remain bright for at least 3 years of continuous use. Two optional fastening system included:

- 1) With suction cups that guarantee an easy and strong fixing without holes
- 2) With hooks that guarantee an easy and strong fixing with holes.

Code	Dim cm	H cm	Colour	UM	€
3215604	35 x 13	24	BLUE NAVY	PCS	
3215605	35 x 13	24	GREY	PCS	



Navishell Deep Halyard Stowbag

Woven acrylic fabric halyard/sheet stowbag. Water repellent and UV rays resistant. The indelible stabilized colors remain bright for at least 3 years of continuous use. Two optional fastening system included:

- 1) With suction cups that guarantee an easy and strong fixing without holes
- 2) With hooks that guarantee an easy and strong fixing with holes.

Code	Dim cm	H cm	Colour	UM	€
3215607	36 x 10	30	BLUE NAVY	PCS	
3215608	36 x 10	30	GREY	PCS	



Navishell Halyard Rail & Cockpit Stowbag

Woven acrylic fabric halyard/sheet rail stowbag. Water repellent and UV rays resistant. The indelible stabilized colors remain bright for at least 3 years of continuous use. Three optional fastening system included:

- 1) On rails, with Velcro that guarantees an easy and strong fixing
- 2) On cockpit, with suction cups that guarantee an easy and strong fixing without holes
- 3) On cockpit, with hooks that guarantee an easy and strong fixing with holes.

Code	Dim cm	H cm	Colour	UM	€
3215610	40 x 20	28	BLUE NAVY	PCS	
3215611	40 x 20	28	GREY	PCS	



Liros Braided Polyester Lines Spools

Multicolour box of braided Polyester line spools. Extremely resistant, very flexible, UV resistant, will not stiffen up.

Code	ø mm	Pack	UM	€
3106532	2	10 x 30 m	PCK	
3106533	3	10 x 15 m	PCK	
3106534	4	5 x 10 m	PCK	



Liros Magic Speed Spools

Multicolour box of 16 plaited cover and braided Polyester core line spools. High abrasion resistant, high grip on cleats and low stretch. To be used as mini-sheets, lanyards, bindings and for other purposes.

Code	ø mm	Pack	UM	€
3105112	2	10 x 30 m	PCK	
3105113	3	10 x 15 m	PCK	



Liros Optisail Spools

16 Plaited Polyester cover and braided Dyneema SK78 core line spools. Extremely strong, low stretch (<1,5%), best knot holding.

Code	ø mm	L Meters	UM	€
3106612	1,2	20	PCS	



Polyester Multicolour Spools

Multicolor Polyester braid mini-spools. To be used as mini-sheets, lanyards, bindings and other purposes.

Code	Colour	ø mm	L m	Accessories	UM	€
3105032	YELLOW	2	30		PCS	
3105013	YELLOW	3	15		PCS	
3105232	RED	2	30		PCS	
3105213	RED	3	15		PCS	
3105432	BLUE	2	30		PCS	
3105413	BLUE	3	15		PCS	
3105632	GREEN	2	30		PCS	
3105613	GREEN	3	15		PCS	
3105031				10 Spool Display	PCS	



Dyneema Multicolour Spools

Multicolor hi-tech Dyneema-core braid mini-spools. To be used as mini-sheets, halyards, lanyards and for other purposes.

Code	Colour	ø mm	L m	Accessories	UM	€
3107001	BLUE	1	40		PCS	
3107002	BLUE	2	30		PCS	
3107003	BLUE	3	15		PCS	
3107011	RED	1	40		PCS	
3107012	RED	2	30		PCS	
3107013	RED	3	15		PCS	
3107021	YELLOW	1	40		PCS	
3107022	YELLOW	2	30		PCS	
3107023	YELLOW	3	15		PCS	
3105031				10 Spool Display	PCS	



Fullcolor Spools

Full color Polypropilene braid mini-spools. To be used as lanyards, bindings and for other purposes.



Code	Colour	ø mm	L m	Accessories	UM	€
3106032	BLUE	2	30		PCS	
3106042	BLUE with Code	2	30		PCS	
3106033	BLUE	3	15		PCS	
3106043	BLUE with Code	3	15		PCS	
3106232	RED	2	30		PCS	
3106242	RED with Code	2	30		PCS	
3106233	RED	3	15		PCS	
3106243	RED with Code	3	15		PCS	
3106332	YELLOW	2	30		PCS	
3106342	YELLOW with Code	2	30		PCS	
3106333	YELLOW	3	15		PCS	
3106343	YELLOW with Code	3	15		PCS	
3105031				10 Spool Display	PCS	



All Black Spools

Black Polyester braid mini-spools. To be used as lanyards, bindings and for other purposes.



Code	ø mm	L m	Accessories	UM	€
3105921	1	40		PCS	
3105922	2	30		PCS	
3105923	3	15		PCS	
3105031			10 Spool Display	PCS	



All White Spools

White Polyester braid mini-spools. To be used as lanyards, bindings and for other purposes.



Code	ø mm	L m	Accessories	UM	€
3105901	1	40		PCS	
3105902	2	30		PCS	
3105903	3	15		PCS	
3105031			10 Spool Display	PCS	



Outboard Motor Starting Braides

Special 16-plait braid for outboard motor starting. 100% High tensile Polyester braid.



Code	ø mm	L m	UM	€
3104035	3	100	PCK	
3104040	4	100	PCK	
3104050	5	100	PCK	



Speargun Spools

Special 16-plait braid for spearguns. Features: 100% high tensile Polyester braid.



Code	ø mm	L m	UM	€
3104215	1,5	40	PCS	
3104220	2,0	40	PCS	



Fusion Cutter

220V 60W electric rope cutter for rope and braid heat cutting. Suitable also for sails, awnings, belts, tapes and synthetic canvas cutting.

Code	Ref	UM	€
3190001	Rope Cutter	PCS	
3190002	Replacement Blade	PCS	



Pro Fusion Cutter

220V - 120W professional continuous duty electric rope cutter. Reaches 500°C in few seconds and cuts quickly even big diameter ropes, braids and cords. It cools immediately thanks to the air-cooling system. Suitable also for cutting of sails, awnings, belts, tapes and any synthetic canvas. Complete with blade, cleaning brush and 3 m power cord. Comes with portable tool box.

Code	Ref	UM	€
3190005	Rope Cutter	PCS	
3190002	Replacement Blade	PCS	
3190006	Belt Cutter Accessory Blade	PCS	



Battery Fusion Cutter

Portable cordless rechargeable battery electric rope cutter. Reaches 400°C in few seconds and cuts quickly even big diameter ropes, braids and cords. Suitable also for cutting of sails, awnings, belts, tapes and any synthetic canvas. Complete with blade, cleaning brush, rechargeable battery and charger. Comes with portable tool box.

Code	Ref	UM	€
3190003	Rope Cutter	PCS	
3190002	Replacement Blade	PCS	
3190006	Belt Cutter Accessory Blade	PCS	
3190004	Replacement Battery	PCS	



Kevlar and Dyneema Shears

Ropes cutter shears with special Carbon alloy Steel serrated blades ideal to cut Dyneema ropes, Kevlar and all tough type textile canvas.

Code	UM	€
3191090	PCS	



Liros Rigger Bag Splicing Kit

Rigger bag splicing kit with all splicing tools and accessories needed to work on all known ropes. Perfect for both professional and do-it-yourself users.

Code	UM	€
3191006	PCK	



Stainless Steel Hollow Fids

Stainless Steel hollow fids with wood handle used to gently open the strands of lines.

Code	L cm	UM	€
5830701	17,5	PCS	
5830702	26,5	PCS	



Splicing Set

Stainless Steel 4 pieces needle set for splicing. Needles length mm: 120/140/180/220. Respective diameters mm: 5/7/9/12.

Code	UM	€
3191000	PCK	



Liros Splicer Pro Needles

304 Steel needles perfect for all core-cover splices.

Code	Size	Splice mm	L cm	UM	€
3191008	Small	6-8	15	PCK	
3191009	Medium	10-12	30	PCK	
3191010	Large	12-18	34	PCK	



Whipping-Twine Polyester Waxed

Waxed Polyester white whipping twine.

Code	ø mm	Meters	UM	€
3100525	0,5	80	PCS	
3101023	1,0	30	PCS	
3101523	1,5	20	PCS	



Whipping-Twine Colour Polyester Waxed

Waxed Polyester coloured whipping twine.

Code	Colour	ø mm	Meters	UM	€
3101122	BLUE	1,5	20	PCS	
3101222	BLACK	1,5	20	PCS	



Dyneema Whipping Twine

Waxed Dyneema Carbon grey whipping twine.

Code	ø mm	Meters	UM	€
3101025	1,2	30	PCS	



White Plastic Thimbles

White Nylon thimbles that prevent wear on ropes and wires.

Code	Rope ø mm	UM	€
5430004	4	PCS	
5430005	5	PCS	
5430006	6	PCS	
5430008	8	PCS	
5430010	10	PCS	
5430012	12	PCS	
5430014	14	PCS	
5430016	16	PCS	
5430018	18	PCS	
5430020	20	PCS	
5430022	22	PCS	
5430024	24	PCS	



Stainless Steel Thimbles

AISI 316 Stainless Steel thimbles. Prevent wear on ropes and wires.

Code	Rope ø mm	UM	€
5425001	2	PCS	
5425002	2,5	PCS	
5425003	3	PCS	
5425004	4	PCS	
5425005	5	PCS	
5425006	6	PCS	
5425008	8	PCS	
5425010	10	PCS	
5425012	12	PCS	
5425014	14	PCS	
5425016	16	PCS	
5425018	18	PCS	
5425020	20	PCS	
5425022	22	PCS	
5425024	24/26	PCS	
5425028	28/30	PCS	
5425032	32/34	PCS	
5425036	36/38	PCS	
5425040	40/42	PCS	



Aluminum Oval Sleeves

Oval Anodized Aluminum sleeves for splicing.

Code	Rope ø mm	UM	€
5424503	3	PCS	
5424504	4	PCS	
5424505	5	PCS	
5424506	6	PCS	
5424508	8	PCS	
5424510	10	PCS	
5424512	12	PCS	
5424514	14	PCS	



Copper Oval Sleeves

Copper oval sleeves for splicing.

Code	Rope ø mm	UM	€
5424002	2	PCS	
5424003	3	PCS	
5424004	4	PCS	
5424005	5	PCS	
5424006	6	PCS	
5424008	8	PCS	



Thermic Rope Ends

Thermic constricting unravelling rope ends.

6 pieces pack.

Code	Rope ø mm	Pack	UM	€
3191012	6,5<>12,5	6 Pcs	PCK	
3191018	10<>19	6 Pcs	PCK	

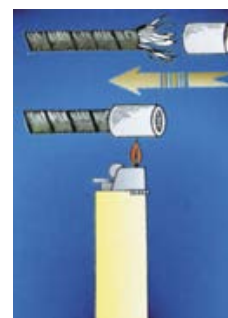

- SAIL REPAIRS -

Sailing Thread Cutter

Thread cutter for sails, sacks and fabrics.

Code	Length mm	UM	€
3191071	85	PCS	
3191072	130	PCS	



Thread Scissors

Thread scissors.

Code	Length mm	UM	€
3191080	110	PCS	



Polyester Sewing Thread

Polyester white sewing thread.

Code	ø mm	Meters	UM	€
3100350	0,3	140	PCS	



Sail Repair Set

Waterproof box including:

- 5 Needles
- 1 Hand sewing protection
- 1 mm x 50 m Waxed thread
- 1 Quick repair tape.

Code	UM	€
3191005	PCK	



Sail Needle Set

Needles for repairing sails, biminis and covers.

Code	Needle 1 L mm	Needle 2 L mm	Needle 3 L mm	Needle 4 L mm	Needle 5 L mm	Needle 6 L mm	UM	€
3191050	40 (Bent)	50 (Bent)	75 (Bent)				PCK	
3191052	40 (Straight)	50 (Straight)	60 (Straight)	100 (Straight)	75 (Bent)		PCK	
3191054	40 (Straight)	75 (Straight)	125 (Straight)	150 (Straight)	200 (Straight)	75 (Bent)	PCK	



Spinnaker Ripstop Tape

Very lightweight but strong Ripstop Spinnaker Tape for light sails and spi rapid repairs.

Code	L m	H mm	Colour	UM	€
5720407	4.5	50	RED	PCS	
5720408	4.5	50	WHITE	PCS	
5720409	4.5	50	GREEN	PCS	
5720410	4.5	50	BLACK	PCS	
5720411	4.5	50	YELLOW	PCS	
5720412	4.5	50	BLUE	PCS	
5720413	4.5	50	LIGHT BLUE	PCS	
5720414	4.5	50	ORANGE	PCS	
5720415	4.5	50	PINK	PCS	
5720417	4.5	50	Fluo ORANGE	PCS	
5720418	4.5	50	Fluo GREEN	PCS	
5720419	4.5	50	Fluo YELLOW	PCS	



Sail MainTape

Extra strong and sturdy Maintape tape for quick repair of all type of sails.

Code	L m	H mm	Colour	UM	€
5720430	1.5	100	WHITE	PCS	
5720431	1.5	100	BLUE	PCS	
5720432	1.5	100	RED	PCS	



Mylar Tape

Mylar Tape ideal to repair the clear parts of sails and tents.

Code	L m	H mm	UM	€
5720440	3	50	PCS	
5720441	3	100	PCS	



Kevlar Tape

Kevlar Tape specific designed to repair Kevlar sails.

Code	L m	H mm	UM	€
5720445	1.5	50	PCS	



White Shock Cord

High quality long lasting White elastic shock cord.

Code	ø mm	m	UM	€
317003100	3	100	PCK	
317004100	4	100	PCK	
317005100	5	100	PCK	
317006100	6	100	PCK	
317008100	8	100	PCK	
317010100	10	100	PCK	
3170012100	12	100	PCK	

**Black Shock Cord**

High quality long lasting Black elastic shock cord.

Code	ø mm	m	UM	€
3170104100	4	100	PCK	
3170105100	5	100	PCK	
3170106100	6	100	PCK	
3170108100	8	100	PCK	
3170110100	10	100	PCK	

**White Shock Cord Hook**

Shock cord hook.

Code	Shock Cord ø mm	UM	€
0332804	4	PCS	
0332805	5*	PCS	
0332806	6	PCS	
0332808	8	PCS	
0332810	10	PCS	

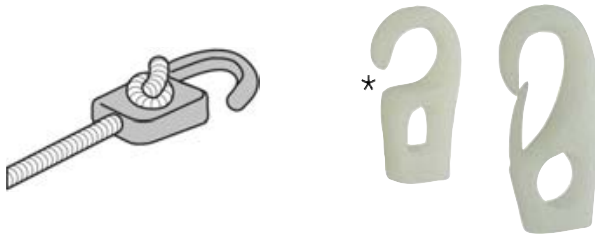
**Black Shock Cord Hooks**

Shock cord hook.

Code	Shock Cord ø mm	UM	€
0332704	4	PCS	
0332705	5*	PCS	
0332706	6	PCS	
0332708	8	PCS	
0332710	10	PCS	

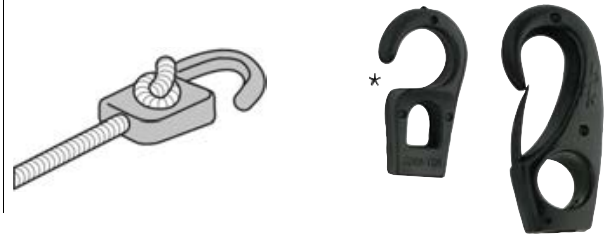
**Stainless Steel Shock Cord Hook**

Shock cord hook.

Code	Shock Cord ø mm	UM	€
0332816	6	PCS	
0332818	8	PCS	
0332820	10	PCS	

**Flat Hooks for Shock cords**

Tarpaulin fixing hooks for inflatables. 10 pcs packs.

Code	Colour	Shock Cord ø mm	UM	€
0332600	BLACK	6/8	PCS	
0332610	WHITE	6/8	PCS	
0332620	GREY	6/8	PCS	

**White Automatic Shock Cord Hooks**

Automatic shock cord hooks system.

Code	Shock Cord ø mm	UM	€
0332843	5<>6	PCS	
0332844	8	PCS	

**Black Automatic Shock Cord Hooks**

Automatic shock cord hooks system.

Code	Shock Cord ø mm	UM	€
0332840	5<>6	PCS	
0332842	8	PCS	

**Autoblock Shock Cord Clips**

Auto-locking shock cord clips system.

Code	Colour	Shock Cord ø mm	UM	€
0332835	BLUE	5<>6	PCS	
0332836	BLACK	5<>6	PCS	

**Hoggrings for Shock Cords**

Hoggrings for shock cords. 100 pcs packs.

Code	Shock Cord ø mm	UM	€
3175004	4	PCK	
3175006	5<>6	PCK	
3175008	8	PCK	
3175010	10	PCK	



2 Nylon Hooks Shock Cords

2 Classic hooks shock cords.

Code	cm	ø mm	Pack/Pcs	UM	€
3172420	20	4	20	PCS	
3172430	30	4	20	PCS	
3172630	30	6	20	PCS	
3172650	50	6	20	PCS	
3172850	50	8	20	PCS	
3173010	100	10	20	PCS	

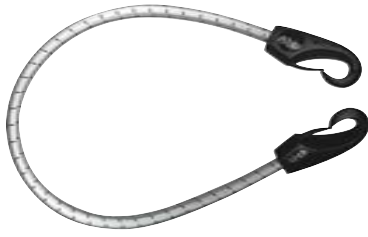
**2 Stainless Steel Hooks Shock Cords**

Stainless Steel 2 hooks shock cords.

Code	cm	ø mm	Pack/Pcs	UM	€
3173630	30	6	20	PCS	
3173850	50	8	20	PCS	
3173880	80	8	20	PCS	
3174075	80	10	20	PCS	
3174110	100	10	20	PCS	

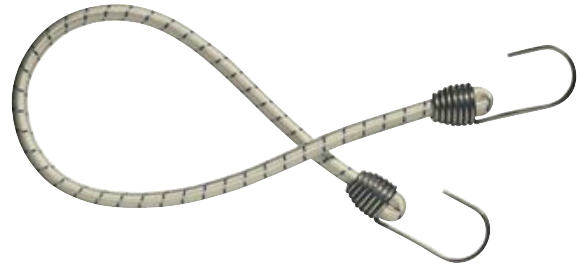
**1 Nylon Hook Shock Cord**

1 Classic hook shock cord.

Code	cm	ø mm	Pack/Pcs	UM	€
3174520	20	4	20	PCS	
3174535	35	4	20	PCS	
3174555	55	4	20	PCS	

**Auto-Lock Shock Cord**

Auto-lock system shock cord.

Code	cm	ø mm	Pack/Pcs	UM	€
3175550	50	5	20	PCS	
3175670	70	6	20	PCS	

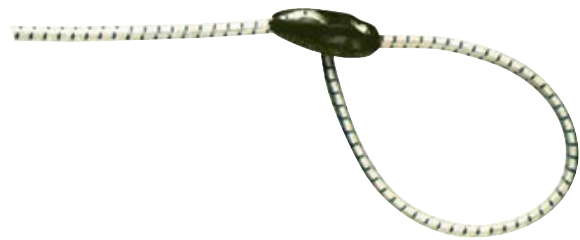
**Sail Gaskets Shock Cord**

Sail gaskets shock cord.

Code	cm	ø mm	Pack/Pcs	UM	€
3175830	30	4	20	PCS	
3175840	40	4	20	PCS	
3175850	50	4	20	PCS	

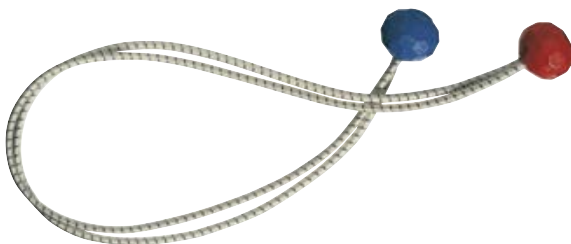
**Hollow Fid Shock Cord**

Shock cord with hollow fid.

Code	L cm	ø mm	UM	€
3175935	35	6	PCS	
3175955	55	6	PCS	
3175975	75	6	PCS	

**Sail Centipede**

Multiple ends shock cord which fixes the mainsail to the boom.

Code	cm	ø mm	UM	€
3176020	200	8	PCS	
3176030	300	8	PCS	
3176130	300	10	PCS	

**Navishell Sail Tie**

Woven acrylic fabric sail tie. Water repellent and UV rays resistant. It contains an elastic for facilitating the application. The package contains 3 pieces.

Code	Sail ø cm	UM	€
3175925	23<->33	PCK	
3175926	27<->47	PCK	
3175927	37<->58	PCK	

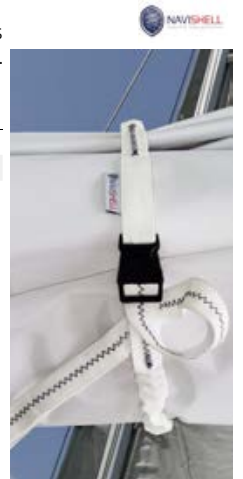

Heavy-Duty Blue Belts

Blue Polypropylene belts for nautical use. Sold in reels.

Code	H mm	Length m	UM	€
315000150	25	50	PCK	
315000250	30	50	PCK	
315000350	40	50	PCK	

**Heavy-Duty Black Belts**

Black Polypropylene belts for nautical use. Sold in reels.

Code	H mm	Length m	UM	€
315010150	25	50	PCK	
315010250	30	50	PCK	
315010350	40	50	PCK	

**Heavy-Duty White Belts**

White Polypropylene belts for nautical use. Sold in reels.

Code	H mm	Length m	UM	€
315020150	25	50	PCK	
315020250	30	50	PCK	
315020350	40	50	PCK	

**Heavy-Duty Red Belts**

Red Polypropylene belts for nautical use. Sold in reels.

Code	H mm	Length m	UM	€
315030150	25	50	PCK	
315030250	30	50	PCK	
315030350	40	50	PCK	

**Liros Dyneema Webbing Belt**

Multi-purpose Dyneema SK78 belt with very high breaking load. Low stretching, exceptionally abrasion resistant, no water absorbing and UV resistant.

Code	H mm	Length m	Breaking Load Kg	UM	€
315102550	25	50	1800	PCK	

**Single Inlet Buckle for Belts**

Stainless Steel single inlet buckle for belts.

Code	Dim mm	Passage mm	UM	€
3180100	65 x 40	50	PCS	

**Double Inlet Buckle for Belts**

Stainless Steel double inlet buckle for belts.

Code	Dim mm	Passage mm	UM	€
3180101	62 x 34	50	PCS	
3180102	35 x 25	26	PCS	





Stainless Steel Cargo Anchoring Belt

Anchoring belt with high tenacity Polyester strap and Stainless Steel buckle. Ideal for securing light loads up to 250 Kg on boats, bridges, holds, trolleys and vehicles. CE marked according to EN 12195-2.

Code	H mm	L m	Breaking Load Kg	UM	€
3180026	25	2,5	250	PCS	
3180041	25	4	250	PCS	

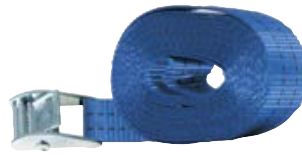

Standard Ratchet Strap

Ratchet Strap with high tenacity Polyester belt and Iron-Cadmium ratchet. Ideal for lashing any load on boats, bridges, holds, trolleys and vehicles. CE marked according to EN 12195-2.

Code	H mm	L m	Breaking Load Kg	UM	€
3180400	25	3	1500	PCS	
3180401	25	6	1500	PCS	
3180404	35	6	2000	PCS	
3180408	50	8,5	5000	PCS	



Standard Ratchet Strap with Hook

Ratchet strap with high tenacity Polyester belt and Iron-Cadmium ratchet and hooks. Ideal for lashing any load on boats, bridges, holds, trolleys and vehicles. CE marked according to EN 12195-2.

Code	H mm	L cm	Breaking Load Kg	UM	€
3180402	25	6	400	PCS	
3180403	35	6	1000	PCS	
3180406	50	8,5	2500	PCS	

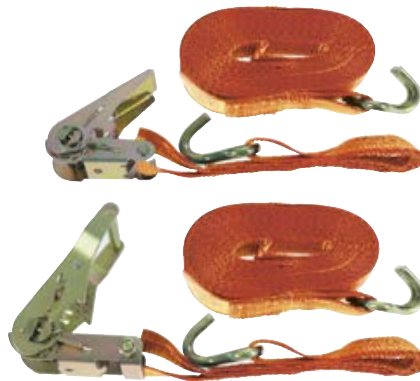

Stainless Steel Ratchet Strap

Ratchet strap with high tenacity Polyester belt and Stainless Steel ratchet. Ideal for lashing any load on boats, bridges, holds, trolleys and vehicles. CE marked according to EN 12195-2.

Code	H mm	L m	Breaking Load Kg	UM	€
3180425	25	6	600	PCS	
3180435	35	6	900	PCS	



Stainless Steel Ratchet Strap with Hook

Ratchet strap with high tenacity Polyester belt and Stainless Steel ratchet and hooks. Ideal for lashing any load on boats, bridges, holds, trolleys and vehicles. CE marked according to EN 12195-2.

Code	H mm	L m	Breaking Load Kg	UM	€
3180462	25	6	400	PCS	
3180464	35	6	750	PCS	



AA Winch Handle Holder

Soft PVC UV resistant winch handle holder with drain hole.

Code	Dim cm	UM	€
3840030	8,5 x 6 x H25	PCS	
3840035	9 x 6 x H28,5	PCS	

**Navishell Winch Handle Pocket**

Water repellent UV rays resistant acrylic fabric Navishell winch handle pocket. The indelible colours do not fade and remain intense even after 3 years of continuous use. Two optional fastening systems included:

- 1) Suction cups that guarantee an easy and strong fixing with no need to drill
- 2) Hooks that guarantee an easy and even stronger fixing with holes.

Code	Dim cm	Colour	UM	€
3215619	25 x 12 x 8	BLUE NAVY	PCS	
3215620	25 x 12 x 8	GREY	PCS	



NAVISHELL

Navishell Winch Cover

Water repellent UV rays resistant acrylic fabric Navishell winch cover. The indelible colours do not fade and remain intense even after 3 years of continuous use.

Code	Colour	For Winch H x ø cm	UM	€
3215622	BLUE NAVY	25 x 17	PCS	
3215625	BLUE NAVY	27 x 18,7	PCS	
3215628	BLUE NAVY	29 x 21,3	PCS	
3215623	GREY	25 x 17	PCS	
3215626	GREY	27 x 18,7	PCS	
3215627	GREY	29 x 21,3	PCS	



NAVISHELL

Winch Cover Fendress Soft

Fleeced and soft acrylic canvas superior quality winch cover caps. Resistant to UV rays and salt water. Colors and features remain unaltered. Protects the winch making it breathe without creating condensation.

Code	Colour	Size	For Winch H x ø cm	UM	€
3215559	BLUE NAVY	Small	16 x 14	PCS	
3215560	BLUE NAVY	Medium	18 x 17	PCS	
3215561	BLUE NAVY	Large	22 x 18	PCS	
3215559WN	RED WINE	Small	16 x 14	PCS	
3215560WN	RED WINE	Medium	18 x 17	PCS	
3215561WN	RED WINE	Large	22 x 18	PCS	
3215559BR	BLUE ROYAL	Small	16 x 14	PCS	
3215560BR	BLUE ROYAL	Medium	18 x 17	PCS	
3215561BR	BLUE ROYAL	Large	22 x 18	PCS	
3215559BK	BLACK	Small	16 x 14	PCS	
3215560BK	BLACK	Medium	18 x 17	PCS	
3215561BK	BLACK	Large	22 x 18	PCS	
3215559SA	SAND	Small	16 x 14	PCS	
3215560SA	SAND	Medium	18 x 17	PCS	
3215561SA	SAND	Large	22 x 18	PCS	
3215559SG	LIGHT GREY	Small	16 x 14	PCS	
3215560SG	LIGHT GREY	Medium	18 x 17	PCS	
3215561SG	LIGHT GREY	Large	22 x 18	PCS	



Fendress

Fendboard Outboard Cover

Premium quality outboard covers, made of the same fabric which is used for soft and sturdy Fendress fender covers. Protects from rubbing wear, from weathering, bumps, scratches, UV rays and it might even be left on the outboard while cruising. Fendboard Covers are made of breathable fabric (do not create condensation) and do not fade. Machine wash and quick drying. With the Fendboard cover your outboard motor will remain as new for longer.

Code	Colour	Dimensions cm	Size	For Outboard HP	UM	€
3270801	BLUE NAVY	36x20x20	S	2<5	PCS	
3270802	BLUE NAVY	40x20x25	M	9.9<15	PCS	
3270803	BLUE NAVY	60x35x35	L	25<150	PCS	
3270804	BLUE NAVY	60x50x50	XL	200>	PCS	
3270801WN	RED WINE	36x20x20	S	2<5	PCS	
3270802WN	RED WINE	40x20x25	M	9.9<15	PCS	
3270803WN	RED WINE	60x35x35	L	25<150	PCS	
3270804WN	RED WINE	60x50x50	XL	200>	PCS	
3270801BR	BLUE ROYAL	36x20x20	S	2<5	PCS	
3270802BR	BLUE ROYAL	40x20x25	M	9.9<15	PCS	
3270803BR	BLUE ROYAL	60x35x35	L	25<150	PCS	
3270804BR	BLUE ROYAL	60x50x50	XL	200>	PCS	
3270801BK	BLACK	36x20x20	S	2<5	PCS	
3270802BK	BLACK	40x20x25	M	9.9<15	PCS	
3270803BK	BLACK	60x35x35	L	25<150	PCS	
3270804BK	BLACK	60x50x50	XL	200>	PCS	
3270801SA	SAND	36x20x20	S	2<5	PCS	
3270802SA	SAND	40x20x25	M	9.9<15	PCS	
3270803SA	SAND	60x35x35	L	25<150	PCS	
3270804SA	SAND	60x50x50	XL	200>	PCS	
3270801SG	LIGHT GREY	36x20x20	S	2<5	PCS	
3270802SG	LIGHT GREY	40x20x25	M	9.9<15	PCS	
3270803SG	LIGHT GREY	60x35x35	L	25<150	PCS	
3270804SG	LIGHT GREY	60x50x50	XL	200>	PCS	

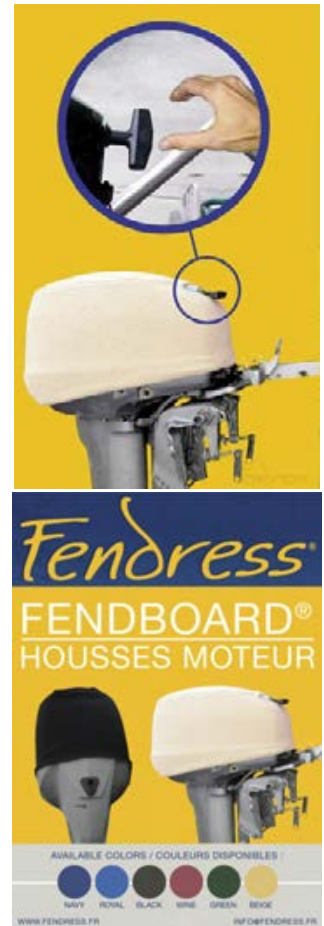

Fendress

**Silver Shield Outboard Top Covers**

Premium quality top outboard covers made of 100% waterproof Polyester 420D PVC coated fabric. UV resistant thanks to the silver colour which reflects the sunlight. Endowed with inner elastic belt to suit perfectly on outboard shape.

Code	L cm	W cm	H cm	Size	UM	€
3270105	40	25	30	XXS	PCS	
3270106	48	27	33	XS	PCS	
3270107	55	33	42	S	PCS	
3270108	63	35	48	M	PCS	
3270109	73	40	65	L	PCS	
3270110	75	45	75	XL	PCS	
3270111	90	60	80	XXL	PCS	

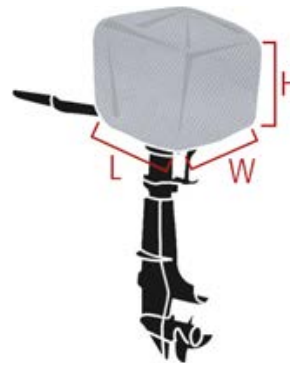
**Silver Shield Outboard Covers**

Premium quality outboard covers made of 100% waterproof Polyester 420D PVC coated fabric. UV resistant thanks to the silver colour which reflects the sunlight.

Code	L cm	W cm	H cm	A cm	Size	UM	€
3270101	25	25	110	25	S	PCS	
3270102	50	30	135	70	M	PCS	
3270103	125	45	210	110	L	PCS	

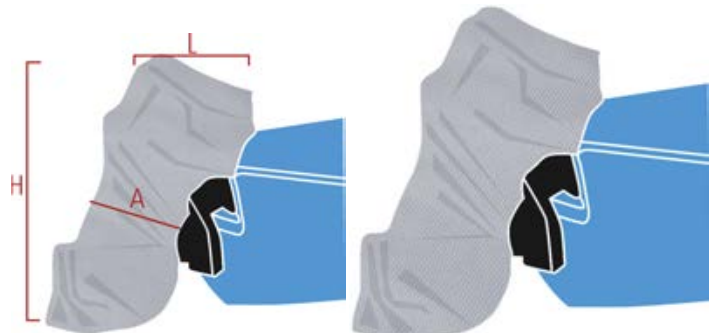

Silver Shield Boat Covers

Premium quality boat covers made of 100% waterproof Polyester PVC coated fabrics. UV Resistant, they reflect sunlight thanks to the silver colour (except XL-XXL-XXXL sizes' blue colour). Endowed with inner elastic belt to suit perfectly on boat's shape and with double seaming for the best durability. The D anti-scratch rings and rope both ensures safe fastening.



Code	Boat L cm	Max Boat Width cm	Canvas	Size	UM	€
3270000	240<>300	150	Polyester 300D	TENDER	PCS	
3270001	300<>360	150	Polyester 300D	TENDER	PCS	
3270002	427<>488	180	Polyester 300D	XXS	PCS	
3270003	427<>488	229	Polyester 300D	XS	PCS	
3270004	488<>564	239	Polyester 300D	S	PCS	
3270005	518<>579	244	Polyester 300D	M	PCS	
3270006	550<>610	265	Polyester 300D	L	PCS	
3270007	580<>650	295	Polyester 600D	XL	PCS	
3270008	630<>710	380	Polyester 600D	XXL	PCS	
3270009	700<>780	400	Polyester 600D	XXXL	PCS	

**Silver Shield Console Covers**

Premium quality console covers made of 100% waterproof Polyester 420D PVC coated fabric. UV resistant thanks to the silver colour which reflects the sunlight. Endowed with inner elastic belt to suit perfectly on console's shape.

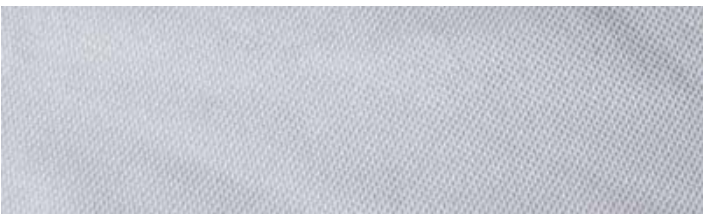

Code	A cm	B cm	C cm	D cm	Size	UM	€
3270201	115	90	45	55	XS	PCS	
3270202	90	65	75	85	S	PCS	
3270203	120	105	70	65	M	PCS	
3270204	140	100	90	70	L	PCS	
3270205	140	100	90	90	XL	PCS	

**Silver Shield Seat Cover**

Premium quality seat cover made of 100% waterproof Polyester 420D PVC coated fabric. UV resistant thanks to the silver colour which reflects the sunlight. Endowed with inner elastic belt to suit perfectly on any seat.



Code	UM	€
3270210	PCS	



Cover Modular Pole

Reinforced ABS boat cover modular support pole.

Code	H cm	UM	€
3269710	30<>140	PCS	

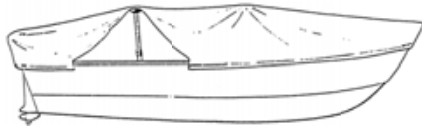
**Cover Telescoping Poles**

Boat cover telescopic support poles.

Code	H cm	UM	€
3269701	58<>102	PCS	
3269702	86<>150	PCS	
3269703	108<>200	PCS	

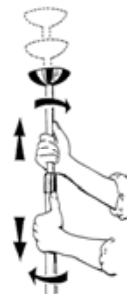
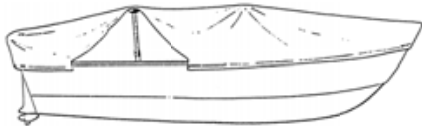
**Boat Cover Dock Edge Bow**

Reinforced Fiberglass flexible modular bow for holding up boat covers. Made of 2 pole plates to be connected together in order to reach the wanted length.

Code	L cm	L max cm	UM	€
3269718	2 x 91	183	PCS	
3269724	2 x 122	244	PCS	



DOCK EDGE

Hold-on Grip Blocking System

Nylon Hold-on grip cover blocking system. Composed of 2 parts, one of them is wedged: the more it pulls the fabric, the stronger is its blocking force. 10 pieces packs.

Code	Dim mm	Cover Thickness mm	UM	€
3214303	40 x 35 x 10	0<>2	PCS	
3214305	73 x 38 x 18	1,5<>5	PCS	

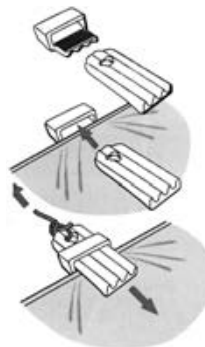
**Kraken Grip Blocking System**

Suction cap Kraken Grip cover blocking system with elastic. No need to make a hole into the boat. 6 pcs packs.

Code	ø mm	Elastic L mm	UM	€
3214800	90	200	PCS	



Zippers

Marine zippers with slider and terminals. Width: 42 mm.

Code	cm	UM	€
3216010	100	PCS	
3216015	150	PCS	
3216020	200	PCS	
3216025	250	PCS	
3216030	300	PCS	

**Meter Continuous Zip**

Continuous belt zipper to be cut as needed. Width: 42 mm. Slider sold separately.

Code	Ref	UM	€
3216001	100 m Reel	PCK	
3216002	Slider	PCS	

**Velcro Pulling Tapes**

Velcro pulling tapes suitable for fabrics. Male + female.

Code	W mm	L m	UM	€
3215000	25	25	PCK	
3215001	40	25	PCK	

**Velcro Pulling Disks**

Velcro pulling male+female disks suitable for fabrics.

Code	ø mm	Pieces	UM	€
3215005	25	10 Pairs	PCK	
3215006	45	5 Pairs	PCK	

**3M Blister Dual Lock Resealable Strips**

3M Dual Lock self-adhesive resealable fastening system with VHB acrylic adhesive. Unlike the velcro, it resists thousands of openings with a superior holding strength. Ideal for fixing large and small items, even heavy ones. Blister packs of 2 strips.

Code	Colour	Dim mm	UM	€
3215020	CLEAR	25 x 76	PCK	
3215021	BLACK	25 x 76	PCK	

**3M Dual Lock Mini Pack Resealable Tape**

3M Dual Lock self-adhesive resealable fastening system with VHB acrylic adhesive. Unlike the velcro, it resists thousands of openings with a superior holding strength. Ideal for covers, biminis, fabrics, closures, thermal bags ecc.

Code	W mm	L m	UM	€
3215012	25	5	PCS	

**3M Scotchmate Mini Pack Velcro Tape**

3M Scotchmate velcro self-adhesive fastening system with resin rubber adhesive. Ideal for covers, biminis, fabrics, closures, thermal bags ecc.

Code	W mm	L m	UM	€
3215010	25	5	PCS	



Lashing Buttons

Plastic body lashing buttons. 100 pcs packs.

Code	H mm	Hole ø mm	Colour	Pcs	UM	€
3211610	10	3,8	BLACK	100	PCK	
3211613	10	3,8	WHITE	100	PCK	

**Finishing Washers**

Plastic body finishing washers. 100 pcs packs.

Code	ø mm	Colour	Pcs	UM	€
3211804	4,5	BLACK	100	PCK	
3211805	5,5	BLACK	100	PCK	
3211904	4,5	WHITE	100	PCK	
3211905	5,5	WHITE	100	PCK	

**Finishing Washers with Cap**

Plastic body finishing washers with press-on caps. 100 pcs packs.

Code	For Screw ø mm	Pcs	UM	€
3211703	3,5<4,2	100	PCK	
3211705	4,8<6,0	100	PCK	

**Plastic Eyelets Set**

Plastic eyelets. It mounts with a simple hammer strike. Inner dia 15 mm / outer dia 35 mm. 12 pcs packs.

Code	Colour	Pcs	UM	€
3211514	BLUE	12	PCK	
3211614	WHITE	12	PCK	

**Brass-Nickel Plated Eyelets**

Chromed Brass plated eyelets. To be mounted with press tools.

Code	Inner ø mm	Outer ø mm	Pieces	UM	€
3211108	8	15	1000	PCK	
3211110	10	19	1000	PCK	
3211112	12	22	1000	PCK	
3211115	15	24	1000	PCK	

**Canvas Eyelets Blister**

Eyelets blister with mounting tools included.

Code	Blister Pack	UM	€
3211158	24 Pcs (8 mm)	PCK	
3211161	15 Pcs (11 mm)	PCK	
3211164	10 Pcs (14 mm)	PCK	

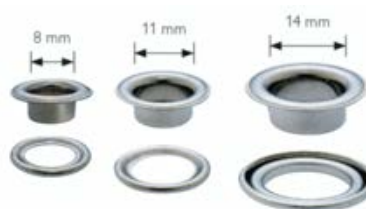
**Canvas Snap Buttons Blister**

Stainless snap buttons in a pack with screws and mounting tools included. Buttons diameter: 15 mm. Screw hole: 4 mm.

Code	Blister Pack	UM	€
3210010	10 Pcs	PCK	



Vario Plus Case Set

Vario case with pliers complete with punches and a complete set of 50 pieces snap buttons and studs for all needs.

Code	UM	€
3210214	PCS	

**Press Tool**

Manual press tool for buttons and studs.

Code	UM	€
3210202	PCS	

**Punches Kit**

Punches kit for buttons and eyelets.

Code	Ref	ø mm	UM	€
3210205	Snap Buttons Kit		PCK	
3210207	Eyelet OC Kit	15	PCK	
3210208	Eyelet OC Kit	19	PCK	
3210209	Eyelet OC Kit	24	PCK	
3210210	Eyelet OC Kit	30	PCK	
3210211	Eyelet OC Kit	22	PCK	

**Chromed Brass Snap Fasteners**

Chromed Brass snap fasteners. Diameter 15 mm. Cap: press on the socket with fabric in the middle. Stud: fix on wood, fiberglass and metals. Post: press to the stud with fabric in the middle to attach fabric to fabric.

Code	Ref	Pack / Pcs	UM	€
3210000	Cap	1000	PCK	
3210001	Socket	1000	PCK	
3210002	Stud	1000	PCK	
3210003	Post	1000	PCK	

**Stainless Steel Press Fasteners**

Stainless Steel press fasteners. Diameter 15 mm. Cap: press on the socket with fabric in the middle. Stud: fix on wood, fiberglass and metals. Post: press to the stud with fabric in the middle to attach fabric to fabric.

Code	Ref	Pack / Pcs	UM	€
3210500	Cap	1000	PCK	
3210501	Socket	1000	PCK	
3210502	Stud	1000	PCK	
3210503	Post	1000	PCK	

**Vario Snap Button Pliers**

Vario pliers for canvas piercing and press fasteners or studs. Punches not included.

Code	UM	€
3210204	PCS	



Turn Clasps with Base

2 Hole turn clasp to be fixed on wood, fiberglass or metal. Screw holes diameter: 4 mm.

Code	Width mm	UM	€
3211000	32	PCS	

**Canvas Turn Clasps**

Canvas turn clasp to be fixed on canvas and covers. Allows a do-it-yourself mounting.

Code	UM	€
3211010	PCS	

**Easy Eyelet and Washer**

Easy eyelet do-it-yourself mounting.

Code	UM	€
3211001	PCS	

**Eyelet and Washer**

Eyelet and washer. Hole diameter: 10 x 15 mm.

Mounting with press tool.

Code	UM	€
3211003	PCS	

**Canvas Turn Clasps Blister**

Stainless turn clasps pack. Screws and mounting tools included.

Code	Blister Pack	UM	€
3211044	4 Pcs	PK	

**Minax Blocking System**

Easy to mount and use automatic Minax button for cover fixing. Snap fixing system head. Screw comes with Minax bayonet head insert.

Code	Ref	UM	€
3214250	Minax Head	PCS	
3214256	Screw	PCS	



Loxx Original Lifting Cap

Genuine german superior quality Loxx spring lifting caps. Brass or Stainless Steel body, Stainless Steel spring.

Code	Ref	Material	UM	€
3214200	Cap	Chrome Nickel Brass	PCS	
3214201	Cap	Chrome Polished Brass	PCS	
3214203	Cap	Stainless Steel	PCS	
3214240	Key		PCS	



LOXX

Loxx Special Lifting Cap

Genuine german superior quality Loxx spring lifting caps. Antique Brass or Gold plated body, Stainless Steel spring. Suitable for old type boats and for elegant interiors.

Code	Ref	Material	UM	€
3214220	Cap	Antique Plated Brass	PCS	
3214221	Cap	Gold Plated Brass	PCS	
3214240	Key		PCS	



LOXX

Loxx Self Tapping Screw

Genuine german superior quality Stainless Steel Loxx self-tapping screws.

Code	Ref	UM	€
3214204	12mm Self-Tapping Screw	PCS	
3214205	16mm Self-Tapping Screw	PCS	
3214215	16mm Self-Tapping Screw (High Head)	PCS	



LOXX

Loxx Screw with Nut

Loxx screw with nut made of Chromed/Nickled Brass.

Code	Ref	UM	€
3214206	M5 10 mm Metric Screw	PCS	
3214216	M5 10 mm Metric Screw (High Head)	PCS	



LOXX

Loxx Base Plate

Loxx base plate made of Nickled/Chromed Brass.

Code	Ref	UM	€
3214207	Base Plate	PCS	
3214217	Base Plate (High Head)	PCS	

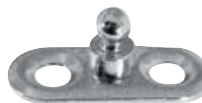

LOXX

Loxx Fabric Base Connector

Loxx fabric base connector made of Nickled/Chromed Brass.

Code	Ref	UM	€
3214210	Fabric Base Connector	PCS	



LOXX

Loxx Windshield Clip

Loxx windshield clips made of Stainless Steel. Clips sizes are suitable to most windshield seals in use.

Code	H mm	UM	€
3214230	21	PCS	
3214231	24	PCS	



LOXX

2 Buttons Loxx Blister

Chromed Nickel Brass automatic Loxx 2 buttons blister.
With screws and mounting tool included.

LOXX

Code	Blister Pack	UM	€
3214282	2 Pcs	PCK	

**8 Buttons Loxx Blister**

Chromed Nickel Brass automatic Loxx 8 buttons blister.
With mounting tool included.

LOXX

Code	Blister Pack	UM	€
3214285	8 Pcs	PCK	

**10 Self Tapping Screws Loxx Blister**

Loxx 10 pieces self tapping Stainless Steel screws blister.
With mounting tool included.

LOXX

Code	Thread H mm	Blister Pack	UM	€
3214290	12	10 Pcs	PCK	
3214291	16	10 Pcs	PCK	

**10 Screws with Nut Loxx Blister**

Loxx 10 pieces M5 10 mm metric screws with nut blister.

LOXX

Code	Blister Pack	UM	€
3214294	10 Pcs	PCK	

**10 Base Plates Loxx Blister**

Loxx 10 pieces base plates blister.
With mounting tool included.

LOXX

Code	Blister Pack	UM	€
3214292	10 Pcs	PCK	

**10 Fabric Base Connectors Loxx Blister**

Loxx 10 pieces fabric bases connectors blister.
With mounting tool included.

LOXX

Code	Blister Pack	UM	€
3214293	10 Pcs	PCK	

**10 Washers Loxx Blister**

Loxx 10 pieces washers blister. These washers can replace standard ones when canvas has more thickness (up to 4 mm).
With mounting tool included.

Code	Blister Pack	UM	€
3214295	10 Pcs	PCK	



LOXX

Loxx Keys

Genuine german Loxx-Tenax button keys.

LOXX

Code	Ref	UM	€
3214240	Standard Small Key	PCS	
3214242	Professional Floating Handle Key	PCS	



Terminal

Stainless Steel terminals for biminis.

Code	For Tubing ø mm	UM	€
3230320	20	PCS	
3230322	22	PCS	
3230325	25	PCS	
3230330	30	PCS	



T Joint

Stainless Steel T joint for biminis.

Code	For Tubing ø mm	UM	€
3230120	20	PCS	
3230122	22	PCS	
3230125	25	PCS	
3230130	30	PCS	



Junction

Stainless Steel junction for biminis.

Code	For Tubing ø mm	UM	€
3220870	22	PCS	
3220871	25	PCS	
3220872	30	PCS	



TA Joint

Stainless Steel open joint for biminis. With security screw.

Code	For Tubing ø mm	UM	€
3230201	22	PCS	
3230202	25	PCS	
3230203	30	PCS	



TAS Joint

Stainless Steel open joint for biminis. With easy off pin and security block.

Code	For Tubing ø mm	UM	€
3230222	22	PCS	
3230225	25	PCS	
3230230	30	PCS	



BP Base

Stainless Steel deck mount base for biminis.

Code	UM	€
3230600	PCS	



BPS Base

Stainless Steel deck mount base for biminis. With easy off pin and security block.

Code	UM	€
3230601	PCS	



BI Base

Stainless Steel declined base for biminis.

Code	UM	€
3230610	PCS	



BIS Base

Stainless Steel declined base for biminis. With easy off pin and security block.

Code	UM	€
3230611	PCS	



BL Base

Stainless Steel side mount base for biminis.

Code	UM	€
3230700	PCS	



BC Base

Stainless Steel rail mount ø 22/25 mm concave base for biminis.

Code	UM	€
3230800	PCS	



BCS Base

Stainless Steel rail mount ø 22/25 mm concave base for biminis. With easy off pin and security block.

Code	UM	€
3230801	PCS	



BPI Base

Stainless Steel pivoting connection base for biminis.

Code	UM	€
3230612	PCS	



BPIS Base

Stainless Steel pivoting connection base for biminis. With easy off pin and security block.

Code	UM	€
3230613	PCS	



Bimini Stretcher

Stainless Steel stretcher plate for bimini wires.

Code	Dim mm	UM	€
3230500	54 x 12	PCS	



Line and Connectors Spare Kit

Connectors spare kit for biminis. Contains: line, 2 fork brackets, 2 bushings, 2 screws with nuts and 4 bimini stretchers.

Code	UM	€
3266070	PCK	



Fork Bracket

Biminis Plastic fork bracket.

Code	UM	€
3221500	PCS	



Fork Bracket Bushing

Biminis Plastic fork bracket bushing.

Code	UM	€
3222000	PCS	



Terminals

Biminis Plastic terminals.

Code	For Tubing ø mm	UM	€
3221020	20	PCS	
3221022	22	PCS	



T Junction Joint

Biminis Plastic T junction joint.

Code	For Tubing ø mm	UM	€
3220520	20	PCS	



T Joint

Biminis Plastic T joint.

Code	For Tubing ø mm	Accessories	UM	€
3220522	22		PCS	
3221022	22	Terminal	PCS	



Sleeve Connector

Biminis Plastic sleeve connector.

Code	For Tubing ø mm	UM	€
3220220	20	PCS	
3220222	22	PCS	



BP Base

Biminis deck mount Plastic flat base.

Code	UM	€
3221712	PCS	



AP Base

Biminis wall mount Plastic base.

Code	Colour	UM	€
3221714	WHITE	PCS	
3221824	BLACK	PCS	



AT Rail Mount Base

Bimini rail mount for tubing ø 22/25 mm.

Code	UM	€
3221722	PCS	



Gummy Base

Inflatables Rubber deck mount base for biminis.

Code	UM	€
3221901	PCS	



2 Arches White Bimini Top

2 Arches sun-water bimini top. Anodized Aluminum frame, 100% Polyester PVC coated fabric. 20mm tubes.

Code	Colour	W cm	L cm	H cm	UM	€
3266053	WHITE	130	180	110	PCS	
3266055	WHITE	150	180	110	PCS	
3266057	WHITE	170	180	110	PCS	

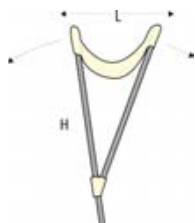

2 Arches Blue Bimini Top

2 Arches sun-water bimini top. Anodized Aluminum frame, 100% Polyester PVC coated fabric. 20mm tubes.

Code	Colour	W cm	L cm	H cm	UM	€
3266063	BLUE	130	180	110	PCS	
3266065	BLUE	150	180	110	PCS	
3266067	BLUE	170	180	110	PCS	

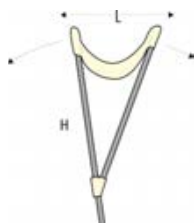

3 Arches White Bimini Top

3 Arches sun-water bimini top. Anodized Aluminum frame, 100% Polyester PVC coated fabric. 20mm tubes.

Code	Colour	W cm	L cm	H cm	UM	€
3265055	WHITE	150	180	110	PCS	
3265057	WHITE	170	180	110	PCS	
3265058	WHITE	185	180	110	PCS	
3265060	WHITE	200	180	110	PCS	

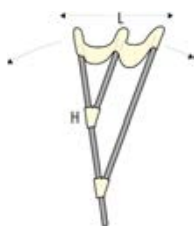

3 Arches Blue Bimini Top

3 Arches sun-water bimini top. Anodized Aluminum frame, 100% Polyester PVC coated fabric. 20mm tubes.

Code	Colour	W cm	L cm	H cm	UM	€
3265065	BLUE	150	180	110	PCS	
3265067	BLUE	170	180	110	PCS	
3265068	BLUE	185	180	110	PCS	
3265070	BLUE	200	180	110	PCS	

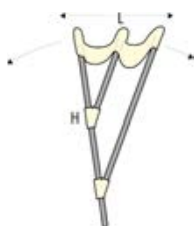

HARDWARE SAILING/COVERS ROPES/FLAGS COVERINGS

3 Arches White High Bimini Top

3 Arches sun-water bimini top. White varnished Aluminum frame, 100% Polyester PVC coated fabric. 20mm tubes.

Code	Colour	W cm	L cm	H cm	UM	€
3265255	WHITE	150	180	140	PCS	
3265257	WHITE	170	180	140	PCS	
3265258	WHITE	185	180	140	PCS	
3265260	WHITE	200	180	140	PCS	
3265262	WHITE	225	140	PCS		

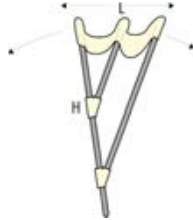

MTM

3 Arches Blue High Bimini Top

3 Arches sun-water bimini top. White varnished Aluminum frame, 100% Polyester PVC coated fabric. 20mm tubes.

Code	Colour	W cm	L cm	H cm	UM	€
3265265	BLUE	150	180	140	PCS	
3265267	BLUE	170	180	140	PCS	
3265268	BLUE	185	180	140	PCS	
3265270	BLUE	200	180	140	PCS	
3265272	BLUE	225	180	140	PCS	

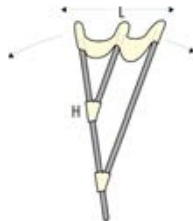

MTM

3 Arches White Stainless Steel High Bimini Top

3 Arches sun-water bimini top. Stainless Steel frame, 100% Polyester PVC coated fabric. 22mm tubes.

Code	Colour	W cm	L cm	H cm	UM	€
3265357	WHITE	185	200	140	PCS	
3265360	WHITE	200	200	140	PCS	
3265362	WHITE	230	235	140	PCS	
3265365	WHITE	245	235	140	PCS	

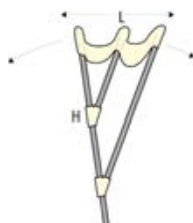

MTM

3 Arches Blue Stainless Steel High Bimini Top

3 Arches sun-water bimini top. Stainless Steel frame, 100% Polyester PVC coated fabric. 22mm tubes.

Code	Colour	W cm	L cm	H cm	UM	€
3265367	BLUE	185	200	140	PCS	
3265370	BLUE	200	180	140	PCS	
3265372	BLUE	230	235	140	PCS	
3265375	BLUE	245	235	140	PCS	

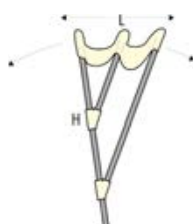

MTM

3 Arches Bimini Top

3 Arches sun-water bimini top. White varnished Aluminum frame, 100% Polyester PVC coated fabric. 20mm tubes.

Code	W cm	L cm	H cm	UM	€
3265015	150	180	110	PCS	
3265017	170	180	110	PCS	
3265020	200	180	110	PCS	
3265022	225	180	110	PCS	

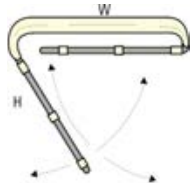

TESSILMARE

3 Arches Bimini Top

3 Arches sun-water bimini top. White varnished Aluminum frame, 100% Polyester PVC coated fabric. 20mm tubes.

Code	W cm	L cm	H cm	UM	€
3265215	150	180	140	PCS	
3265217	170	180	140	PCS	
3265220	200	180	140	PCS	

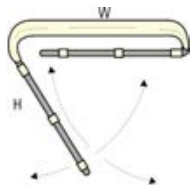

TESSILMARE

4 Arches Fly Bimini Top

4 Arches sun-water bimini top. White varnished Aluminum frame, 100% Polyester PVC coated fabric. 25mm tubes.

Code	W cm	L cm	H cm	UM	€
3268022	225	225	140	PCS	
3268024	240	225	140	PCS	
3268025	255	225	140	PCS	
3268027	270	260	140	PCS	
3268030	295	260	130	PCS	

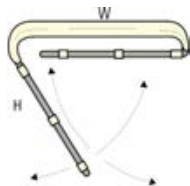

TESSILMARE

2 Arches High Speed Bimini Top

4 Arches Sun-Water Bimini Top. White varnished Aluminum frame, 100% Polyester PVC coated fabric. 25mm tubes.

Code	W cm	L cm	H cm	UM	€
3267017	170	195	95	PCS	
3267020	200	200	110	PCS	
3267022	225	215	115	PCS	

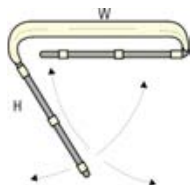

TESSILMARE

3 Arches Biminox White Bimini Top

Disassembling 3 Arches sun-water bimini top. 316 Stainless Steel frame, 100% Polyester PVC coated fabric. 22mm tubes. With the optional pole supports it can be mounted as a Roll-Bar.

Code	Colour	W cm	L cm	H cm	Accessories	UM	€
3265457	White	170	180	140		PCS	
3265460	White	200	180	140		PCS	
3265462	White	230	180	140		PCS	
3265465	White	250	180	140		PCS	
3265400					Support Pole	PR	

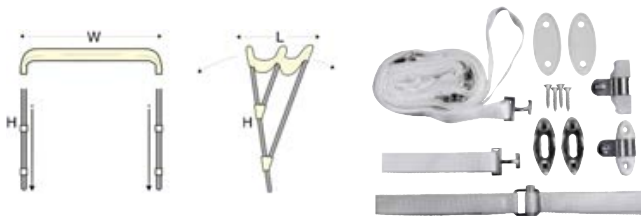

3 Arches Biminox Blue Bimini Top

Disassembling 3 Arches sun-water bimini top. 316 Stainless Steel frame, 100% Polyester PVC coated fabric. 22mm tubes. With the optional pole supports it can be mounted as a Roll-Bar.

Code	Colour	W cm	L cm	H cm	Accessories	UM	€
3265467	Blue	170	180	140		PCS	
3265470	Blue	200	180	140		PCS	
3265472	Blue	230	180	140		PCS	
3265475	Blue	250	180	140		PCS	
3265400					Support Pole	PR	

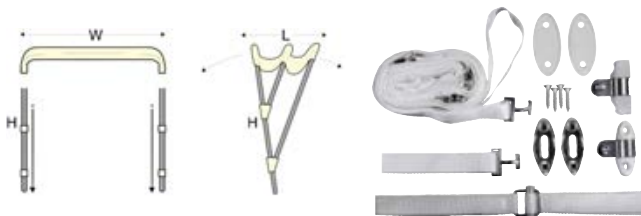

Air Bimini Top

Thin and aerodynamic design sun-water bimini top that creates more shadow than other standard biminis. With innovative fold-up closing system that avoids the bimini to be removed. 316 Stainless Steel frame, 100% Polyester PVC coated fabric. Frame and fabric to be purchased separately. 25mm tubes.

Code	Ref	W cm	L cm	H cm	Fabric	UM	€
3265315	Frame 150	150	210	120		PCS	
3265333					WHITE	PCS	
3265334					BEIGE	PCS	
3265335					BLUE NAVY	PCS	
3265317	Frame 170	170	210	120		PCS	
3265337					WHITE	PCS	
3265338					BEIGE	PCS	
3265339					BLUE NAVY	PCS	
3265318	Frame 185	185	210	120		PCS	
3265340					WHITE	PCS	
3265341					BEIGE	PCS	
3265342					BLUE NAVY	PCS	
3265320	Frame 200	200	210	120		PCS	
3265343					WHITE	PCS	
3265344					BEIGE	PCS	
3265345					BLUE NAVY	PCS	
3265321	Frame 215	215	210	120		PCS	
3265346					WHITE	PCS	
3265347					BEIGE	PCS	
3265348					BLUE NAVY	PCS	
3265323	Frame 230	230	210	120		PCS	
3265349					WHITE	PCS	
3265350					BEIGE	PCS	
3265351					BLUE NAVY	PCS	
3265324	Frame 245	245	210	120		PCS	
3265352					WHITE	PCS	
3265353					BEIGE	PCS	
3265354					BLUE NAVY	PCS	



A (ALFA)

I have a diver down. Keep well clear at slow speed.

Code	cm	UM	€
3405101	20 x 30	PCS	
3405161	40 x 60	PCS	



B (BRAVO)

I am taking in, discharging or carrying dangerous cargo.

Code	cm	UM	€
3405102	20 x 30	PCS	
3405162	40 x 60	PCS	



C (CHARLIE)

Affirmative/Yes.

Code	cm	UM	€
3405103	20 x 30	PCS	
3405163	40 x 60	PCS	



D (DELTA)

I am maneuvering with difficulty; keep clear.

Code	cm	UM	€
3405104	20 x 30	PCS	
3405164	40 x 60	PCS	



E (ECHO)

I am directing my course to starboard.

Code	cm	UM	€
3405105	20 x 30	PCS	
3405165	40 x 60	PCS	



F (FOXTROT)

I am disabled; communicate with me.

Code	cm	UM	€
3405106	20 x 30	PCS	
3405166	40 x 60	PCS	



G (GOLF)

I require a pilot.

Code	cm	UM	€
3405107	20 x 30	PCS	
3405167	40 x 60	PCS	



H (HOTEL)

I have a pilot on board.

Code	cm	UM	€
3405108	20 x 30	PCS	
3405168	40 x 60	PCS	



I (INDIA)

I am directing my course to port.

Code	cm	UM	€
3405109	20 x 30	PCS	
3405169	40 x 60	PCS	

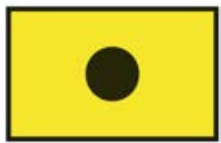

J (JULIET)

I am on fire and have dangerous cargo; keep clear.

Code	cm	UM	€
3405110	20 x 30	PCS	
3405170	40 x 60	PCS	



K (KILO)

I wish to communicate with you.

Code	cm	UM	€
3405111	20 x 30	PCS	
3405171	40 x 60	PCS	



L (LIMA)

You should stop your vessel immediately.

Code	cm	UM	€
3405112	20 x 30	PCS	
3405172	40 x 60	PCS	



M (MIKE)

My vessel is stopped; making no way.

Code	cm	UM	€
3405113	20 x 30	PCS	
3405173	40 x 60	PCS	



N (NOVEMBER)

Negative/No.

Code	cm	UM	€
3405114	20 x 30	PCS	
3405174	40 x 60	PCS	



O (OSCAR)

Man overboard.

Code	cm	UM	€
3405115	20 x 30	PCS	
3405175	40 x 60	PCS	



P (PAPA)

All personnel return to ship; proceeding to sea (Inport).

Code	cm	UM	€
3405116	20 x 30	PCS	
3405176	40 x 60	PCS	



Q (QUEBEC)

Ship meets health regs; request clearance into port.

Code	cm	UM	€
3405117	20 x 30	PCS	
3405177	40 x 60	PCS	



R (ROMEO)

MCM Operations.

Code	cm	UM	€
3405118	20 x 30	PCS	
3405178	40 x 60	PCS	



S (SIERRA)

I am moving astern.

Code	cm	UM	€
3405119	20 x 30	PCS	
3405179	40 x 60	PCS	



T (TANGO)

Do not pass ahead of me. Keep clear, engaged in trawling.

Code	cm	UM	€
3405120	20 x 30	PCS	
3405180	40 x 60	PCS	



U (UNIFORM)

You are running into danger.

Code	cm	UM	€
3405121	20 x 30	PCS	
3405181	40 x 60	PCS	



V (VICTOR)

I require assistance.

Code	cm	UM	€
3405122	20 x 30	PCS	
3405182	40 x 60	PCS	



W (WHISKY)

I require medical assistance.

Code	cm	UM	€
3405123	20 x 30	PCS	
3405183	40 x 60	PCS	



X (X RAY)

Stop carrying out your intentions and watch for my signals.

Code	cm	UM	€
3405124	20 x 30	PCS	
3405184	40 x 60	PCS	



Y (YANKEE)

I am dragging anchor.

Code	cm	UM	€
3405125	20 x 30	PCS	
3405185	40 x 60	PCS	



Z (ZULU)

I require a tug.

Code	cm	UM	€
3405126	20 x 30	PCS	
3405186	40 x 60	PCS	



Answering Pennant

Answering pennant.

Code	cm	UM	€
3405130	20 x 30	PCS	
3405190	40 x 60	PCS	

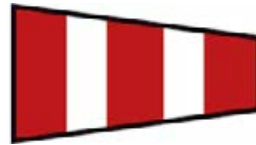

One

Number 1.

Code	cm	UM	€
3405141	20 x 30	PCS	
3405191	40 x 60	PCS	



Two

Number 2.

Code	cm	UM	€
3405142	20 x 30	PCS	
3405192	40 x 60	PCS	



Three

Number 3.

Code	cm	UM	€
3405143	20 x 30	PCS	
3405193	40 x 60	PCS	

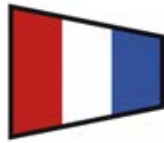

Four

Number 4.

Code	cm	UM	€
3405144	20 x 30	PCS	
3405194	40 x 60	PCS	



Five

Number 5.

Code	cm	UM	€
3405145	20 x 30	PCS	
3405195	40 x 60	PCS	



Six

Number 6.

Code	cm	UM	€
3405146	20 x 30	PCS	
3405196	40 x 60	PCS	



Seven

Number 7.

Code	cm	UM	€
3405147	20 x 30	PCS	
3405197	40 x 60	PCS	



Eight

Number 8.

Code	cm	UM	€
3405148	20 x 30	PCS	
3405198	40 x 60	PCS	



Nine

Number 9.

Code	cm	UM	€
3405149	20 x 30	PCS	
3405199	40 x 60	PCS	



Zero

Number 0.

Code	cm	UM	€
3405150	20 x 30	PCS	
3405188	40 x 60	PCS	



Substitute 1 (FIRST)

Code	cm	UM	€
3405151	20 x 30	PCS	
3405131	40 x 60	PCS	



Substitute 2 (SECOND)

Code	cm	UM	€
3405152	20 x 30	PCS	
3405132	40 x 60	PCS	

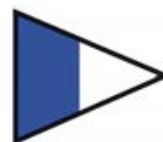

Substitute 3 (THIRD)

Code	cm	UM	€
3405153	20 x 30	PCS	
3405133	40 x 60	PCS	



International Maritime Signal Flags

International Maritime Signal Flags set. Includes 40 flags. Light and cheap made of Nylon, thick and resistant made of Polyester.

Code	cm	Type	Material	UM	€
3405014	14 x 20	Light	NYLON	PCK	
3405020	20 x 30	Light	NYLON	PCK	
3405520	20 x 30	H.D.	POLYESTER	PCK	
3405530	30 x 45	H.D.	POLYESTER	PCK	



Code Flag Set Canvas Bag

Canvas bag for International Maritime Signal Flags.

Code	UM	€
3405202	PCS	



- EXTRA E.U. NAVY FLAGS -

U.S.A. Flag

High quality Polyester fabric flags.

Code	cm	UM	€
3404520	20 x 30	PCS	
3404530	30 x 45	PCS	
3404540	40 x 60	PCS	
3404550	50 x 75	PCS	



Russia Flag

High quality Polyester fabric flags.

Code	cm	UM	€
3404720	20 x 30	PCS	
3404730	30 x 45	PCS	
3404740	40 x 60	PCS	
3404750	50 x 75	PCS	



Serbia Flag

High quality Polyester fabric flags.

Code	cm	UM	€
3404820	20 x 30	PCS	
3404830	30 x 45	PCS	
3404840	40 x 60	PCS	
3404850	50 x 75	PCS	



Ukraine Flag

High quality Polyester fabric flags.

Code	cm	UM	€
3404620	20 x 30	PCS	
3404630	30 x 45	PCS	
3404640	40 x 60	PCS	
3404650	50 x 75	PCS	



Montenegro Flag

High quality Polyester fabric flags.

Code	cm	UM	€
3402820	20 x 30	PCS	
3402830	30 x 45	PCS	



Macedonia Flag

High quality Polyester fabric flags.

Code	cm	UM	€
3402720	20 x 30	PCS	
3402730	30 x 45	PCS	



Bosnia Herzegovina Flag

High quality Polyester fabric flags.

Code	cm	UM	€
3402520	20 x 30	PCS	
3402530	30 x 45	PCS	



Albania Flag

High quality Polyester fabric flags.

Code	cm	UM	€
3401420	20 x 30	PCS	
3401430	30 x 45	PCS	



Turkey Flag

High quality Polyester fabric flags.

Code	cm	UM	€
3404320	20 x 30	PCS	
3404330	30 x 45	PCS	
3404340	40 x 60	PCS	
3404350	50 x 75	PCS	



Egypt Flag

High quality Polyester fabric flags.

Code	cm	UM	€
3404020	20 x 30	PCS	
3404030	30 x 45	PCS	
3404040	40 x 60	PCS	
3404050	50 x 75	PCS	



Tunisia Flag

High quality Polyester fabric flags.

Code	cm	UM	€
3404120	20 x 30	PCS	
3404130	30 x 45	PCS	
3404140	40 x 60	PCS	
3404150	50 x 75	PCS	



St. Vincent and Grenadines Flag

High quality Polyester fabric flags.

Code	cm	UM	€
3403920	20 x 30	PCS	
3403930	30 x 45	PCS	
3403940	40 x 60	PCS	
3403950	50 x 75	PCS	



Italy Flag

High quality Polyester fabric flags.

Code	cm	UM	€
3400020	20 x 30	PCS	
3400030	30 x 45	PCS	
3400040	40 x 60	PCS	
3400050	50 x 75	PCS	
3400070	70 x 100	PCS	
3400080	80 x 120	PCS	



Germany Flag

High quality Polyester fabric flags.

Code	cm	UM	€
3400220	20 x 30	PCS	
3400230	30 x 45	PCS	
3400240	40 x 60	PCS	
3400250	50 x 75	PCS	



France Flag

High quality Polyester fabric flags.

Code	cm	UM	€
3400720	20 x 30	PCS	
3400730	30 x 45	PCS	
3400740	40 x 60	PCS	
3400750	50 x 75	PCS	



Austria Flag

High quality Polyester fabric flags.

Code	cm	UM	€
3400120	20 x 30	PCS	
3400130	30 x 45	PCS	
3400140	40 x 60	PCS	
3400150	50 x 75	PCS	



Croatia Flag

High quality Polyester fabric flags.

Code	cm	UM	€
3400420	20 x 30	PCS	
3400430	30 x 45	PCS	
3400440	40 x 60	PCS	
3400450	50 x 75	PCS	



Slovenia Flag

High quality Polyester fabric flags.

Code	cm	UM	€
3400520	20 x 30	PCS	
3400530	30 x 45	PCS	
3400540	40 x 60	PCS	
3400550	50 x 75	PCS	



Spain Flag

High quality Polyester fabric flags.

Code	cm	UM	€
3400820	20 x 30	PCS	
3400830	30 x 45	PCS	
3400840	40 x 60	PCS	
3400850	50 x 75	PCS	



G.B. Flag

High quality Polyester fabric flags.

Code	cm	UM	€
3400920	20 x 30	PCS	
3400930	30 x 45	PCS	
3400940	40 x 60	PCS	
3400950	50 x 75	PCS	



Greece Flag

High quality Polyester fabric flags.

Code	cm	UM	€
3400320	20 x 30	PCS	
3400330	30 x 45	PCS	
3400340	40 x 60	PCS	
3400350	50 x 75	PCS	



Sweden Flag

High quality Polyester fabric flags.

Code	cm	UM	€
3402220	20 x 30	PCS	
3402230	30 x 45	PCS	
3402240	40 x 60	PCS	
3402250	50 x 75	PCS	



Norway Flag

High quality Polyester fabric flags.

Code	cm	UM	€
3402320	20 x 30	PCS	
3402330	30 x 45	PCS	
3402340	40 x 60	PCS	
3402350	50 x 75	PCS	



Denmark Flag

High quality Polyester fabric flags.

Code	cm	UM	€
3402120	20 x 30	PCS	
3402130	30 x 45	PCS	
3402140	40 x 60	PCS	
3402150	50 x 75	PCS	



Netherlands Flag

High quality Polyester fabric flags.

Code	cm	UM	€
3402020	20 x 30	PCS	
3402030	30 x 45	PCS	
3402040	40 x 60	PCS	
3402050	50 x 75	PCS	



Belgium Flag

High quality Polyester fabric flags.

Code	cm	UM	€
3404920	20 x 30	PCS	
3404930	30 x 45	PCS	
3404940	40 x 60	PCS	
3404950	50 x 75	PCS	



Malta Flag

High quality Polyester fabric flags.

Code	cm	UM	€
3404420	20 x 30	PCS	
3404430	30 x 45	PCS	
3404440	40 x 60	PCS	
3404450	50 x 75	PCS	



Romania Flag

High quality Polyester fabric flags.

Code	cm	UM	€
3402920	20 x 30	PCS	
3402930	30 x 45	PCS	



Bulgaria Flag

High quality Polyester fabric flags.

Code	cm	UM	€
3402620	20 x 30	PCS	
3402630	30 x 45	PCS	



Hungary Flag

High quality Polyester fabric flags.

Code	cm	UM	€
3400620	20 x 30	PCS	
3400630	30 x 45	PCS	
3400640	40 x 60	PCS	
3400650	50 x 75	PCS	



Czech Republic Flag

High quality Polyester fabric flags.

Code	cm	UM	€
3404220	20 x 30	PCS	
3404230	30 x 45	PCS	
3404240	40 x 60	PCS	
3404250	50 x 75	PCS	



Slovakia Flag

High quality Polyester fabric flags.

Code	cm	UM	€
3403720	20 x 30	PCS	
3403730	30 x 45	PCS	



E. U. Flag

High quality Polyester fabric flags.

Code	cm	UM	€
3401520	20 x 30	PCS	
3401530	30 x 45	PCS	
3401540	40 x 60	PCS	
3401550	50 x 75	PCS	



Italy E. U. Flag

High quality Polyester fabric flags.

Code	cm	UM	€
3401020	20 x 30	PCS	
3401030	30 x 45	PCS	



- REGIONAL AND LOCAL FLAGS -

Venezia Pennant

High quality Polyester fabric Venezia pennant with cutted ends.

Code	cm	UM	€
3406220	22 x 44	PCS	
3406230	30 x 60	PCS	



Sicily Flag

High quality Polyester fabric flags.

Code	cm	UM	€
3406320	20 x 30	PCS	
3406330	30 x 45	PCS	
3406340	40 x 60	PCS	



Sardinia Flag

High quality Polyester fabric flags.

Code	cm	UM	€
3406020	20 x 30	PCS	
3406030	30 x 45	PCS	
3406040	40 x 60	PCS	



Corsica Flag

High quality Polyester fabric flags.

Code	cm	UM	€
3406120	20 x 30	PCS	
3406130	30 x 45	PCS	
3406140	40 x 60	PCS	



- WARNING FLAGS -

Red Warning Flag

Red warning flag for beach resorts.

Code	cm	UM	€
3406420	20 x 30	PCS	
3406430	30 x 45	PCS	
3406440	40 x 60	PCS	



Yellow Warning Flag

Yellow warning flag for beach resorts.

Code	cm	UM	€
3406520	20 x 30	PCS	
3406530	30 x 45	PCS	
3406540	40 x 60	PCS	



White Warning Flag

White warning flag for beach resorts.

Code	cm	UM	€
3406620	20 x 30	PCS	
3406630	30 x 45	PCS	
3406640	40 x 60	PCS	

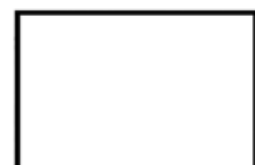

Diver Down Keep Clear (Italy)

Sub flag Italy.

Code	cm	UM	€
3405100	20 x 30	PCS	



- FLAGS AND SIGNALS STICKERS -

Italian Flag Sticker

Italian flag sticker.

Code	Dim mm	UM	€
3418012	120 x 160	PCS	
3418016	160 x 240	PCS	
3418516	160 x 240 Rubber Coated for Inflatables	PCS	



National Flags Sticker

National flags sticker chart.

Code	mm	UM	€
3419205	160 x 240	PCS	



International Codes Sticker

International codes sticker chart. Italian language.

Code	mm	UM	€
3419201	160 x 240 (with Symbols)	PCS	
3419200	120 x 160 (without Symbols)	PCS	



Rescue Signal Codes Sticker

Rescue signal codes sticker chart.

Code	mm	UM	€
3419203	160 x 240	PCS	

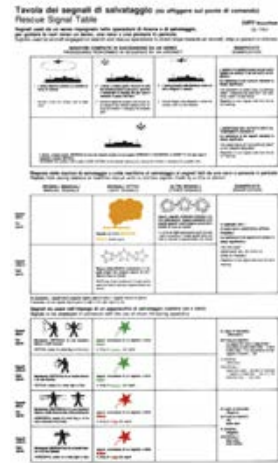

Regatta Signal Flag Chart Sticker

Regatta signal flag sticker chart. Italian language.

Code	mm	UM	€
3419202	155 x 175	PCS	



Navigation Lights & Luminous Signals Sticker

Navigation lights and light signals sticker chart. Italian language.

Code	mm	UM	€
3419204	160 x 240	PCS	

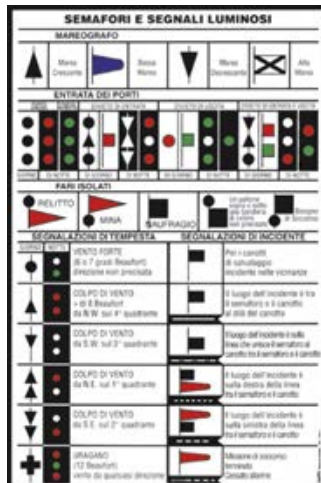

Knots Sticker

Sailor knots sticker. Italian language.

Code	mm	UM	€
3419206	160 x 240	PCS	

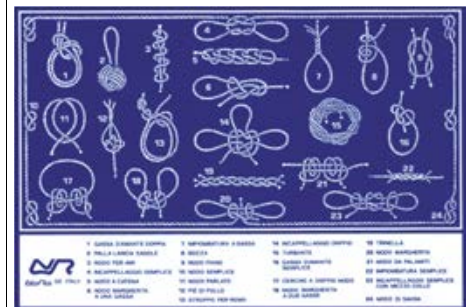

Wind Rose Gold

Wind rose golden self-adhesive sticker. Ø 80 mm.

Code	Label Type	UM	€
3418900	Relief	PCS	
3418910	Classic Thin	PCS	



Wind Rose Ice

Wind rose "Ice" self-adhesive sticker.

Code	Label Type	Ø mm	UM	€
3418901	Relief	80	PCS	
3418911	Classic Thin	80	PCS	
3418917	Classic Thin	150	PCS	



No Shoes Ø 80

No shoes self-adhesive sticker. Ø 80 mm.

Code	Label Type	UM	€
3418902	Relief	PCS	
3418912	Classic Thin	PCS	



No Smoking Ø 80

No smoking self-adhesive sticker. Ø 80 mm.

Code	Label Type	UM	€
3418903	Relief	PCS	
3418913	Classic Thin	PCS	



Don't Throw Objects in W.C.

Don't throw objects in WC self-adhesive sticker. Ø 80 mm.

Code	Label Type	UM	€
3418906	Relief	PCS	
3418916	Classic Thin	PCS	



No Brassiere Ø 80

No brassiere self-adhesive sticker. Ø 80 mm.

Code	Label Type	UM	€
3418904	Relief	PCS	
3418914	Classic Thin	PCS	



No Bikini Ø 80

No bikini self-adhesive sticker. Ø 80 mm.

Code	Label Type	UM	€
3418905	Relief	PCS	
3418915	Classic Thin	PCS	



No Smoking Ø 150

No smoking self-adhesive sticker. Ø 150 mm.

Code	Label Type	UM	€
3419002	Classic Thin	PCS	



No Brassiere Ø 150

No brassiere self-adhesive sticker. Ø 150 mm.

Code	Label Type	UM	€
3419004	Classic Thin	PCS	



3M Safety-Walk General Purpose Antislip Strips

3M Safety-Walk General Purpose self-adhesive non-slip strips suitable for all pedestrian or vehicular surfaces. Constructed with granules bound by synthetic resins on a strong 0.8 mm polyester support.

3M

Code	Colour	Width cm	L m	UM	€
3324622	BLACK	2,5	18,2	PCS	
3324625	BLACK	5,0	18,2	PCS	

**3M Safety-Walk Fine Antislip Strips**

Non-slip self-adhesive comfortable, hygienic and aesthetic strips. Ideal for barefoot walking wet areas. Built in thin 0.6 mm textured rubber.

3M

Code	Colour	Width cm	L m	UM	€
3324602	CLEAR	2,5	18,2	PCS	
3324605	CLEAR	5,0	18,2	PCS	
3324612	WHITE	2,5	18,2	PCS	
3324615	WHITE	5,0	18,2	PCS	

**Blisters Non-Slip Strips 3 Mt**

Blistered top grip and quality non-slip self adhesive tape. Watertight, insulating, comfortable when bare footed, non-slip even if wet. To avoid slips and falls, ideal for boat deck, inflatables, stair noses, pontoon, tiled floor etc.

Composition: Polyurethane Complex Elastomer coated on a Polyester base.

Size: 4 cm x 3 m. Thickness: 1 mm.

Code	Colour	Width cm	L m	UM	€
3320111	WHITE	4	3	PCS	
3320104	SAND	4	3	PCS	
3320105	BLUE	4	3	PCS	
3320110	GREY	4	3	PCS	
3320123	PEARL GREY	4	3	PCS	
3320108	BLACK	4	3	PCS	
3320124	YELLOW	4	3	PCS	



Non-Slip Strips

Top grip and quality non-slip self adhesive tape in 2.1 mm thick reel.

Polyurethane Complex Elastomer coated on a Polyester base.

Watertight, insulating, comfortable when bare footed.

Ideal for boat deck, inflatables, stair noses, gangways.

Sizes: 2.5 cm x 10 m - 4 cm x 10 m. - 10 cm x 10 m.

Code	Colour	Dim	UM	€
3322511	WHITE	2,5 cm x 10 mt	PCS	
3324011	WHITE	4 cm x 10 mt	PCS	
3321011	WHITE	10 cm x 10 mt	PCS	
3322505	BLUE	2,5 cm x 10 mt	PCS	
3324005	BLUE	4 cm x 10 mt	PCS	
3321005	BLUE	10 cm x 10 mt	PCS	
3322510	GREY	2,5 cm x 10 mt	PCS	
3324010	GREY	4 cm x 10 mt	PCS	
3321010	GREY	10 cm x 10 mt	PCS	
3322508	BLACK	2,5 cm x 10 mt	PCS	
3324008	BLACK	4 cm x 10 mt	PCS	
3321008	BLACK	10 cm x 10 mt	PCS	
3322506	IVORY	2,5 cm x 10 mt	PCS	
3324006	IVORY	4 cm x 10 mt	PCS	
3321006	IVORY	10 cm x 10 mt	PCS	
3322504	SAND	2,5 cm x 10 mt	PCS	
3324004	SAND	4 cm x 10 mt	PCS	
3321004	SAND	10 cm x 10 mt	PCS	
3322503	MAHOGANY	2,5 cm x 10 mt	PCS	
3324003	MAHOGANY	4 cm x 10 mt	PCS	
3321003	MAHOGANY	10 cm x 10 mt	PCS	

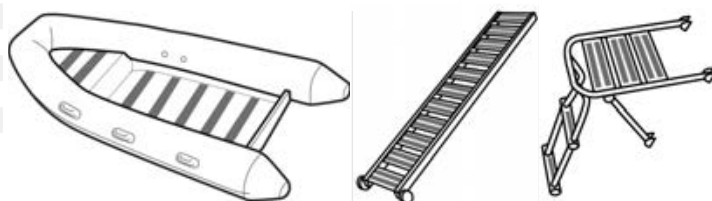
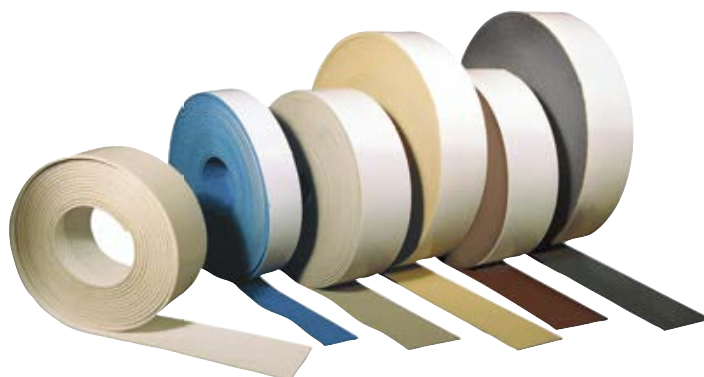
**Rolls Antislip TBS21**

Antislip professional floor covering in 60 cm x 10 m and 128 cm x 5 m reels.

Polyurethane Complex Elastomer coated on a Polyester base.

Thickness: 2.1 mm. Watertight, insulating, comfortable when barefooted.

For safe moving on work and pleasure boats.

Ideal for boat deck, gangways and tiled floors.

Code	Colour	Width cm	L m	UM	€
3325011	IVORY	60	10	PCK	
3326011	IVORY	128	5	PCK	
3325010	GREY	60	10	PCK	
3326010	GREY	128	5	PCK	
3325001	SLATE GREY	60	10	PCK	
3326001	SLATE GREY	128	5	PCK	
3325004	SAND	60	10	PCK	
3326004	SAND	128	5	PCK	
3325003	MAHOGANY	60	10	PCK	
3326003	MAHOGANY	128	5	PCK	
3325002	WHITE	60	10	PCK	
3326002	WHITE	128	5	PCK	
3325009	BLACK	60	10	PCK	
3326009	BLACK	128	5	PCK	
3325007	PEARL GREY	60	10	PCK	
3326007	PEARL GREY	128	5	PCK	

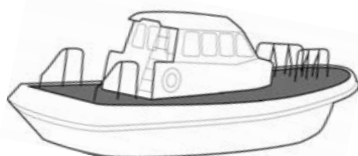
**Plain Sheets Antislip TBS21**

Antislip professional floor covering in 128 x 90 cm plain sheets.

Polyurethane Complex Elastomer coated on a Polyester base.

Sheet thickness: 2.1 mm. Watertight, insulating, comfortable when barefooted.

For safe moving on work and pleasure boats.

Ideal for boat deck, gangways and tiled floors.

Code	Colour	UM	€
3325511	WHITE	PCS	
3325506	IVORY	PCS	
3325505	BLUE	PCS	
3325510	GREY	PCS	
3325508	BLACK	PCS	
3325501	SLATE GREY	PCS	
3325504	SAND	PCS	
3325503	MAHOGANY	PCS	



Fonox-B Noise Absorber Coating

Fonox light and cheap weavy noise absorber coating. Easy to apply, isolates from the noise (10dB).

Code	> < mm	dB	cm	UM	€
3317040	30	10	100 x 200	PCS	

**Vetral Noise/Thermo Absorber Coating**

Vetral noise/thermo absorber coating with Lead insert. Isolates from noise (20dB) and heat. Aluminized fibreglass coating resistant to high temperatures. R.I.Na. CDS/467-95/TAO certified. Self extinguishing according to UL94HF1 rules.

Code	> < mm	dB	cm	UM	€
3317520	14	22	100 x 300	PCS	

**SOUNDFIL Noise/Thermo Absorber Coating**

Soundfil 3317022 and 3317024 (with heavy Rubber insert) noise/thermo insulating coatings. Polymeric mass and Polyester fibres coated protected with rot-proof Fibreglass fabric. 150 x 90 cm self-adhesive sheets. Suggested application with dedicated glue according to the panel type. Class 1 fire resistance UNI8457+UNI9174.

Code	> < mm	dB	cm	Heavy Rubber Insert	UM	€
3317022	20	20	90 x 150	NO	PCS	
3317024	20	30	90 x 150	YES	PCS	

**IMATT 20 TS Heat Absorber Coating**

Non-flammable Aluminized Fibreglass coated Fibreglass canvas thermo absorber coating. Perfect for exhaust pipes and engine rooms. R.I.Na. CCE33701 - CDS/467-95/TAO certified. Temperature resistant up to 675°. 2 pcs per package.

Code	> < mm	cm	UM	€
3320072	20	100 x 150	PCK	

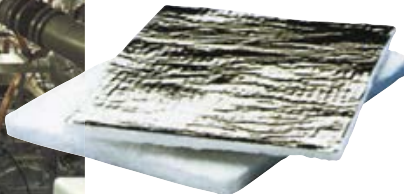
**Adhesive Fonox-FK Noise/Thermo Absorber Coating**

Self-adhesive Fonox-FK noise/thermo absorber coating. Isolates from noise (10 dB) and heat. Aluminized Fibreglass coating resistant to high temperatures. R.I.Na. CDS/467-95/TAO certified. Self-extinguishing according to UL94HF1 rules.

Code	> < mm	dB	cm	UM	€
3317020	16	10	100 x 150	PCS	

**Agloabsorber Noise/Thermo Absorber Coating**

Agloabsorber professional noise/thermo absorber coating. Lightweight and efficient, ideal for engine rooms. Noise isolation 25dB for panels up to 2mm. Self extinguishing, fire resistance according to DIN 4102-FMVSS302-UL94 HBF-M4 rules. Aluminized Fibreglass coated with up to 180°C temperature resistance.

Code	> < mm	dB	cm	UM	€
3317525	20	25	100 x 200	PCS	

**Akustikabsorber Noise/Thermo Absorber Coating**

Noise/thermo absorber coating with heavy Rubber insert, the real and specific absorber for engine rooms of any type of boat. Noise isolation 30dB on panels up to 2 mm. To be applied with dedicated glue according to the panel type. Fire resistance according to DIN4102-FMVSS302-UL94-HBF-M4.

Code	> < mm	dB	cm	UM	€
3317530	30	30	100 x 120	PCS	

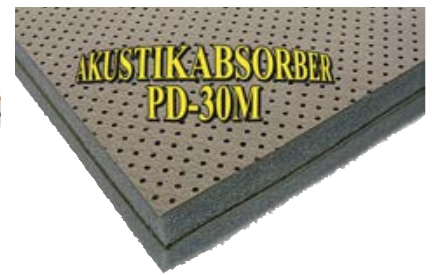
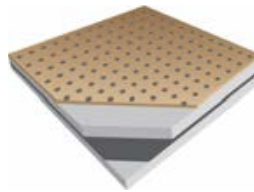
**IMATT 10 TR Heat Absorber Coating**

High thermo capacity quilted Aluminized Fibreglass coated Fibreglass canvas thermo absorber coating. Non-flammable. Perfect for engine rooms. Continuous temperature working range: -30° +550°.

Code	> < mm	cm	UM	€
3320074	10	100 x 150	PCS	



Exhaust Thermo Cover

Glass canvas and Ceramic fiber thermo insulating exhaust covers. It can withstand up to 800° temperature. Stainless Steel mounting spring included.

R.I.Na. CCE33701-CDS/467-95/TAO certified.

Code	Dimensions cm	For Exhaust ø mm	UM	€
3320084	100 x 38	70	PCS	
3320085	100 x 43	85	PCS	
3320086	100 x 48	100	PCS	
3320087	100 x 54	124	PCS	
3320088	100 x 60	150	PCS	
3320089	100 x 68	168	PCS	
3320090	100 x 83	220	PCS	

**SMB Turbine Thermo Cover**

Glass canvass and Ceramic fiber turbo covers.

It can withstand up to 800° temperature.

Stainless Steel mounting spring included.

Code	Ref	Turbine ø mm	Width mm	UM	€
3320081	Small	180-200	70-80	PCS	
3320082	Medium	230-250	80-90	PCS	
3320083	Large	290-310	80-90	PCS	

**High Temperature Elastic Insulating Tape**

Elastic thermo insulating Fiberglass-Metal tape resistant to high temperatures. Made of Fibreglass fabric combined with Aluminum layer which makes it more flexible. Its elastic capacities can be easily applied also to the exhaust elbows. It usually takes 2/3 layers to be sufficient for most diesel exhaust systems. Maximum operating temperature: 600°C. A protective outer layer of self-amalgamating elastomer tape resistant to high temperatures can be added to create a homogeneous surface.

Code	Width mm	Length mm	Thickness mm	Accessories	UM	€
3320076	50	5,5	5		PCS	
3320077	100	5,5	5		PCS	
3320078	75	5	1,15	Elastomer Tape	PCS	

**High Temp Seam Tape**

High temperature Aluminum self-adhesive tape. For fix, finish and contain insulating coatings of exhaust tubes and engine rooms.

Code	H mm	L m	UM	€
3320075	50	45	PCS	

**High Temp Ceramic Fiber Tape**

Thick foam heat reduction Ceramic yarn tape for exhaust and engine rooms. Can withstand temperature up to 750°. Thickness: 3 mm.

Code	H mm	L m	UM	€
3320055	50	25	PCS	
3320060	100	25	PCS	

**Sheetstopper**

Aluminum washers and plates to fix insulating panels.

3320079 washers fix the panels with tapping or machine screws.

3320080 Harpoon plates can be fixed with screws, fiberglass or epoxy glue. Panels are pierced by harpoon on which applies the 3320079 washer, then the harpoon is bented to fix the washer and the panel.

Code	Ref	Dimensions mm	UM	€
3320079	Washer	ø 35	PCS	
3320080	Harpoon Plate	50 x 50 x H70	PCS	

