

2

HARDWARE /
LOCKS /
FASTENERS



M T M

D Shackle

316 Stainless Steel Dee shackle.

Code	D mm	L mm	W mm	UM	€
0120004	4	16	8	PCS	
0120005	5	20	10	PCS	
0120006	6	24	12	PCS	
0120008	8	32	16	PCS	
0120010	10	40	20	PCS	
0120012	12	48	24	PCS	
0120014	14	56	28	PCS	
0120016	16	64	32	PCS	

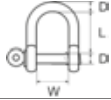
**Captive Pin D Shackle**

316 Stainless Steel captive pin Dee shackle.

Code	D mm	L mm	W mm	UM	€
0120104	4	16	8	PCS	
0120105	5	20	10	PCS	
0120106	6	24	12	PCS	
0120108	8	32	16	PCS	
0120110	10	40	20	PCS	

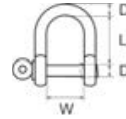
**Bow Shackle**

316 Stainless Steel Bow shackle.

Code	D mm	L mm	W mm	UM	€
0120505	5	16	9	PCS	
0120506	6	21	12	PCS	
0120508	8	27	16	PCS	
0120510	10	33	20	PCS	
0120512	12	40	23	PCS	
0120514	14	51	27	PCS	
0120516	16	60	32	PCS	

**Captive Pin Bow Shackle**

316 Stainless Steel captive pin Bow shackle.

Code	D mm	L mm	W mm	UM	€
0120545	5	25	10	PCS	
0120546	6	30	12	PCS	
0120548	8	40	16	PCS	
0120550	10	50	20	PCS	

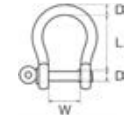
**Long D Shackle**

316 Stainless Steel Long Dee shackle.

Code	D mm	L mm	W mm	UM	€
0120804	4	32	8	PCS	
0120805	5	40	10	PCS	
0120806	6	48	12	PCS	
0120808	8	64	16	PCS	
0120810	10	80	20	PCS	

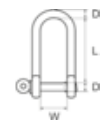
**Captive Pin Long D Shackle**

316 Stainless Steel captive pin Long Dee shackle.

Code	D mm	L mm	W mm	UM	€
0120704	4	32	8	PCS	
0120705	5	40	10	PCS	
0120706	6	48	12	PCS	
0120708	8	64	16	PCS	

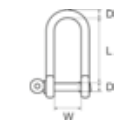
**Wide D Shackle**

316 Stainless Steel Wide Dee shackle.

Code	D mm	L mm	W mm	UM	€
0121106	6	36	24	PCS	
0121108	8	36	28	PCS	
0121110	10	60	40	PCS	
0121112	12	72	48	PCS	

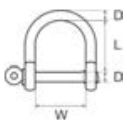
**Twisted D Shackle**

316 Stainless Steel Twisted Dee shackle.

Code	D mm	L mm	W mm	UM	€
0121005	5	30	10	PCS	
0121006	6	36	12	PCS	
0121008	8	40	16	PCS	
0121010	10	50	20	PCS	

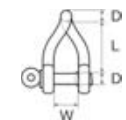
**Key Pin Long D Shackle**

316 Stainless Steel captive key pin Long Dee shackle.

Code	D mm	L mm	W mm	UM	€
0120905	5	40	13	PCS	
0120906	6	45	16	PCS	
0120908	8	64	22	PCS	

**Key Pin Long D Shackle B**

316 Stainless Steel captive key pin Long Dee Shackle with bar.

Code	D mm	L mm	W mm	UM	€
0120915	5	40	13	PCS	
0120916	6	45	16	PCS	
0120918	8	64	22	PCS	



Wichard D Shackle

Wichard 316 Stainless Steel self-locking Dee Shackle. Breaking load (BL) tested and guaranteed.

Code	D mm	L mm	W mm	BL Kg	UM	€
3521004	4	13	8	700	PCS	
3521005	5	16	10	1000	PCS	
3521006	6	20	12	1600	PCS	
3521008	8	26	16	2700	PCS	
3521010	10	33	20	4300	PCS	
3521012	12	39	24	6000	PCS	

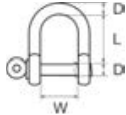
**Wichard Captive Pin D Shackle**

Wichard standard 316 Stainless Steel self-locking captive pin Dee Shackle. Breaking load (BL) tested and guaranteed.

Code	D mm	L mm	W mm	BL Kg	UM	€
3521024	4	13	8	1000	PCS	
3521025	5	16	10	1500	PCS	
3521026	6	20	12	2200	PCS	
3521028	8	26	16	3600	PCS	
3521030	10	33	20	5200	PCS	

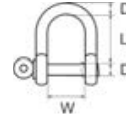
**Wichard Bow Shackle**

Wichard 316 Stainless Steel self-locking Bow Shackle. Breaking load (BL) tested and guaranteed.

Code	D mm	L mm	W mm	BL Kg	UM	€
3521204	4	18	8	700	PCS	
3521205	5	23	10	1000	PCS	
3521206	6	28	12	1600	PCS	
3521208	8	37	16	2700	PCS	
3521210	10	47	20	4300	PCS	
3521212	12	55	24	6000	PCS	

**Wichard Captive Pin Bow Shackle**

Wichard 316 Stainless Steel self-locking captive pin Bow Shackle. Breaking load (BL) tested and guaranteed.

Code	D mm	L mm	W mm	BL Kg	UM	€
3521224	4	18	8	1000	PCS	
3521225	5	23	10	1500	PCS	
3521226	6	28	12	2200	PCS	
3521228	8	37	16	3700	PCS	
3521230	10	47	20	5200	PCS	

**Wichard Long D Shackle**

Wichard 316 Stainless Steel self-locking Long Dee Shackle. Breaking load (BL) tested and guaranteed.

Code	D mm	L mm	W mm	BL Kg	UM	€
3521104	4	22	8	700	PCS	
3521105	5	29	10	1000	PCS	
3521106	6	33	12	1600	PCS	
3521108	8	45	16	2700	PCS	
3521110	10	55	20	4300	PCS	

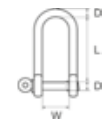
**Wichard Captive Pin Long D Shackle**

Wichard 316 Stainless Steel self-locking captive pin Long Dee Shackle. Breaking load (BL) tested and guaranteed.

Code	D mm	L mm	W mm	BL Kg	UM	€
3521124	4	31	8	1000	PCS	
3521125	5	39	10	1500	PCS	
3521126	6	46	12	2200	PCS	
3521128	8	62	16	3600	PCS	

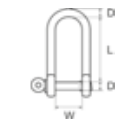
**Wichard Twisted D Shackle**

Wichard 316 Stainless Steel self-locking Twisted Shackle. Breaking load (BL) tested and guaranteed.

Code	D mm	L mm	W mm	BL Kg	UM	€
3521305	5	26	10	1100	PCS	
3521306	6	30	12	1500	PCS	
3521308	8	40	16	3000	PCS	

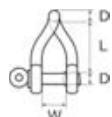
**Wichard Captive Pin Twisted D Shackle**

Wichard 316 Stainless Steel self-locking captive pin Twisted Shackle. Breaking load (BL) tested and guaranteed.

Code	D mm	L mm	W mm	BL Kg	UM	€
3521325	5	38	10	1500	PCS	
3521326	6	44	12	2100	PCS	
3521328	8	59	16	3700	PCS	

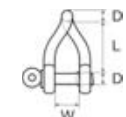

MTM D Shackle

High quality 316 Stainless Steel Dee Shackle supplied on presentation card. Working Load (WL) tested and guaranteed. Breaking Load (BL) is 4 times Working Load.

Code	D mm	L mm	W mm	WL Kg	BL Kg	UM	€
0120005C	5	20	10	230	920	PCS	
0120006C	6	24	12	330	1320	PCS	
0120008C	8	32	16	600	2400	PCS	
0120010C	10	40	20	930	3720	PCS	
0120012C	12	48	24	1400	5600	PCS	
0120014C	14	56	28	1800	7200	PCS	

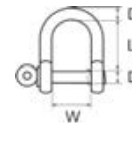

MTM

MTM Bow Shackle

High quality 316 Stainless Steel Bow Shackle supplied on presentation card. Working Load (WL) tested and guaranteed. Breaking Load (BL) is 4 times Working Load.

Code	D mm	L mm	W mm	WL Kg	BL Kg	UM	€
0120506C	6	21	12	330	1320	PCS	
0120508C	8	27	16	590	2370	PCS	
0120510C	10	33	20	930	3720	PCS	
0120512C	12	40	23	1370	5490	PCS	
0120514C	14	51	27	1800	7200	PCS	
0120516C	16	60	32	2440	9760	PCS	

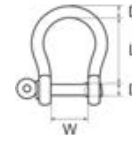

MTM

MTM Long D Shackle

High quality 316 Stainless Steel Long Dee Shackle supplied on presentation card. Working Load (WL) tested and guaranteed. Breaking Load (BL) is 4 times Working Load.

Code	D mm	L mm	W mm	WL Kg	BL Kg	UM	€
0120805C	5	40	10	230	920	PCS	
0120806C	6	48	12	330	1320	PCS	
0120808C	8	64	16	600	2400	PCS	
0120810C	10	80	20	930	3720	PCS	

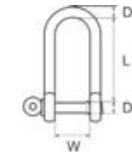

MTM

MTM Twisted D Shackle

High quality 316 Stainless Steel Twisted Dee Shackle supplied on presentation card. Working Load (WL) tested and guaranteed. Breaking Load (BL) is 4 times Working Load.

Code	D mm	L mm	W mm	WL Kg	BL Kg	UM	€
0121005C	5	30	10	230	920	PCS	
0121006C	6	36	12	330	1320	PCS	
0121008C	8	40	16	600	2400	PCS	
0121010C	10	50	20	930	3720	PCS	

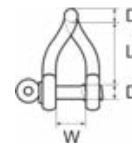

MTM

MTM Extra Wide D Shackle

High quality 316 Stainless Steel Wide Dee Shackle supplied on presentation card. Working Load (WL) tested and guaranteed. Breaking Load (BL) is 4 times Working Load.

Code	D mm	L mm	W mm	WL Kg	BL Kg	UM	€
0121106C	6	36	24	330	1320	PCS	
0121108C	8	36	28	600	2400	PCS	
0121110C	10	60	40	930	3720	PCS	
0121112C	12	72	48	1400	5600	PCS	

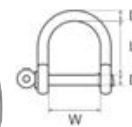

MTM

MTM Key Pin Long D Shackle

High quality captive key pin 316 Stainless Steel Long Dee Shackle supplied on presentation card. Working Load (WL) tested and guaranteed. Breaking Load (BL) is 4 times Working Load.

Code	D mm	L mm	W mm	WL Kg	BL Kg	UM	€
0120905C	5	40	13	230	920	PCS	
0120906C	6	45	16	330	1320	PCS	
0120908C	8	64	22	600	2400	PCS	

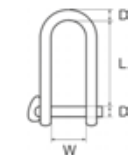

MTM

MTM Key Pin Long D Shackle B

High quality captive key pin 316 Stainless Steel Long Dee Shackle with bar supplied on presentation card. Working Load (WL) tested and guaranteed. Breaking Load (BL) is 4 times Working Load.

Code	D mm	L mm	W mm	WL Kg	BL Kg	UM	€
0120915C	5	40	13	230	920	PCS	
0120916C	6	45	16	330	1320	PCS	
0120918C	8	64	22	600	2400	PCS	

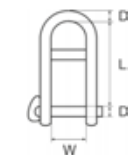

MTM

D Shackle

316 Stainless Steel stamped Dee Shackle.

Code	D mm	L mm	W mm	UM	€
0121515	4	15	10	PCS	
0121517	5	17	12	PCS	
0121524	4	20	10	PCS	
0121525	5	24	16	PCS	
0121542	6	23	16	PCS	

**D Shackle**

316 Stainless Steel stamped Dee Shackle.

Code	D mm	L mm	W mm	UM	€
0121540	5	36	16	PCS	
0121543	6	40	14	PCS	
0121544	8	42	18	PCS	

**Stamped D Ring Shackle**

316 Stainless Steel stamped Dee Shackle with ring.

Code	D mm	L mm	W mm	UM	€
0121502	4	15	10	PCS	
0121503	4	24	12	PCS	
0121504	5	17	12	PCS	
0121505	5	25	16	PCS	
0121506	5	37	22	PCS	

**Stamped Twisted Shackle**

316 Stainless Steel stamped twisted Shackle.

Code	D mm	L mm	W mm	UM	€
0121552	5	22	12	PCS	
0121557	6	36	14	PCS	

**Stamped HS Narrow D Shackle**

316 Stainless Steel stamped narrow HS Dee shackle. Tested working load (WL). The breaking load (BL) is 4 times the working load.

Code	D mm	L mm	W mm	WL Kg	UM	€
0121614	4	16	8	150	PCS	
0121615	5	20	8	250	PCS	
0121616	5	22	12	275	PCS	
0121617	6	25	13	325	PCS	

**Stamped HS Wide D Shackle**

316 Stainless Steel stamped wide HS Dee shackle. Tested working load (WL). The breaking load (BL) is 4 times the working load.

Code	D mm	L mm	W mm	WL Kg	UM	€
0121624	4	20	10	150	PCS	
0121625	5	20	11	250	PCS	
0121626	5	22	15	275	PCS	
0121627	6	25	17	325	PCS	

**Stamped HS D Screw Shackle**

316 Stainless Steel stamped HS Dee shackle with screw. Tested working load (WL). The breaking load (BL) is 4 times the working load.

Code	D mm	L mm	W mm	WL Kg	UM	€
0121664	4	16	10	125	PCS	
0121665	5	20	10	250	PCS	
0121666	6	25	15	325	PCS	

**Stamped HS D Ring Shackle**

316 Stainless Steel stamped HS Dee shackle with ring. Tested working load (WL). The breaking load (BL) is 4 times the working load.

Code	D mm	L mm	W mm	WL Kg	UM	€
0121507	5	17	8	187	PCS	
0121508	5	21	9	187	PCS	
0121509	5	36	14	250	PCS	
0121510	5	36	18	250	PCS	

**Key Pin Stamped D Shackle**

316 Stainless Steel key pin stamped Dee Shackle.

Code	D mm	L mm	W mm	UM	€
0121562	4	22	11	PCS	
0121563	5	36	15	PCS	
0121564	6	40	15	PCS	

**Key Pin Stamped D Shackle with Bar**

316 Stainless Steel key pin stamped Dee Shackle with bar.

Code	D mm	L mm	L1 mm	W mm	UM	€
0121573	5	21	12	15	PCS	
0121574	6	25	12	15	PCS	
0121575	8	26	12	20	PCS	



Standard Carabiner

316 Stainless Steel Standard Carabiner.

Code	D mm	L mm	A mm	UM	€
0211150	5	50	8	PCS	
0211160	6	60	9	PCS	
0211170	7	70	9	PCS	
0211180	8	80	10	PCS	
0211110	10	100	12	PCS	
0211112	11	120	16	PCS	
0211114	12	140	20	PCS	
0211116	13	160	26	PCS	

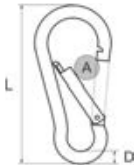

Standard Carabiner Eye

316 Stainless Steel Standard Carabiner with eye.

Code	D mm	L mm	A mm	O mm	UM	€
0211350	5	50	8	7.5	PCS	
0211360	6	60	9	9	PCS	
0211370	7	70	9	10	PCS	
0211380	8	80	10	11.5	PCS	
0211310	10	100	12	14	PCS	
0211312	11	120	16	16.5	PCS	
0211314	12	140	20	18	PCS	
0211316	13	160	26	20	PCS	

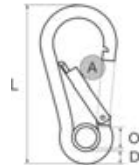

Side Carabiner

316 Stainless Steel Carabiner with wide side opening. It prevents ropes from tangling.

Code	D mm	L mm	A mm	UM	€
0211791	8	80	22	PCS	
0211792	10	100	24	PCS	
0211793	11	120	26	PCS	



Wide Carabiner

316 Stainless Steel Carabiner with wide opening.

Code	D mm	L mm	A mm	UM	€
0211891	8	85	18	PCS	
0211892	10	100	19	PCS	
0211893	11	125	26	PCS	



Wide Lock Carabiner

316 Stainless Steel Carabiner with wide opening and screw lock.

Code	D mm	L mm	A mm	UM	€
0211860	6	60	10	PCS	
0211880	8	80	14	PCS	
0211810	10	100	20	PCS	
0211812	11	120	24	PCS	



Wide Lock Carabiner Eye

316 Stainless Steel Carabiner with wide opening, screw lock and eye.

Code	D mm	L mm	A mm	O mm	UM	€
0212060	6	60	10	9	PCS	
0212080	8	80	14	11	PCS	
0212010	10	100	20	14	PCS	
0212012	11	120	24	18	PCS	

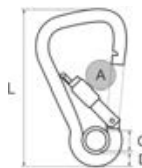

MTM Standard Carabiner

High quality 316 Stainless Steel Standard Carabiner supplied on presentation card. Working Load (WL) tested and guaranteed. Breaking Load (BL) is 4 times Working Load.

Code	D mm	L mm	A mm	WL Kg	UM	€
0211150C	5	50	8	90	PCS	
0211160C	6	60	9	130	PCS	
0211180C	8	80	10	180	PCS	
0211110C	10	100	12	280	PCS	



MTM Standard Carabiner Eye

High quality 316 Stainless Steel Standard Carabiner with eye supplied on presentation card. Working Load (WL) tested and guaranteed. Breaking Load (BL) is 4 times Working Load.

Code	D mm	L mm	A mm	O mm	WL Kg	UM	€
0211350C	5	50	8	7.5	90	PCS	
0211360C	6	60	9	9	130	PCS	
0211380C	8	80	10	11.5	180	PCS	
0211310C	10	100	12	14	280	PCS	



Kong Standard Carabiner

316 Stainless Steel Carabiner with antigrip hooking system. Avoids tangling of lines.

Code	D mm	L mm	A mm	UM	€
0211605	5	50	7	PCS	
0211606	6	60	8	PCS	
0211607	7	72	10	PCS	
0211608	8	80	10	PCS	
0211610	10	103	15,5	PCS	
0211612	10,5	121	17	PCS	
0211613	13	160	30	PCS	

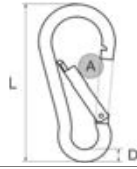

Kong Standard Carabiner Eye

316 Stainless Steel Carabiner with eye and antigrip hooking system. Avoids tangling of lines.

Code	D mm	L mm	A mm	O mm	UM	€
0211615	5	50	7	6	PCS	
0211616	6	60	8	7	PCS	
0211617	7	72	10	9	PCS	
0211618	8	80	10	10	PCS	
0211620	10	103	15,5	12	PCS	
0211622	10,5	121	17	15	PCS	
0211623	13	160	30	22	PCS	

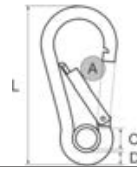

Kong Side Carabiner

316 Stainless Steel Carabiner with wide side opening. Antigrip hooking system. Avoids tangling of lines.

Code	D mm	L mm	A mm	UM	€
0211781	8	80	22	PCS	
0211711	10	100	24	PCS	
0211712	11	120	26	PCS	



Kong Side Carabiner Eye

316 Stainless Steel Carabiner with wide side opening and eye. Antigrip hooking system. Avoids tangling of lines.

Code	D mm	L mm	A mm	O mm	UM	€
0211981	8	80	24	11	PCS	
0211911	10	100	24	14	PCS	
0211912	11	120	26	18	PCS	



Kong Wide Carabiner

Stainless Steel 316 Carabiner with wide opening. Antigrip hooking system. Avoids tangling of lines.

Code	D mm	L mm	A mm	UM	€
0212150	5	52	9	PCS	
0212160	6	65	12	PCS	
0212180	8	85	18	PCS	
0212110	10	100	19	PCS	
0212112	11	125	26	PCS	

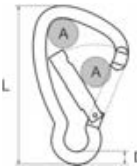

Kong Wide Carabiner Eye

316 Stainless Steel Carabiner with wide opening and eye. Antigrip hooking system. Avoids tangling of lines.

Code	D mm	L mm	A mm	O mm	UM	€
0212350	5	52	9	8	PCS	
0212360	6	65	12	9	PCS	
0212380	8	85	18	11	PCS	
0212310	10	100	19	14	PCS	
0212312	11	125	26	18	PCS	

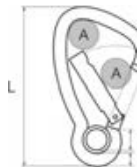

Kong Out Lock Carabiner

316 Stainless Steel Carabiner with outward opening and sliding lock. Antigrip hooking system. Avoids tangling of lines.

Code	D mm	L mm	A mm	UM	€
0211780	8	80	20	PCS	
0211710	10	100	24	PCS	



Kong Out Lock Carabiner Eye

316 Stainless Steel Carabiner with outward opening, sliding lock and eye. Antigrip hooking system. Avoids tangling of lines.

Code	D mm	L mm	A mm	O mm	UM	€
0211980	8	80	20	11,5	PCS	
0211910	10	100	24	14	PCS	

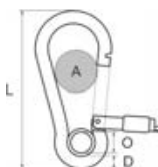

Swivel Eye Standard Snap

316 Stainless Steel swiveling eye snap.

Code	L mm	O mm	UM	€
0211565	68	13	PCS	
0211585	85	18	PCS	

**Swivel Standard Eye Bolt Snap**

316 Stainless Steel bolt snap hook with swivel eye. Piston pin opening.

Code	L mm	O mm	UM	€
0211506	64	10	PCS	
0211508	80	13	PCS	

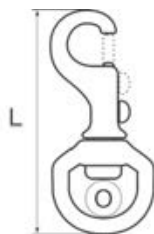
**Swivel Square Eye Bolt Snap**

316 Stainless Steel bolt snap hook with swivel belt loop.

Code	L mm	O mm	UM	€
0211516	61	13	PCS	
0211518	81	21	PCS	

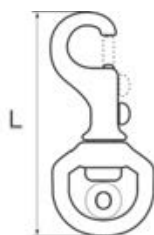
**Fixed Eye Snap**

316 Stainless Steel fixed eye snap.

Code	L mm	O mm	UM	€
0211453	53	10	PCS	
0211473	73	16	PCS	

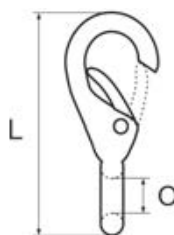
**Belt Snap**

316 Stainless Steel snap with belt loop.

Code	A mm	C mm	UM	€
0211450	48	25	PCS	

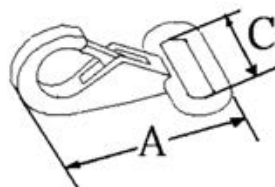
**Security Spring Hook Snap**

Security spring hook snap with belt/line eyelet for sailboats safety harnesses and bosun's wraps. Rugged 316 Stainless Steel construction.

Code	D mm	L mm	A mm	O mm	UM	€
0212580	8	80	14	16	PCS	
0212510	10	100	20	20	PCS	

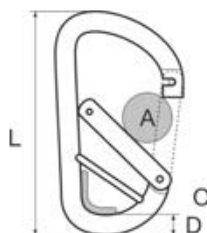
**Flat Security Spring Hook Snap**

Security spring hook snap with belt/line eyelet for sailboats safety harnesses and bosun's wraps. With lock lever and composite protection. Rugged 316 Stainless Steel construction.

Code	L mm	A mm	O mm	UM	€
0212611	100	16	24	PCS	

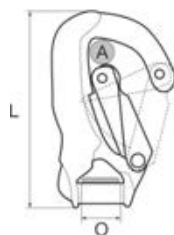

Open End Snap Hook

316 Stainless Steel open end spring gate jib snap hook. Used for attaching the jib onto the bow eye bolt, it is sewn on a belt or spliced on a line and then beated again.

Code	L mm	O mm	UM	€
022252	52	8	PCS	
022265	65	10	PCS	

**Closed End Snap Hook**

316 Stainless Steel closed end spring gate jib snap hook. Used for attaching the jib onto the bow eye bolt, it is sewn on a belt or spliced on a line.

Code	L mm	O mm	UM	€
0222350	50	7	PCS	
0222370	70	9	PCS	
0222310	100	14	PCS	

**Fixed Bail Snap Shackle**

316 Stainless Steel fixed bail spi snap shackle. Used for the spinnaker's or jib's sheets and halyards. The sheet/halyard may be spliced or knotted.

Code	L mm	O mm	UM	€
0222550	55	9	PCS	
0222560	75	12	PCS	
0222590	99	15	PCS	

**Swivel Snap Shackle**

316 Stainless Steel swivel spi snap shackle. Used for the spinnaker's or jib's sheets and halyards. The sheet/halyard may be spliced or knotted.

Code	L mm	O mm	UM	€
0222670	70	12	PCS	
0222690	90	16	PCS	
0222613	127	22	PCS	

**Clevis Pin Snap Shackle**

316 Stainless Steel swivel snap shackle with clevis pin. Used for the spinnaker's or jib's sheets and halyards. In case of spliced halyards, the shackle pin can be easily replaced if worn out.

Code	L mm	O mm	UM	€
0222770	74	12	PCS	
0222790	94	14	PCS	
0222713	138	22	PCS	

**MTM Open End Snap Hook**

High quality 316 Stainless Steel open end snap hook. Outstanding quality control and finish for the most rugged use in sea water. Supplied on elegant presentation card. Working Load (WL) tested and guaranteed. Breaking Load (BL) is 4 times Working Load.

Code	L mm	O mm	WL Kg	BL Kg	UM	€
022252C	50	9	90	360	PCS	
022265C	65	9	120	480	PCS	

**MTM Closed End Snap Hook**

High quality 316 Stainless Steel closed end snap. Outstanding quality control and finish for the most rugged use in sea water. Supplied on elegant presentation card. Working Load (WL) tested and guaranteed. Breaking Load (BL) is 4 times Working Load.

Code	L mm	O mm	WL Kg	BL Kg	UM	€
0222350C	50	7	65	260	PCS	
0222370C	70	9	125	500	PCS	
0222310C	100	14	225	900	PCS	

**MTM Fixed Bail Snap Shackle**

High quality 316 Stainless Steel fixed bail snap. Outstanding quality control and finish for the most rugged use in sea water. Supplied on elegant presentation card. Working Load (WL) tested and guaranteed. Breaking Load (BL) is 4 times Working Load.

Code	L mm	O mm	WL Kg	BL Kg	UM	€
0222560C	70	20	450	1800	PCS	
0222590C	100	20	830	3320	PCS	

**MTM Swivel Snap Shackle**

High quality 316 Stainless Steel swivel snap. Outstanding quality control and finish for the most rugged use in sea water. Supplied on elegant presentation card. Working Load (WL) tested and guaranteed. Breaking Load (BL) is 4 times Working Load.

Code	L mm	O mm	WL Kg	BL Kg	UM	€
0222670C	70	12	160	640	PCS	
0222690C	90	16	220	880	PCS	
0222613C	127	22	400	1600	PCS	

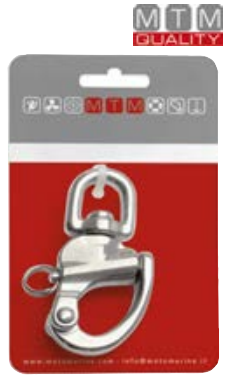
**MTM Clevis Pin Snap Shackle**

High quality grade 316 Stainless Steel snap shackle with clevis pin. Outstanding quality control and finish for the most rugged use in sea water. Supplied on elegant presentation plastic card. Working Load (WL) tested and guaranteed. Breaking Load (BL) is 4 times Working Load.

Code	L mm	O mm	WL Kg	BL Kg	UM	€
0222770C	74	12	160	640	PCS	
0222790C	94	12	220	880	PCS	
0222713C	138	22	400	1600	PCS	



Wire Eye Straps

Polished Stainless Steel wire stamped eye strap. Sold in 10 pcs pack.

Code	D mm	W mm	W1 mm	UM	€
0333340	4	40	10	PCS	
0333350	5	51	12	PCS	
0333360	6	60	14	PCS	
0333363	8	63	15	PCS	

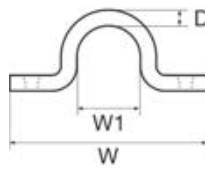

Stamped Eye Straps S

Narrow base stamped Stainless Steel eye straps. Sold in 10 pcs pack.

Code	W mm	W1 mm	UM	€
0333022	42	10	PCS	
0333024	47	14	PCS	
0333026	55	20	PCS	

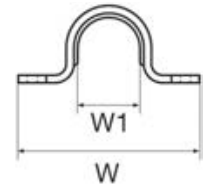

Stamped Eye Straps L

Large base stamped Stainless Steel eye straps. Sold in 10 pcs pack.

Code	W mm	W1 mm	UM	€
0333213	45	13	PCS	
0333216	48	16	PCS	

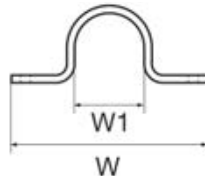

Stamped Eye Loops

Polished Stainless Steel wire stamped eye loop. Sold in 10 pcs pack.

Code	D mm	W mm	W1 mm	UM	€
0333355	5	78	40	PCS	
0333362	6	92	50	PCS	



Pad Eye 2

2 Holes Stainless Steel pad eye.

Code	D mm	L mm	W mm	UM	€
0235045	5	45	15	PCS	
0235060	6	60	20	PCS	
0235080	8	80	26	PCS	

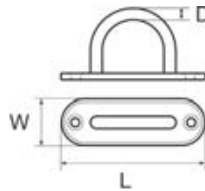

Pad Eye 4

4 Holes Stainless Steel pad eye.

Code	D mm	L mm	W mm	UM	€
0234035	5	35	30	PCS	
0234040	6	40	35	PCS	
0234050	8	50	40	PCS	

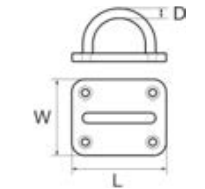

4 Holes Eye Plate

4 Holes Stainless Steel eye plate with O ring.

Code	W mm	L mm	O mm	D mm	H mm	UM	€
0234430	30	35	30	5	20	PCS	
0234435	35	40	40	6	26	PCS	
0234440	40	50	40	8	32	PCS	

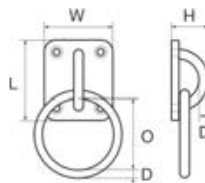

3 Holes Eye Plate

3 Holes Stainless Steel ring eye plate with underplate.

Code	L mm	W mm	D mm	UM	€
0234336	65	50	6	PCS	
0234338	68	50	8	PCS	

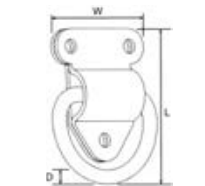

3 Holes Extra Eye Plate

Casted 3 holes Stainless Steel ring eye plate. Outstanding quality and finishing.

Code	L mm	W mm	D mm	UM	€
0234346	44	44	6	PCS	
0234348	55	55	8	PCS	
0234350	73	75	10	PCS	

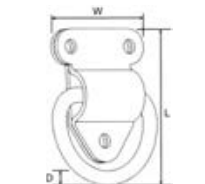

U Bolt P

Stainless Steel pinched wire U-Bolts.

Code	D mm	M mm	L mm	W mm	H mm	UM	€
0230004	4	4	64	30	30	PCS	
0230005	5	5	80	35	40	PCS	
0230006	6	6	90	35	40	PCS	
0230008	8	8	100	35	50	PCS	
0230010	10	10	130	50	55	PCS	
0230012	12	12	150	60	65	PCS	

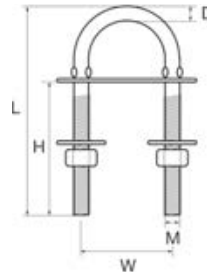

U Bolt S

Stainless Steel thickened wire U-Bolt.

Code	D mm	M mm	L mm	W mm	H mm	UM	€
0230105	6	5	78	36	48	PCS	
0230106	8	6	90	36	42	PCS	
0230108	10	8	100	45	52	PCS	
0230110	12	10	135	50	80	PCS	
0230112	14	12	150	60	85	PCS	

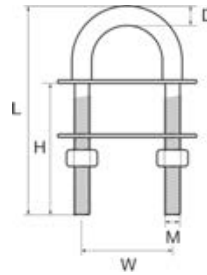

U Bolt Coat

Stainless Steel watertight seal PVC coated U-Bolt.

Code	D mm	M mm	L mm	W mm	H mm	UM	€
0230208	8	6	80	35	50	PCS	
0230210	10	8	100	40	65	PCS	
0230212	12	10	130	50	75	PCS	
0230214	14	12	155	63	90	PCS	

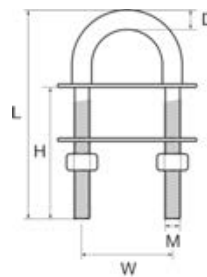

Wtight U-Bolt

Mirror polished Stainless Steel U-Bolt with welded watertight blocking base.

Code	D mm	M"	L mm	W mm	H mm	UM	€
0230410	9,5	3/8	100	36	63	PCS	
0230412	12,7	1/2	140	46	113	PCS	

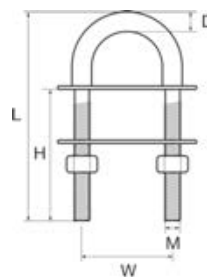

U Bolt G

Stainless Steel thickened wire U-Bolt with easy tightening self-gripping nuts.

Code	D mm	M mm	L mm	W mm	H mm	UM	€
0230118	10	8	100	40	60	PCS	
0230120	12	10	100	40	48	PCS	
0230122	14	12	120	50	58	PCS	

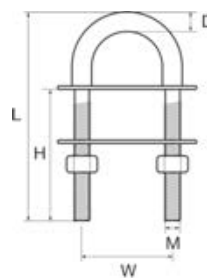

Welded Eye Bolt

Stainless Steel welded eye bolt.

Code	M mm	H mm	W mm	D mm	UM	€
0231040	6	40	13	6	PCS	
0231060	6	60	13	6	PCS	
0231180	8	70	17	8	PCS	
0231110	10	90	21	10	PCS	
0231112	12	105	25	12	PCS	

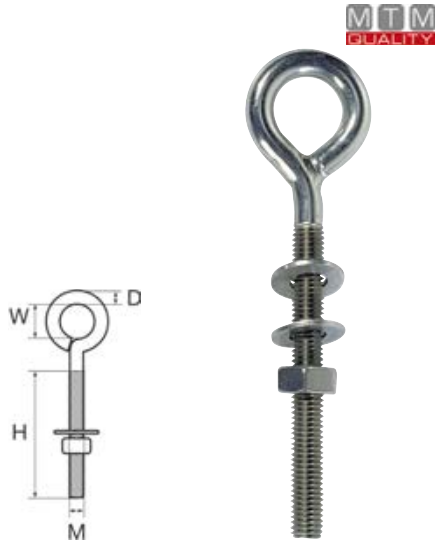

Turned Eye Bolt

Stainless Steel turned eye bolt.

Code	M mm	H mm	W mm	D mm	UM	€
0231240	6	40	12	5	PCS	
0231260	6	60	12	5	PCS	
0231280	8	80	14	6	PCS	
0231210	10	100	16	8	PCS	
0231212	12	140	18	10	PCS	

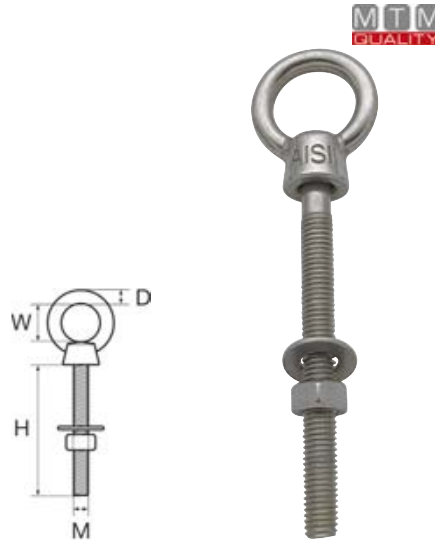

Double Eye Eye Bolt

Stainless Steel double eye bolt.

Code	M mm	H mm	W mm	D mm	UM	€
0233050	8	65	20	7	PCS	
0233080	10	85	25	8	PCS	

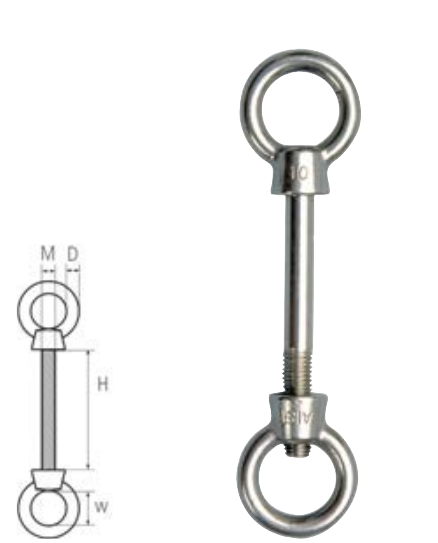

Male Eye Bolt

Stainless Steel male eye bolt.

Code	M mm	W mm	D mm	UM	€
0231606	6	15	6	PCS	
0231608	8	20	8	PCS	
0231610	10	25	10	PCS	
0231612	12	30	10	PCS	
0231616	16	35	14	PCS	



Eye Nut

Stainless Steel eye nut.

Code	M mm	W mm	D mm	UM	€
0231506	6	19	8	PCS	
0231508	8	19	8	PCS	
0231510	10	24	10	PCS	
0231512	12	28	12	PCS	
0231516	16	35	14	PCS	



Round Ring

Stainless Steel round ring.

Code	D mm	W mm	UM	€
0236020	3	20	PCS	
0236025	3	25	PCS	
0236028	4	25	PCS	
0236030	4	30	PCS	
0236040	5	40	PCS	
0236050	5	50	PCS	
0236055	6	50	PCS	
0236060	6	60	PCS	
0236065	8	60	PCS	
0236070	8	70	PCS	



Dee Ring

Stainless Steel Dee ring.

Code	D mm	W mm	L mm	UM	€
0236332	3	17	20	PCS	
0236333	3	22	26	PCS	
0236342	4	22	27	PCS	
0236343	4	25	30	PCS	
0236353	5	25	30	PCS	
0236354	5	34	40	PCS	
0236364	6	35	40	PCS	
0236365	6	50	47	PCS	



Triangle Ring

Stainless Steel triangle ring.

Code	D mm	L mm	UM	€
0236384	5	30	PCS	
0236385	6	40	PCS	
0236386	6	50	PCS	
0236388	8	50	PCS	



Dee Ring with Bar

Stainless Steel Dee ring with bar.

Code	D mm	L mm	H mm	UM	€
0236390	5	45	5,5	PCS	
0236391	6	50	7	PCS	
0236392	8	50	8	PCS	



Stainless Steel Hook

Stainless Steel stamped hook.

Code	L mm	W mm	H mm	UM	€
0332500	19	33	12	PCS	



Stainless Steel Classic Hook

Stainless Steel classic hook.

Code	L mm	W mm	H mm	UM	€
0331010	27	27	19	PCS	

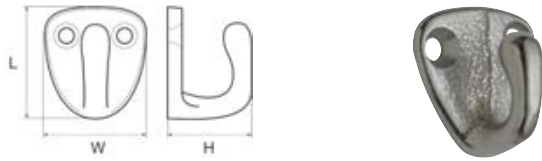

Stainless Steel Thin Hook

Stainless Steel thin hook.

Code	L mm	W mm	H mm	UM	€
0331009	39	17	31	PCS	



Stainless Steel Closed Hook

Stainless Steel closed hook.

Code	L mm	W mm	H mm	O mm	UM	€
0331300	35	30	21	10	PCS	



Stainless Steel Snap Hook

Stainless Steel spring hook for fenders and lines.

Code	L mm	W mm	H mm	A mm	UM	€
0331617	42	32	32	10	PCS	

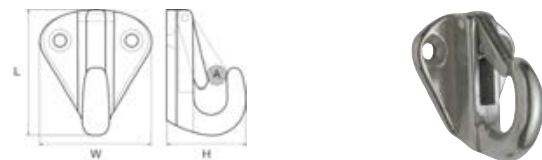

Double Tip Hook

Stainless Steel AISI 316-A4 double tip hook.

Code	L mm	W mm	UM	€
1113505	50	10	PCS	
1113508	80	10	PCS	



Chromed Brass Hook

Chromed Brass stamped hook.

Code	L mm	W mm	H mm	UM	€
0332501	19	33	12	PCS	

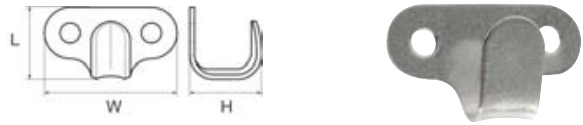

Chromed Brass Classic Hook

Chromed Brass classic hook.

Code	L mm	W mm	H mm	UM	€
0331000	25	23	19	PCS	

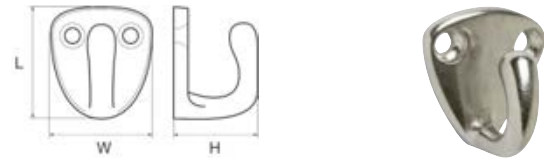

Chromed Thin Hook

Chromed Brass thin hook.

Code	L mm	W mm	H mm	UM	€
0331002	36	18	20	PCS	

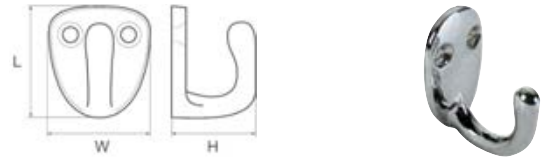

Chromed Brass Closed Hook

Chromed Brass closed hook.

Code	L mm	W mm	H mm	O mm	UM	€
0331301	30	30	19	9	PCS	

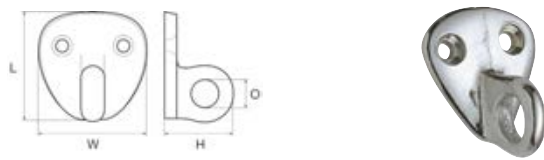

Chromed Brass Snap Hook

Chromed Brass spring hook for fenders and lines.

Code	L mm	W mm	H mm	A mm	UM	€
0331604	36	33	25	8	PCS	
0331607	43	33	33	10	PCS	

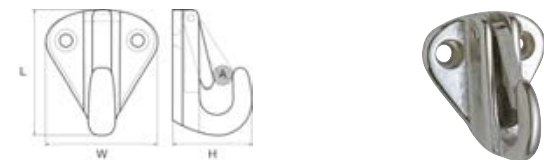

Light Weight Cleat

316 Stainless Steel flag-holder/cover-holder type cleat. 2 mounting holes base.

Code	L mm	Wheelbase mm	UM	€
1113506	67	10	PCS	
1113511	112	21	PCS	



New

Cup Hook

Chromed Brass cup hook.

Code	L mm	W mm	UM	€
0335502	47	18	PCS	

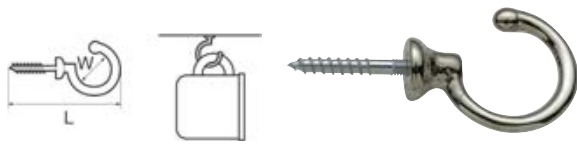

L Screw Hook

Stainless Steel L screw hook.

Code	L mm	H mm	UM	€
0333450	40	15	PCS	
0333460	45	20	PCS	
0333470	50	22	PCS	



Single Wardrobe Hook

Brass single wardrobe hook.

Code	Base mm	Brass	UM	€
0335601	15 x 40	Gold	PCS	
0335501	15 x 40	Chromed	PCS	



Triple Wardrobe Hook

Brass foldable wardrobe 3 hook.

Code	Base mm	Brass	UM	€
0335303	73 x 36	Gold	PCS	
0335305	73 x 36	Chromed	PCS	



Double Wardrobe Hook Long

Brass double wardrobe hook.

Code	Base mm	Brass	UM	€
0335308	75 x 70	Gold	PCS	
0335309	75 x 70	Chromed	PCS	



U Screw Hook

Stainless Steel U screw hook.

Code	L mm	W mm	UM	€
0333650	35	10	PCS	
0333660	41	12	PCS	
0333670	50	17	PCS	



O Screw Hook

Stainless Steel O screw hook.

Code	L mm	W mm	UM	€
0333850	33	7	PCS	
0333860	36	8	PCS	
0333870	46	10	PCS	



Double Wardrobe Hook

Brass double wardrobe hook.

Code	mm	Brass	UM	€
0335302	40 x 55	Gold	PCS	
0335301	40 x 55	Chromed	PCS	



Quadruple Wardrobe Hook

Brass foldable wardrobe 4 hook.

Code	Base mm	Brass	UM	€
0335304	73 x 36	Gold	PCS	
0335306	73 x 36	Chromed	PCS	

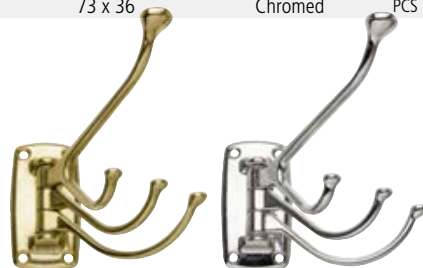

Flush Hook

Flush wardrobe hook.

Code	Base mm	Material	UM	€
0335605	80 x 25	Stainless Steel	PCS	
0335606	75 x 25	Chromed Brass	PCS	



Horizontal Nylon Hook

Horizontal Nylon hook. 10 pieces pack.

Code	L mm	W mm	H mm	Colour	UM	€
0332200	25	32	16	BLACK	PCS	
0332210	25	32	16	WHITE	PCS	

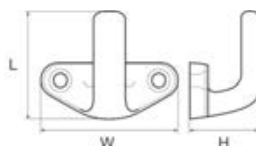

Vertical Nylon Hook

Vertical Nylon hook. 10 pieces pack.

Code	L mm	W mm	H mm	Colour	UM	€
0331901	40	18	16	BLACK	PCS	
0331902	40	18	16	WHITE	PCS	

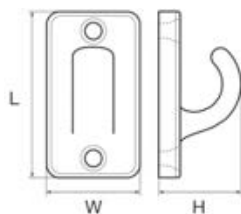

Oval Nylon Hook

Oval Nylon hook. 50 pieces pack.

Code	L mm	W mm	H mm	UM	€
0331900	39	19	17	PCS	

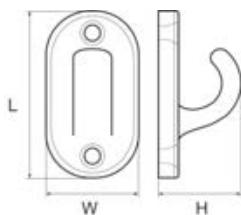

Eye Strap Nylon Hook

Nylon eye strap hook. 10 pieces pack.

Code	L mm	W mm	ø mm	Colour	UM	€
0332214	30	15	10	BLACK	PCS	
0332215	30	15	10	WHITE	PCS	

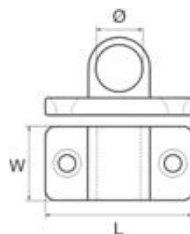

Line Hanger Nylon Hook

Nylon line hanger hook.

Code	L mm	W mm	H mm	UM	€
0332912	80	57	50	PCS	
0332913	95	57	65	PCS	



Line Holder Nylon Clamp Hook

Nylon line holder clamp hook for 22<->25 mm tubing.

Code	UM	€
0332915	PCS	



Clamp Nylon Hook

Nylon clamp hook for 22<->25 mm tubing.

Code	UM	€
0332910	PCS	

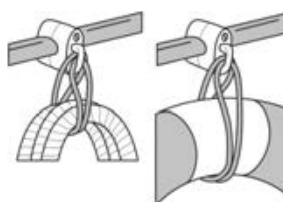

White Shock Cord Hook

White Nylon shock cord hook.

Code	Shock Cord ø mm	UM	€
0332804	4	PCS	
0332805	5*	PCS	
0332806	6	PCS	
0332808	8	PCS	
0332810	10	PCS	



Black Shock Cord Hook

Black Nylon shock cord hook.

Code	Shock Cord ø mm	UM	€
0332704	4	PCS	
0332705	5*	PCS	
0332706	6	PCS	
0332708	8	PCS	
0332710	10	PCS	



Flat Shock Cord Hook

Wide and flat Nylon hook for inflatables' sides. Sold in 10 pcs pack.

Code	Shock Cord ø mm	Colour	UM	€
0332600	6/8	BLACK	PCS	
0332610	6/8	WHITE	PCS	
0332620	6/8	GREY	PCS	

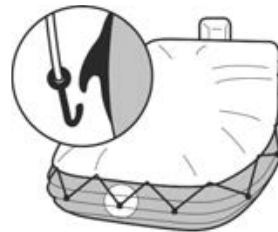

Autoblock Shock Cord Clip

Autoblock Nylon shock cord clip.

Code	Shock Cord ø mm	Colour	UM	€
0332835	5/6	BLUE	PCS	
0332836	5/6	BLACK	PCS	



Autoblock White Shock Cord Hook

Autoblock White Nylon shock cord hook.

Code	Shock Cord ø mm	UM	€
0332843	5<>6	PCS	
0332844	8	PCS	



Autoblock Black Shock Cord Hook

Autoblock Black Nylon shock cord hook.

Code	Shock Cord ø mm	UM	€
0332840	5<>6	PCS	
0332842	8	PCS	



Stainless Steel Shock Cord Hook

Stainless Steel shock cord hook.

Code	Shock Cord ø mm	UM	€
0332816	6	PCS	
0332818	8	PCS	
0332820	10	PCS	



Cabin Door Hook

Chromed Brass cabin door hook.

Code	mm	UM	€
0334708	80	PCS	



Stainless Steel Double Jointed Cabin Hook

Stainless Steel double jointed cabin door hook.

Code	mm	UM	€
0334820	100	PCS	



C.B. Barrel Bolt

Chromed Brass barrel bolt.

Code	mm	UM	€
0342412	115 x 25	PCS	

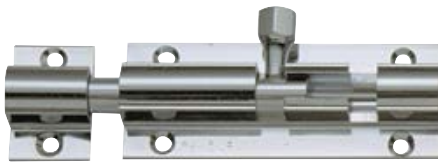

C.B. No Noise Smooth Handle Barrel Bolt

Chromed Brass barrel bolt with no noise black Nylon covered handle.

Code	mm	UM	€
0342491	85 x 30	PCS	



Tmarine Barrel Spring Latch

Mirror polished 316 Stainless Steel surface mount barrel bolt spring latch.

Code	A mm	B mm	C mm	D mm	UM	€
0342590	15	67	22	31	PCS	



Double Jointed Cabin Door Hook

Chromed Brass double jointed cabin door hook.

Code	mm	UM	€
0334806	60	PCS	
0334808	80	PCS	
0334810	100	PCS	



Door Latch

Chromed Brass door latch.

Code	mm	UM	€
0335233	52 x 33	PCS	



C.B. Smooth Barrel Bolt

Chromed Brass smoothed angles barrel bolt.

Code	mm	UM	€
0342459	59 x 27	PCS	
0342490	90 x 30	PCS	



Stainless Steel Smooth Barrel Bolt

Stainless Steel smooth barrel bolt.

Code	mm	UM	€
0342580	75 x 30	PCS	
0342581	90 x 38	PCS	



Tmarine Slide Latch

Mirror polished 316 Stainless Steel surface mount slide latch. Comfortable slide grip and low effort slide.

Code	A mm	B mm	C mm	D mm	E mm	F mm	UM	€
0342595	123	32	30	60	25	13	PCS	



Locking Hasp Spring Latch

Stainless Steel push-pull latch for lockers. Spring button with ring and padlock hole.



Code	L mm	Base mm	UM	€
0342101	56	50 x 34	PCS	

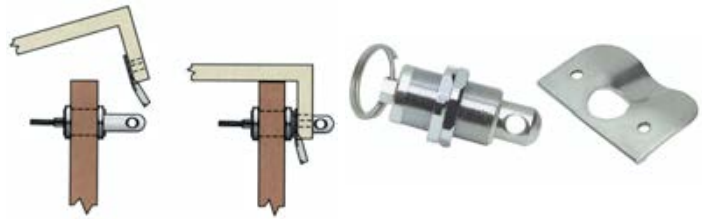

Pull Pin Spring Latch

316 Stainless Steel push-pull spring loaded pin latch for block or close lockers and boxes.



Code	A mm	B mm	C mm	D max mm	UM	€
0342104	9,5	56,2	28	18,5	PCS	



Sundecker Slam Latch

Pull-release Southco Sundecker slam latch for remote open/close hatches, lockers and boxes (simply pulling the strap). Orientable, mountable in any position, fast and easy installation. 1 Meter strap length.

Code	Dim mm	Strap L	Side	UM	€
0342730	53 x 115	1 m	North	PCS	
0342731	53 x 115	1 m	South	PCS	

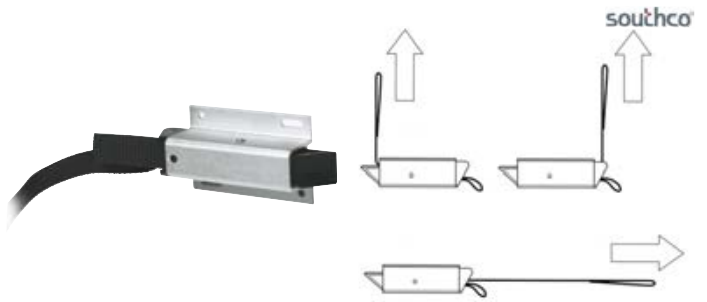
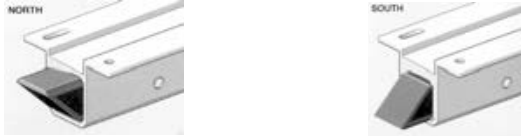

Snap In Slam Latch

Nylon and Rubber slam latch for hatches, lockers and boxes. Endowed with spacer to adjust the male catch height. Recessed base mounted on max 13 mm thickness bulkhead.

Code	Base Dim mm	Male Catch Dim mm	UM	€
0342760	ø 39 x H46	ø 13 x H14	PCS	



Snap Top Slam Latch

Nylon and Rubber slam latch for hatches, lockers and boxes. Endowed with spacer to adjust the male catch height. Base fixed on bulkhead surface.

Code	Base Dim mm	Male Catch Dim mm	UM	€
0342750	ø 21 x H20	ø 13 x H11<16	PCS	



Snap Side Slam Latch

Nylon and Rubber slam latch for hatches, lockers and boxes. Male catch is mounted on Stainless Steel bracket which can be fixed to the bulkhead at needed height. Base fixed on surface.

Code	Base Dim mm	S/Steel Bracket Dim mm	UM	€
0342752	ø 21 x H20	32 x 16 x D22	PCS	



Mini Cabinet Catch

Cabinet catch for drawers and cabinets. Plastic base and socket.

Code	Dim mm	UM	€
0342700	30 x 7	PCS	

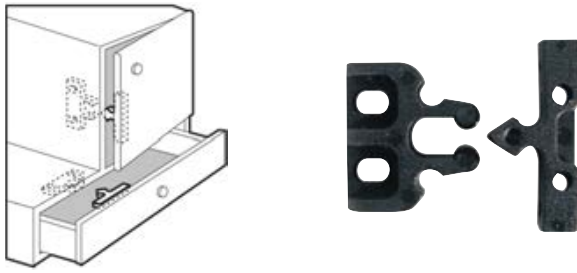

OCS Cabinet Catch

Cabinet catch for drawers and cabinets. Bronze base and socket.

Code	Dim mm	UM	€
0342801	45 x 8	PCS	

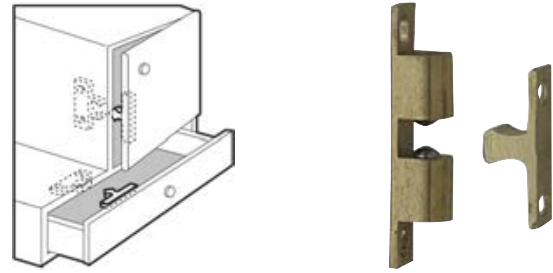

Grabber Cabinet Catch

Southco Grabber reinforced plastic cabinet catch for drawers and doors.



Code	Base Dim mm	UM	€
0342704	48 x 28 x H13	PCS	



Brass Elbow Latch

Brass elbow latch for doors and cabinets. Used with thru-hole handles or through a simple hole in the hatch.

Code	UM	€
0335015	PCS	

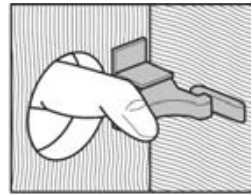

Snappy Slam Latch

Reinforced Plastic Southco Snappy slam latch. Auto-adjustable vibration resistant block.



Code	Dim mm	UM	€
0342710	37 x 38	PCS	



Parrot Slam Latch

Hidden or partially hidden Southco Parrot latch. Dampening pad eliminates the hard sound of a slammed hatch. Adjustable striker to have the latch always aligned. Reinforced Plastic body.



Code	Dim mm	UM	€
0342715	70 x 50	PCS	



CB Push Catch

Chromed Brass push catch for doors and hatches.

Code	Dim mm	UM	€
0342802	60 x 12	PCS	



SS Push Catch

Stainless Steel push catch for doors and hatches.

Code	Dim mm	UM	€
0342805	29 x 26	PCS	
0342806	40 x 32	PCS	



CG Push-to-Close Locking Latch

Flush mount push-to-close locking latch for hatches and bulkheads. Reinforced Plastic body.

MTM

Code	Internal ø mm	External ø mm	D mm	Key	UM	€
0342224	50	60	6<>12	No	PCS	
0342225	50	60	8<>12	Yes	PCS	

**Southco Push-to-Close Locking Latch**

Flush mount push-to-close Southco locking latch for hatches and bulkheads. Reinforced Plastic body.

southco

Code	Internal ø mm	External ø mm	D mm	Key	Colour	UM	€
0342244	50	60	6<>12	No	WHITE	PCS	
0342246	50	60	6<>12	Yes	WHITE	PCS	
0342243	50	60	6<>12	No	BLACK	PCS	
0342245	50	60	6<>12	Yes	BLACK	PCS	

**SS Push-to-Close Locking Latch**

Flush mount push-to-close locking latch for hatches and bulkheads. Mirror polished Stainless Steel body.

Code	Internal ø mm	External ø mm	D	Key	UM	€
0342233	50	60	6<>12	No	PCS	
0342234	50	60	6<>12	Yes	PCS	

**SS Evo Push-to-Close Locking Latch**

Push-to-close locking latch for hatches and bulkheads with larger handle for comfortable grip. Mirror polished Stainless Steel body, flush mount with watertight gasket.

Code	Ref	Hole Dim mm	External Dim mm	Door Thickness mm	UM	€
0342250	Round	ø 45	ø 57	9<>22	PCS	
0342252	Square	45 x 45	57 x 57	9<>22	PCS	



R1 Compression Latch

Stainless Steel round compression latch with adjustable cam bar. No visible screw holes, assembly with screws from the inside. Used for opening and closing hatches and bulkheads.

Code	A mm	D mm	C mm	T mm	UM	€
0341007	60<>75	50	79	5<>25	PCS	

**Q1 Compression Latch**

Stainless Steel square compression latch with adjustable cam bar. No visible screw holes, assembly with screws from the inside. Used for opening and closing hatches and bulkheads.

Code	A mm	D mm	B mm	C mm	T mm	UM	€
0341023	55<>75	60	63	78	8<>30	PCS	

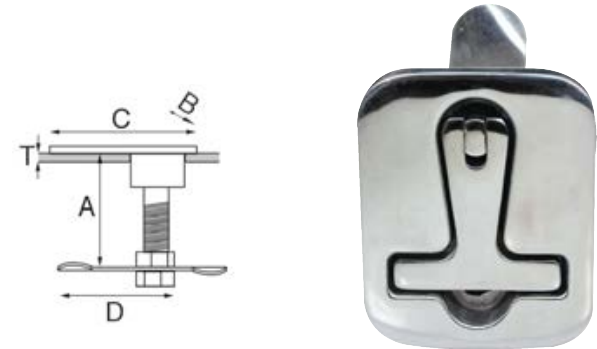
**Q2 Compression Latch**

Stainless Steel square compression latch with adjustable cam bar. Plate with visible screw holes, assembly with screws from outside. Used to open and close hatches and bulkheads.

Code	A mm	D mm	B mm	C mm	T mm	UM	€
0341025	55<>75	50	75	97	8<>30	PCS	

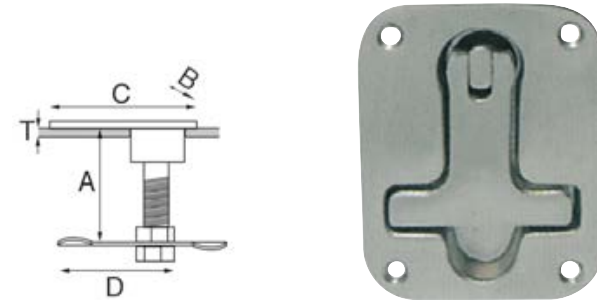
**Q4 Compression Latch**

316 Stainless Steel compression latch with flushed cover plate. Adjustable cam bar for opening and closing hatches and bulkheads.

Cod.	A mm	B mm	C mm	D mm	E mm	F mm	UM	€
0341020	110	115	91	51	15	75	PCS	

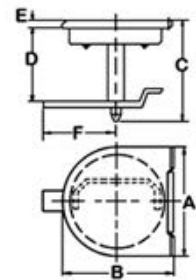
**R2 Compression Latch**

Stainless Steel round compression latch with adjustable cam bar. Visible plate with screw holes hidden by the handle, assembly with screws from outside. Used to open and close hatches and bulkheads.

Cod.	A mm	D mm	C mm	T mm	Key	UM	€
0341005	58<>69	50	78	5<>45	No	PCS	
0341015	58<>69	50	78	5<>45	Yes	PCS	

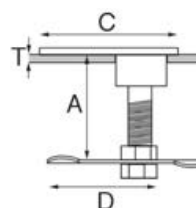

R3 Compression Latch

Stainless Steel compact square compression latch with adjustable cam bar. Visible plate with screw holes hidden by the handle, assembly with screws from outside. Used to open and close hatches and bulkheads. The cam bar can be mounted in normal position or turned (Rev) to cover all the required thicknesses (A).

Code	A mm	D mm	C mm	T mm	Key	UM	€
0341003	20<>45 (45<>65 Rev)	62	64	5<>45	No	PCS	
0341013	20<>45 (45<>65 Rev)	62	64	5<>45	Yes	PCS	



Q3 Compression Latch

Stainless Steel compact square compression latch with adjustable cam bar. Visible plate with screw holes hidden by the handle, assembly with screws from outside. Used to open and close hatches and bulkheads. The cam bar can be mounted in normal position or turned (Rev) to cover all the required thicknesses (A).

Code	A mm	B mm	C mm	D mm	T mm	Key	UM	€
0341004	20<>45 (45<>65 Rev)	64	64	60	8<>16	No	PCS	
0341014	20<>45 (45<>65 Rev)	64	64	60	8<>16	Yes	PCS	



Q-Evo Compression Latch

Compression latch for hatches and bulkheads with larger handle for comfortable grip. Mirror polished Stainless Steel body, adjustable cam bar, flush mount with screws from outside and watertight gasket. The cam bar can be mounted in normal position or turned (Rev) to cover all the required thicknesses (A).

Code	A mm	B mm	C mm	D mm	T mm	Key	UM	€
0341006	25<>43 (47<>63 Rev)	65	65	52	4<>42	No	PCS	
0341016	25<>43 (47<>63 Rev)	65	65	52	4<>42	Yes	PCS	



Southco M1-20 Compression Latch

High quality Stainless Steel IP65 watertight compression latch with adjustable cam bar. Used to open and close bulkheads and hatches. The cam bar can be mounted in normal position or turned (Rev) to cover all the required thicknesses (A).

Code	A mm	C1 mm	C mm	T mm	Key	UM	€
0341133	27<>40 (51<>64 Rev)	50	61,5	12<>22,5	No	PCS	
0341134	27<>40 (51<>64 Rev)	50	61,5	12<>22,5	Yes	PCS	



Southco M1-25 Compression Latch

High quality Stainless Steel IP65 watertight compression latch with adjustable cam bar. Used to open and close bulkheads and hatches. The cam bar can be mounted in normal position or turned (Rev) to cover all the required thicknesses (A).

Code	A mm	C1 mm	C mm	T mm	Key	UM	€
0341153	34<>48 (60<>75 Rev)	63,5	76	12<>22,5	No	PCS	
0341154	34<>48 (60<>75 Rev)	63,5	76	12<>22,5	Yes	PCS	



SS2 Flush Mount Stainless Steel Lifting Handle

Stainless Steel flush lifting handle.

Code	Dim mm	UM	€
0340456	55 x 75	PCS	
0340476	57 x 76	PCS	

**Flush Mount Stainless Steel S Lifting Handle**

Stamped Stainless Steel flush classic lifting handle.

Code	Dim mm	UM	€
0340438	38 x 40	PCS	
0340455	55 x 65	PCS	

**Stainless Steel Smooth Lifting Handle**

Stainless Steel flush round and square lifting handle.

Code	Dim mm	UM	€
0340481	ø 50	PCS	
0340482	50 x 50	PCS	

**Nylon Smooth Lifting Handle**

Nylon round flush mount lifting handle with larger handle for comfortable grip.

Code	Dim mm	UM	€
0340470	ø 51 x H6	PCS	

**Flush Mount Stainless Steel F Lifting Handle**

Casted Stainless Steel flush classic lifting handle.

Code	Dim mm	UM	€
0340434	38 x 48	PCS	

**SS Flush Ring Catch**

Stainless Steel flush mount ring catch for hatches and bulkheads.

Code	Dim mm	UM	€
0342205	57 x 40	PCS	

**SS Smooth Flush Catch**

Stainless Steel flush mount catch for hatches and bulkheads.

Code	Dim mm	UM	€
0342206	57 x 65	PCS	

**Lift Handle Camlock**

Stainless Steel flush mount lift handle for hatches and bulkheads. To be completed with camlock and keys.

Code	Dim mm	Accessories	UM	€
0342202	50 x 55		PCS	
0343316		Camlock H16 mm	PCS	
0343320		Camlock H20 mm	PCS	
0343325		Camlock H25 mm	PCS	
0343330		Camlock H30 mm	PCS	



BS1 Flush Mount Brass Lift Handle

Brass flush mount square lifting handle. Square grip.

Code	mm	Finishing	UM	€
0340675	74 x 50 x 8	POLISHED BRASS	PCS	
0340676	74 x 50 x 8	CHROMED BRASS	PCS	
0340696	92 x 63 x 9	POLISHED BRASS	PCS	
0340697	92 x 63 x 9	CHROMED BRASS	PCS	

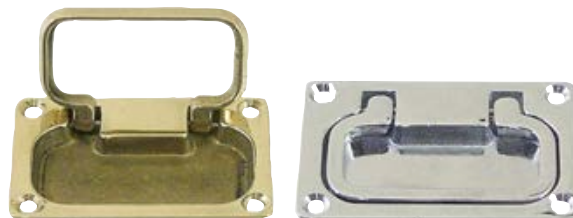
**BS2 Flush Mount Brass Lift Handle**

Brass flush mount square lifting handle. Bow grip.

Code	mm	Finishing	UM	€
0340674	70 x 43 x 13	POLISHED BRASS	PCS	
0340683	70 x 43 x 13	CHROMED BRASS	PCS	
0340684	80 x 49 x 13	POLISHED BRASS	PCS	
0340685	80 x 49 x 13	CHROMED BRASS	PCS	

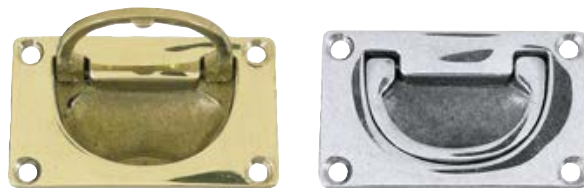
**PS1 Flush Mount Plastic Handle**

Reinforced Plastic flush mount compact handles.

Code	mm	Colour	UM	€
0341557	57 x 57	WHITE	PCS	
0341558	57 x 57	CREAM	PCS	

**PS2 Flush Mount Plastic Handle**

Reinforced Plastic flush handle.

Code	mm	UM	€
4010000	85 x 175	PCS	

**TS1 Flush Mount Teak Drawer Pull**

Flush mount Teak square drawer pull.

Code	mm	UM	€
0341265	65 x 40	PCS	

**Thru Mount Teak Drawer Pull**

Thru mount Teak drawer pull.

Code	ø mm	UM	€
0341230	30	PCS	

**Thru Mount Brass Drawer Pull**

Polished or Chromed Brass thru mount drawer pull.

Code	ø mm	Finishing	UM	€
0341326	32	POLISHED BRASS	PCS	
0341327	32	CHROMED BRASS	PCS	

**Globe Drawer Buttons**

Chromed Brass drawer buttons for cupboard doors.

Code	ø mm x H mm	UM	€
0340922	15 x 20	PCS	
0340932	18 x 20	PCS	

**Double-Cone Drawer Button**

Chromed Brass drawer button for cupboard doors.

Code	ø mm x H mm	UM	€
0340912	23 x 18	PCS	



Southco Smart Button Latch

Southco Pull-to-Open button latch: simply pull the knob to open or push the door to close. Knob stores flush and pops out with a simple touch. PC/ABS corrosion UV resistant body. Door thickness 1,5<>19 mm.

Code	Cutout ø mm	L mm	Door Thickness mm	Finishing	UM	€
0343250	32	47	1,5<>19	CHROMED	PCS	



southco

Southco Turn Knob Latch

Southco Turn-to-Pop-Out knob latch: the knob remains flushed when closed, but pops out with a touch to provide a secure grip to operate the latch and open or close the door. Turn the button to open, push the door to close. Self-adjusting keeper. UV corrosion resistant nut and body. For flush or surface mount doors assembly.

Code	ø mm	L mm	Door Thickness mm	Finishing	For Doors	UM	€
0343245	32	47	1,5<>19	CHROMED	Flush Mount	PCS	
0343246	32	47	1,5<>19	CHROMED	Surface Mount	PCS	

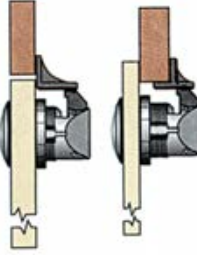

southco

Southco Point R Latch

Southco Push-to-Close point latch with flush knob and round flange. The pull knob is flushed when the door is closed and pops out when the door is opened. Black Nylon nut and housing, Brass knob and flange. To be completed with fix or adjustable keeper.

Code	ø mm	L mm	Door Thickness mm	Finishing	Keeper	UM	€
0343260	25	50	4<>25,4	CHROMED		PCS	
0343261	25	50	4<>25,4	SATIN		PCS	
0343271					Fixed	PCS	
0343272					Adjustable	PCS	

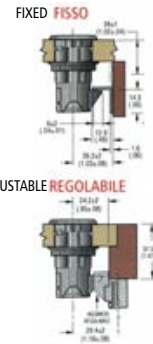

southco

Southco Point Q Latch

Southco Push-to-Close point latch with flush knob and square flange. The pull knob is flushed when the door is closed and pops out when the door is opened. Black Nylon nut and housing, Brass knob and flange. To be completed with fix or adjustable keeper.

Code	ø mm	L mm	Door Thickness mm	Finishing	Keeper	UM	€
0343265	25	50	4<>25,4	CHROMED		PCS	
0343266	25	50	4<>25,4	SATIN		PCS	
0343271					Fixed	PCS	
0343272					Adjustable	PCS	



southco

Novibra Panel Latch

Novibra panel latch for doors, hatches, drawers, lockers and similar type applications. Quick and easy installation, it helps to eliminate noise caused by engine vibration. Weatherproof face, PC/ABS corrosion UV resistant body.

Code	Cutout ø	L mm	Door Thickness	Cup	Handle	UM	€
0343254	38 mm	44,5	3<>22 mm	SATIN	SATIN	PCS	
0343255	38 mm	44,5	3<>22 mm	CHROMED	CHROMED	PCS	
0343256	38 mm	44,5	3<>22 mm	WHITE	WHITE	PCS	
0343259	38 mm	44,5	3<>22 mm	BLACK	BLACK	PCS	

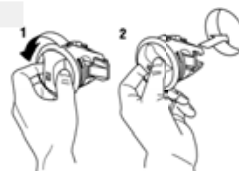

southco

F&S Compact Push Button Latch

F&S Button latch for hatches and drawers. Chromed Brass button, white Plastic case. Dimensions: 50 x 35 mm.



Code	Door Thickness mm	UM	€
0343113	>13<	PCS	
0343116	>16<	PCS	
0343119	>19<	PCS	

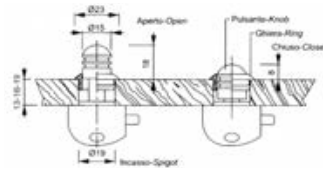

F&S Std Push Button Latch

F&S Plastic latch with Chromed Brass push buttons for hatches and drawers. To be completed with push button. Case latch dimensions: 70 x 50 mm.



Code	Latch	Button	UM	€
0343230	WHITE		PCS	
0343231	CHROMED		PCS	
0343213		∅ 23 mm for >13< mm Doors	PCS	
0343216		∅ 23 mm for >16< mm Doors	PCS	
0343219		∅ 23 mm for >19< mm Doors	PCS	
0343222		∅ 23 mm for >23< mm Doors	PCS	



Southco Key Button Latch

Reinforced Nylon and Resin housing Southco locking push-button key latch. Corrosion resistant, 302 Stainless Steel internal springs. Max door thickness 12.5 mm.



Code	∅ mm	L mm	Door Thickness mm	UM	€
0343284	25	40	1,5<>12,5	PCS	



Mini Camlocks with Keys

0343308 Pin lock with keys. Brass alloy pin and Stainless Steel sleeve.
0343309 Camlock with keys. Brass alloy pin and Stainless Steel sleeve.

Code	M mm	H mm	UM	€
0343308	12	10	PCS	
0343309	18	20	PCS	

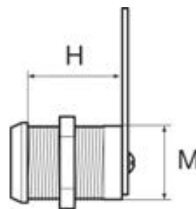

Camlock

Camlock with keys. Brass alloy cam and Stainless Steel sleeve. Chromed Steel cam bar.

Code	M mm	H mm	UM	€
0343316	19	16	PCS	
0343320	19	20	PCS	
0343325	19	25	PCS	
0343330	19	30	PCS	

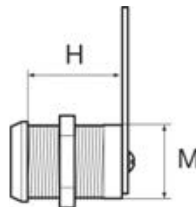

Compact Rim Lock

Compact rim lock with keys. Chromed Brass housing with rustproof elements. Surface or flush mount.

D = cylinder diameter
H = cylinder height

Code	Ref	mm	D mm	H mm	UM	€
0343348	30110 flush	58 x 55	19	22	PCS	
0343358	30111 external	58 x 55	19	22	PCS	



3.656P Rimlock With Knob

Rim lock set with keys, safety cam, flat striker and knurled knob to open from inside. Chromed Brass body and rustproof elements. Universal lock's R/L hand. Wheelbase 83 x 36 mm.

Code	mm	D mm	H mm	UM	€
0343362	98 x 58	20	25	PCS	
0343363	98 x 58	20	30	PCS	

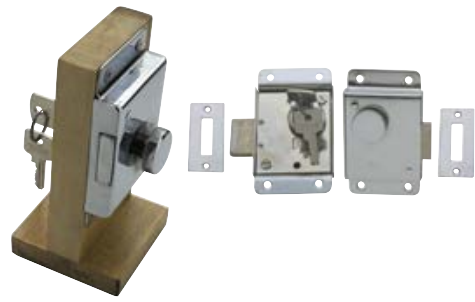
**3.656B Rimlock With Knob**

Rim lock set with keys, safety cam, boxed striker and knurled knob to open from inside. Chromed Brass body and rustproof elements. Universal lock's R/L hand.

Code	mm	D mm	H mm	UM	€
0343360	98 x 58	20	25	PCS	
0343361	98 x 58	20	30	PCS	

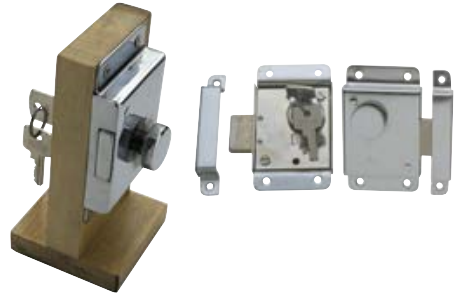
**4.062P Rimlock**

Rim lock with keys and flat striker. Chromed Brass body, rustproof elements. Handles to be ordered separately.

Code	mm	Hand	UM	€
0343382	112 x 46	R	PCS	
0343372	112 x 46	L	PCS	

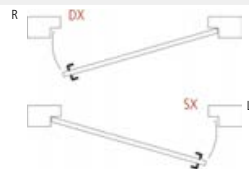
**4.062B Rimlock**

Rim lock with keys and boxed striker. Chromed Brass body, rustproof elements. Handles to be ordered separately.

Code	mm	Hand	UM	€
0343378	112 x 46	R	PCS	
0343379	112 x 46	L	PCS	

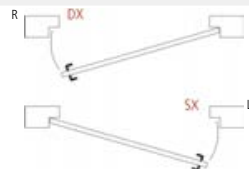
**4.021 Mortise Doorlock**

Mortise doorlock with keys and flat striker. Chromed Brass body, rustproof elements. Handles to be ordered separately.

Code	mm	Face Plate mm	Square Handle	Hand	UM	€
0343381	93 x 44 >12<	133 x 15	8 x 8 mm	R	PCS	
0343371	93 x 44 >12<	133 x 15	8 x 8 mm	L	PCS	

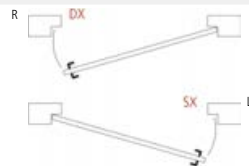
**2.035 Mortise Doorlock**

Mortise door lock with keys, handles and recessed flat striker. Chromed Brass body, rustproof elements and antivibration bolt.

Code	mm	Face Plate mm	Square Handle	Hand	UM	€
0343385	163 x 75 >13<	212 x 22	9 x 9 mm	R	PCS	
0343375	163 x 75 >13<	212 x 22	9 x 9 mm	L	PCS	

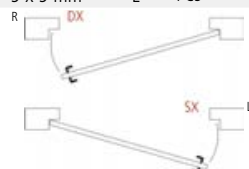

Omni Spring-Bolt Door Lock

Corrosion resistance materials mortise door lock. Easy installation: simply cut the shape on the door panel. Complete with recessed handles. Stainless Steel plates. Universal R/L lock's hand.

Code	mm	Door Thickness mm	Striker	UM	€
0345130	116 x 81,5	>12,7<		PCS	
0345131	116 x 81,5	>16<		PCS	
0344562			Striker (A = 3 mm)	PCS	
0344563			Striker (A = 5 mm)	PCS	
0344564			Striker (A = 7 mm)	PCS	

**40.9714 Mortise Door Lock**

Mortise door lock with flat striker and antivibration bolt. Chromed Brass body, rustproof elements. For thin doors. Handles to be ordered separately.

Code	mm	Hand	UM	€
0343345	68 x 60 >9<	R	PCS	
0343346	68 x 60 >9<	L	PCS	

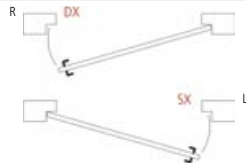
**4.020 Mortise Lockset**

Mortise door lock set for 15 mm door thickness. Complete with striker, Stainless Steel plates and handles.

Code	Plates mm	Hand	UM	€
0343520	80 x 70 >15<	R	PCS	
0343521	80 x 70 >15<	L	PCS	

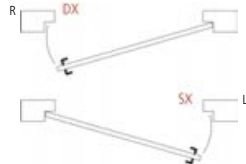
**4.023 Mortise Door Lock**

Mortise door lock with flat striker. Chromed Brass body, rustproof elements. Handles to be ordered separately.

Code	mm	Face Plate mm	Hand	UM	€
0343343	44 x 42,5 >12<	80 x 15	R	PCS	
0343344	44 x 42,5 >12<	80 x 15	L	PCS	

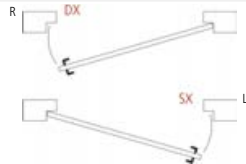
**Rotating Handle Doorlock**

Chromed Brass rotating handle door lock with striker. To be installed as fridge handle, on doors, shutters and gates.

Code	mm	UM	€
0343820	157 x 30 x H35	PCS	

**Rotating Angled Handle Doorlock**

Chromed Brass rotating handle door lock with angled striker. To be installed as fridge handle, on doors, shutters and gates up to 30 mm.

Code	mm	UM	€
0343822	157 x 30 x H35	PCS	



3.656B Inner Dead-Bolt Rim Lock

Surface mount rim lock with inner dead-bolt and box striker. Chromed Brass body. Rustproof elements. Universal R/L lock's hand. Handles to be ordered separately.

Code	mm	UM	€
0343391	72 x 46	PCS	
0343390	98 x 58	PCS	

**3.656 Inner Dead-Bolt Rim Lock**

Surface mount rim lock with inner dead-bolt and flat striker. Chromed Brass body. Rustproof elements. Universal R/L lock's hand. Handles to be ordered separately.

Code	mm	UM	€
0343491	72 x 46	PCS	
0343490	98 x 58	PCS	

**70.1500 Inner Dead-Bolt Mortise Lockset**

Mortise lockset with inner dead-bolt and flat antivibrating striker. Chromed Brass body. Rustproof elements. Complete with handles and plates.

Code	mm	Hand	UM	€
0343392	68 x 60 >9<	R	PCS	
0343393	68 x 60 >9<	L	PCS	

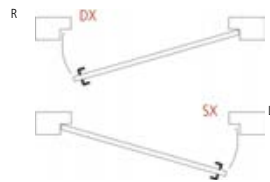
**Omni Spring-Bolt Inner Dead-Bolt Mortise Door Lock**

Corrosion resistant materials mortise door lock. With inner privacy dead-bolt. Easy installation: simply cut the shape on the door panel. Complete with recessed handles and Stainless Steel plates. Universal R/L lock's hand.

Code	mm	Door Thickness mm	Striker	UM	€
0345133	116 x 81,5	>12,7<		PCS	
0345134	116 x 81,5	>16<		PCS	
0344562			A = 3 mm	PCS	
0344563			A = 5 mm	PCS	
0344564			A = 7 mm	PCS	



southco

- SLIDING DOOR DOOR LOCKS -**Mobella Secure Latch**

Horizontal sliding door latch for doors and lockers. Stainless Steel and reinforced Composite body.

Code	Dimensions mm	Door Thickness mm	Colour	UM	€
0344520	55 x 87	>12<	BLACK	PCS	
0344521	55 x 87	>12<	WHITE	PCS	



southco

Mobella Flush Entry Doorlock

Anodized Aluminum sliding door mortise lockset, ideal even for retractable sliding doors (10-15 cm more door travel than other door locks). With keys and inner safety lock that prevents from getting locked in the cabin. Door thickness 12.5 mm or 10 mm with optional spacer. Universal R/L lock's hand.

Code	Cutout mm	Door Thickness	Finishing	Accessories	UM	€
0344510	63 x 114	>12,5< mm	ANODIZED		PCS	
0344511	63 x 114	>12,5< mm	LACQUERED		PCS	
0344512				Spacer 12,5 > 10 mm	PCS	

**Mobella Flush Oval Doorlock**

Stainless Steel sliding door mortise lockset, even for retractable sliding doors (10-15 cm more door travel than other door locks). With keys and inner safety lock that prevents from getting locked in the cabin. Door thickness 12.5 mm or 10 mm with optional spacer. Universal R/L lock's hand.

Code	Cutout mm	Door Thickness	Accessories	UM	€
0344516	63 x 114	>12,5< mm		PCS	
0344512			Spacer 12,5 > 10 mm	PCS	

**Mobella Flush Talon Doorlock**

Recessed doorlock for Aluminum, Wood or Fiberglass sliding doors. Great corrosion and salt resistance. With Positive-grip latch mechanism that keeps doors closed under even extreme conditions. Universal R/L lock's hand.

Code	Door Thickness mm	UM	€
0344812	23<>27	PCS	

**4.070 Mortise Lockset**

Sliding door mortise door lock with handles, flat striker, keys and Stainless Steel plates. Rustproof materials. Universal R/L lock's hand.

Code	Dim mm	Face Plate mm	Square Handle mm	UM	€
0343383	140 x 70 >12<	140 x 15	8 x 8	PCS	

**3.448 Mortise Lockset**

Sliding door mortise door lock with flush handles, flat striker, keys and Stainless Steel plates. Rustproof materials. Minimum door thickness 20 mm. Universal R/L lock's hand.

Code	mm	Face Plate mm	Door Thickness mm	UM	€
0343386	158 x 87	112 x 15	>20< Minimum	PCS	



Oval Knob Door Handles

Chromed Brass oval knob door handles.

Code	L mm	H mm	Square mm	UM	€
0343400	51	26	8	PCS	

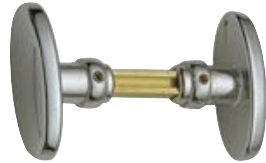
**Oval Knob and Ring Door Handles**

Oval Chromed Brass knob and ring door handles.

Code	L mm	H mm	Square mm	UM	€
0343401	51	26	8	PCS	

**Standard Door Handles**

Chromed Brass door handles with anti-tangle bending.

Code	L mm	H mm	Square mm	UM	€
0343402	80	36	8	PCS	

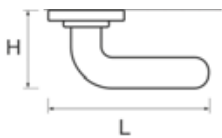
**Kata Door Handles**

Ergonomic Chromed Brass door handles.

Code	L mm	H mm	Square mm	UM	€
0343418	85	20	8	PCS	

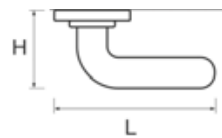
**Style Door Handles**

Chromed Brass design door handles.

Code	L mm	H mm	Square mm	UM	€
0343816	124	46	8	PCS	

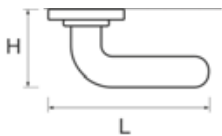
**Style 2 Door Handles**

Chromed Brass design door handles with insert.

Code	L mm	H mm	Square mm	UM	€
0343817	124	46	8	PCS	

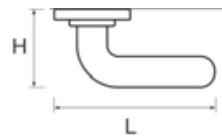
**No Catch 2 Door Handles**

Chromed Brass door handles with anti-tangle shaped ends.

Code	L mm	H mm	Square mm	UM	€
0343818	123	55	8	PCS	

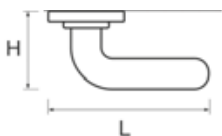
**No Catch 4 Door Handles**

Chromed Brass door handles with flush door mounting to avoid any tangling.

Code	L mm	H mm	Square mm	UM	€
0343819	133	42	8	PCS	

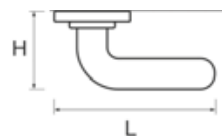
**Handle Rose**

Chromed Brass roses for handles.

Code	Ref	UM	€
0343410	Round	PCS	
0343412	Oval	PCS	

**Extra Handle Rose**

Chromed Brass extra rose for handles.

Code	ø mm	UM	€
0343415	60	PCS	



Chromed Brass Small Handle

Polished Chromed Brass small door handle.

Code	L mm	UM	€
0340807	75	PCS	

**Chromed Brass Handle**

Chromed Brass door handle. To be fixed from inside with 6 mm screws.

Code	L mm	H mm	UM	€
0340810	97	30	PCS	

**Stainless Steel Handle**

Stainless Steel door handle. Handle dia 10 mm, screw hole 5 mm.

Code	L mm	H mm	UM	€
0340814	143	38	PCS	

**Stainless Steel Grip Handle**

Mirror-Polished 316 Stainless Steel handles with ergonomic grip. To be fixed with two M6 through screws.

Code	L mm	H mm	UM	€
0340850	170	32	PCS	

**Stainless Steel Stud Handle**

Mirror polished Stainless Steel handle. Two 8 mm hidden studs mount.

Code	L mm	H mm	UM	€
0340819	170	40	PCS	

**Stainless Steel Screw Handle**

Mirror polished Stainless Steel handle. Through screw mount.

Code	L mm	H mm	UM	€
0340818	170	40	PCS	

**Short Handles**

Hard PVC short door handles (14 cm). Visible screw mounting.

Code	L mm	H mm	Colour	UM	€
0340710	140	40	GREY	PCS	
0340711	140	40	BLACK	PCS	
0340712	140	40	WHITE	PCS	

**Sidney Short Handles**

Reinforced core with soft PVC body short door handles (20 cm). Flush mounting through screws.

Code	L mm	H mm	Colour	UM	€
0340724	205	55	DARK GREY 7046	PCS	
0340726	205	55	LIGHT GREY 7035	PCS	



SS Push Catch

Stainless Steel push catch for doors and hatches.

Code	Dim mm	UM	€
0342805	29 x 26	PCS	
0342806	40 x 32	PCS	

**Hook Door Holder**

Chromed Brass hook door holder.

Code	A mm	B mm	UM	€
0336435	40	35	PCS	
0336445	50	45	PCS	

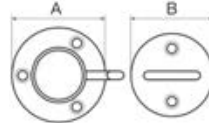
**Mag0 Magnetic Door Holder**

Chromed Brass magnetic door and cabinet holder with up to 20° adjustable magnet. Composed of two parts: one is mounted outside, the second is flushed.

Code	Dim mm	UM	€
0336101	∅ 39 x H26	PCS	

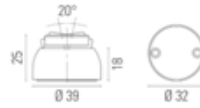
**Mag2 Magnetic Door Holder**

Chromed Brass magnetic door and cabinet holder with up to 20° adjustable body. Complete with matching plate.

Code	Dim mm	UM	€
0336107	∅ 39 x H70	PCS	

**Mag1 Magnetic Door Holder**

Magnetic door and cabinet holder. Composed of 2 magnets: the first with bracket base is to be mounted on the floor, the second is to be mounted on the door. Chromed Brass body.

Code	Dim mm	UM	€
0336102	∅ 39 x H40	PCS	

**Mag3 Magnetic Door Holder**

Stainless Steel magnetic door and cabinet holder. Composed of 2 magnets: the first with bracket base is to be mounted on the floor, the second is to be mounted on the door.

Code	A mm	B mm	C mm	D mm	E mm	UM	€
0336105	42	38	18	15	47	PCS	

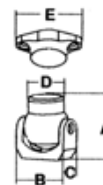
**Mag-PF1 Magnetic Door Holder**

Magnetic door and cabinet holder. Composed of 2 magnets: one is mounted outside, the second is flushed. Reinforced Plastic body. Holding power 2.5 Kg.

Code	L mm	L1 mm	H mm	H1 mm	UM	€
0336120	62	46	15	10	PCS	

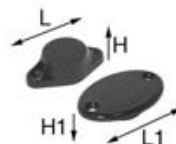

Lockable Standard Hold Down Clamp

Stainless Steel lockable lever hold down clamp.

Code	mm	UM	€
0343013	100 x 45	PCS	

**Lockable In-Line Mount Hold Down Clamp**

Stainless Steel lockable in-line mount hold down clamp.

Code	mm	UM	€
0343011	100 x 30	PCS	

**Lockable Vertical Mount Hold Down Clamp**

Stainless Steel vertical lever lockable in-line mount hold down clamp.

Code	mm	UM	€
0343012	100 x 30	PCS	

**Lockable Adjustable Hold Down Clamp**

Stainless Steel lockable adjustable lever hold down clamp.

Code	mm	UM	€
0343006	66<->75	PCS	
0343007	115<->125	PCS	

**Lockable Folding Fixed Eye Hold Down Clamp**

Stainless Steel lockable folding hold down clamp.

Code	mm	UM	€
0342028	71 x 28	PCS	

**Lockable Folding Swivel Eye Hold Down Clamp**

Stainless Steel lockable folding swivel eye hold down clamp.

Code	mm	UM	€
0342029	69 x 30	PCS	

**Lockable Folding Classic Hold Down Clamp**

Stainless Steel lockable classic folding hold down clamp.

Code	mm	UM	€
0342034	72 x 34	PCS	

**Folding Locking Hold Down Clamp**

Stainless Steel lockable folding hold down clamp with locking.

Code	mm	UM	€
0342200	76 x 34	PCS	



Lockable Hold Down Clamp

Chromed Brass lockable hold down clamp.

Code	mm	UM	€
0343003	100 x 45	PCS	

**Lockable Extra Hold Down Clamp**

Chromed Brass lockable hold down clamp with hidden screw holes.

Code	mm	UM	€
0343004	82 x 30	PCS	

**Vertical Mount Hold Down Clamp**

Chromed Brass vertical mount hold down clamp.

Code	mm	UM	€
0343002	70 x 35	PCS	

**In-Line Mount Hold Down Clamp**

Chromed Brass in-line mount hold down clamp.

Code	mm	UM	€
0343001	70 x 35	PCS	

**Double Swivel Lockable Hold Down Clamp**

Chromed Brass double swivel lockable hold down clamp.

Code	mm	UM	€
0342035	150 x 35	PCS	

**Hatch Butterfly Fastener**

Chromed Brass hatch and porthole butterfly knob fastener. Butterfly base dimensions: 38 x 15 mm. Wheelbase 26 mm. Striker dimensions: 40 x 22 mm. Wheelbase 10 mm.

Code	mm	UM	€
0343100	40 x 38	PCS	

**Soft Hatch Latch**

Anti-vibration Thermoplastic Elastomer latch for hatches and chests. Stainless Steel latch, support and keeper.

Code	L Hooked mm	L Unhooked mm	Colour	UM	€
0343015	105	97,5	BLACK	PCS	
0343016	105	97,5	WHITE	PCS	

**Southco F7 Latch**

Flexible UV-resistant anti-vibration thermoplastic elastomer latch. Ideal for hatches and chests.

Code	A mm	B mm	C mm	D mm	UM	€
0343020	112	62	25	19	PCS	



Hardinox Standard Marine Padlocks

Mirror Polished Stainless Steel standard shackle padlocks. Tough, sturdy and safe, immune to salt and marine environment.

Code	A mm	B mm	E mm	D mm	C mm	UM	€
0344430	30	27.3	15.8	4.8	17.0	PCS	
0344440	40	33.0	22.6	6.4	23.8	PCS	
0344450	50	40.3	29.5	7.9	27.9	PCS	

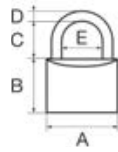

Hardinox Long Marine Padlocks

Mirror Polished Stainless Steel long shackle padlocks. Tough, sturdy and safe, immune to salt and marine environment.

Code	A mm	B mm	E mm	D mm	C mm	UM	€
0344433	30	27.3	15.8	4.8	32	PCS	
0344444	40	33.0	22.6	6.4	38	PCS	
0344455	50	40.3	29.5	7.9	49	PCS	

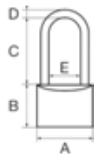

Padlock Set 4+1 Hardinox Master Key

Set of 5x30 mm Hardinox padlocks (4 standard padlocks + 1 long padlock). Universal key for all padlocks, provided in pairs for each padlock.

Code	A mm	B mm	E mm	D mm	C mm	C1 mm	UM	€
0344463	30.0	27.3	15.8	4.8	17.0	32.0	PCK	

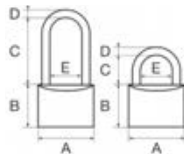

VSAFE Display Safe

Safe with user password keyboard, LED display (except 0344000) and internal LED light.

W = Width
L = Length
H = Height

Code	Dim mm	Weight Kg	UM	€
0344000	W310 x L200 x H200	4	PCS	
0344001	W350 x L270 x H250	11	PCS	
0344002	W420 x L370 x H200	13	PCS	
0344003	W508 x L380 x H200	15	PCS	



VSAFE Display Top Safe

Top opening drawer safe with user password keyboard, LED display and internal LED light.

W = Width
L = Length
H = Height

Code	Dim mm	Weight Kg	UM	€
0344004	W350 x L400 x H130	12	PCS	
0344005	W390 x L380 x H180	13	PCS	



Book Shaped Thin Hinge

Stainless Steel light book shaped hinges.

Code	D mm	W mm	H mm	UM	€
0401025	0.8	25	30	PCS	
0401035	0.8	35	40	PCS	
0401040	0.8	40	50	PCS	

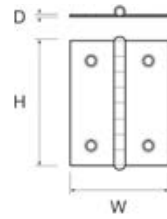

Book Shaped Standard Hinge

Stainless Steel standard book shaped hinges.

Code	D mm	W mm	H mm	UM	€
0401340	1.5	40	40	PCS	
0401360	1.5	40	60	PCS	
0401370	1.5	50	75	PCS	

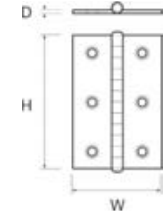

Book Shaped Medium Hinge

Stainless Steel medium size book shaped hinges.

Code	D mm	W mm	H mm	UM	€
0401380	1.5	60	80	PCS	
0401382	1.5	80	80	PCS	

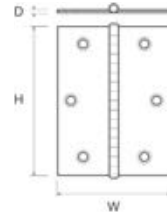

Book Shaped Large Hinge

Stainless Steel big size book shaped hinge.

Code	D mm	W mm	H mm	UM	€
0401385	2	100	100	PCS	

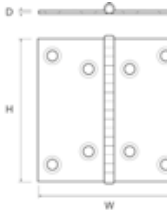

Bisquit Shaped Hinge

Stainless Steel bisquit shaped hinge.

Code	mm	UM	€
0400075	H40 x L70	PCS	

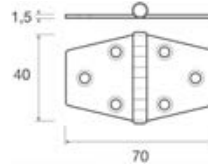

Excenter Hinge

Stainless Steel eccentric hinge.

Code	mm	UM	€
0402057	H40 x L55	PCS	

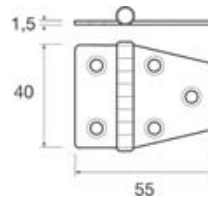

Offset Short Hinge

Stainless Steel short offset eccentric hinge.

Code	mm	UM	€
0403550	H40 x L55	PCS	

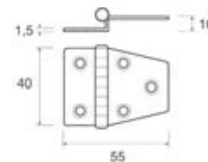

180° Folding Hinge

Stainless Steel 180° folding hinge for table tops and lockers.

Code	mm	UM	€
0402208	H30 x L86	PCS	

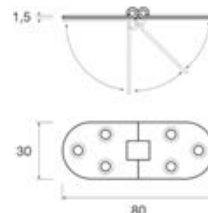

S Square Hinge

Mirror-Polished Stainless Steel small square hinges.

Standard = Upper Hingepin

Centerpin = Central Hingepin

Code	Ref	mm	UM	€
0450036	Standard	H40 x L37	PCS	
0450136	Centerpin	H40 x L37	PCS	

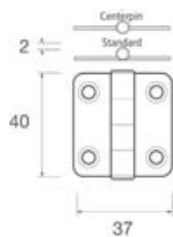

SQ/S Bisquit Shaped Hinge

Mirror-Polished Stainless Steel small bisquit shaped hinges with squared off corners.

Standard = Upper Hingepin

Centerpin = Central Hingepin

Reverse = Lower Hingepin

Code	Ref	mm	UM	€
0450037	Standard	H43 x L38+38	PCS	
0450137	Centerpin	H43 x L38+38	PCS	
0450237	Reverse	H43 x L38+38	PCS	

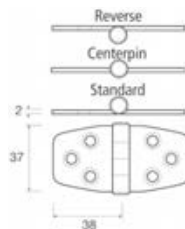

SR/S Bisquit Shaped Hinge

Smooth edges Mirror-Polished Stainless Steel bisquit shaped hinges.

Standard = Upper Hingepin

Centerpin = Central Hingepin

Reverse = Lower Hingepin

Code	Ref	mm	UM	€
0450039	Standard	H39 x L37+37	PCS	
0450139	Centerpin	H39 x L37+37	PCS	
0450239	Reverse	H39 x L37+37	PCS	

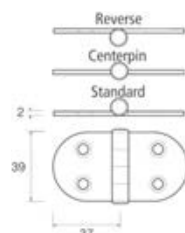

SQ/M Bisquit Shaped Hinge

Mirror-Polished Stainless Steel medium bisquit shaped hinge with squared off corners.

Code	mm	UM	€
0450060	H60 x L37+37	PCS	

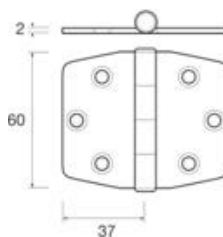

SQ/L Bisquit Shaped Hinge

Mirror-Polished Stainless Steel large bisquit shaped hinge with squared off corners.

Code	mm	UM	€
0450075	H75 x L37+37	PCS	

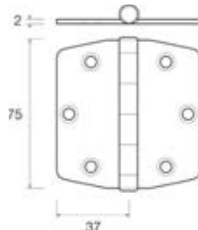

Oval Standard Hinge

Mirror-Polished Stainless Steel oval hinges.

Code	mm	UM	€
0456602	H35 x L51	PCS	
0456604	H48 x L67	PCS	
0456606	H56 x L78	PCS	



Oval Extra Hinge

Mirror-Polished Stainless Steel oval hinges.

Code	Ref	mm	UM	€
0456607	Big	H56 x L90	PCS	
0456610	Excenter	H56 x L84	PCS	
0456612	Long	H56 x L78	PCS	



Wing Hinge S

Mirror-Polished Stainless Steel small double wing hinge.

Code	mm	UM	€
0452210	H27 x L50+50	PCS	

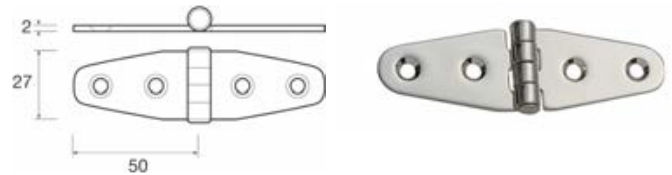
**Wing Hinge M**

Mirror-Polished Stainless Steel medium double wing hinges.

Standard = Upper Hingepin
Centerpin = Central Hingepin

Code	Ref	mm	UM	€
0452213	Standard	H39 x L70+70	PCS	
0452313	Centerpin	H39 x L70+70	PCS	

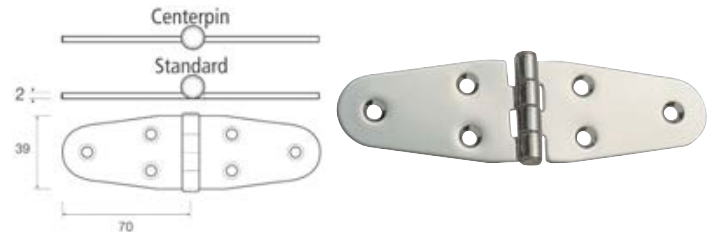
**Wing Hinge L**

Mirror-Polished Stainless Steel large double wing hinge.

Code	mm	UM	€
0452218	H40 x L90+90	PCS	

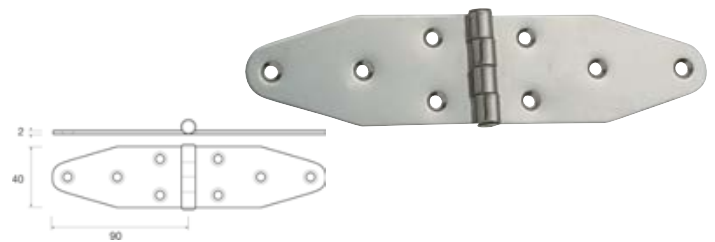
**Eccentric Hinge S**

Mirror-Polished Stainless Steel small eccentric hinges.

Standard = Upper Hingepin
Reverse = Lower Hingepin

Code	Ref	mm	UM	€
0452508	Standard	H40 x L36+19	PCS	
0452708	Reverse	H40 x L37+22	PCS	

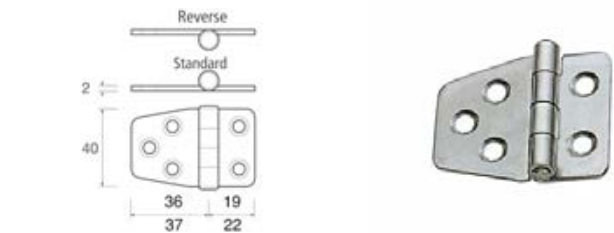
**Eccentric Hinge M**

Mirror-Polished Stainless Steel medium eccentric hinge.

Code	mm	UM	€
0452512	H39 x L70+30	PCS	

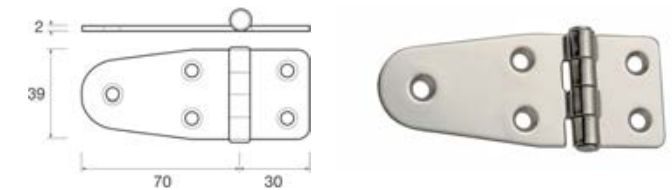
**Eccentric Hinge R**

Smooth edges Mirror-Polished Stainless Steel medium eccentric hinges.

Standard = Upper Hingepin
Centerpin = Central Hingepin

Code	Ref	mm	UM	€
0452516	Standard	H39 x L70+37	PCS	
0452616	Centerpin	H39 x L70+37	PCS	

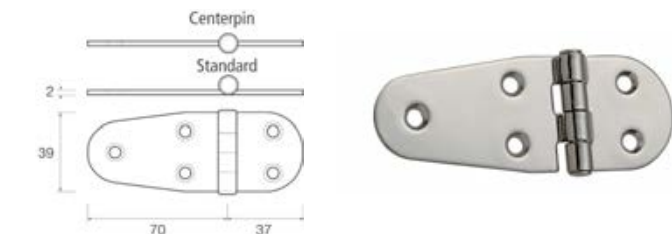
**Eccentric Hinge L**

Mirror-polished Stainless Steel large eccentric hinge.

Code	mm	UM	€
0452519	H40 x L39+90	PCS	



Offset Mini Hinge

Stainless Steel small offset hinge.

Code	mm	UM	€
0403535	H37,5 x L38	PCS	

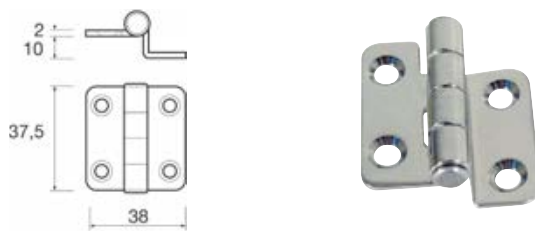

Offset Long Hinge

Standard Stainless Steel long offset eccentric hinges.

Code	mm	H mm	UM	€
0403560	H38 x L65	10	PCS	
0403561	H38 x L65	24	PCS	

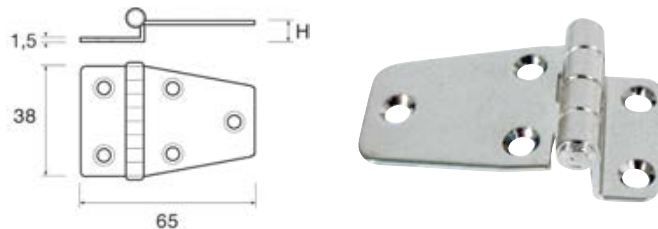

Low Offset Hinge

Stainless Steel low offset hinge for hatches.

Code	mm	UM	€
0453524	H40 x L95+42	PCS	

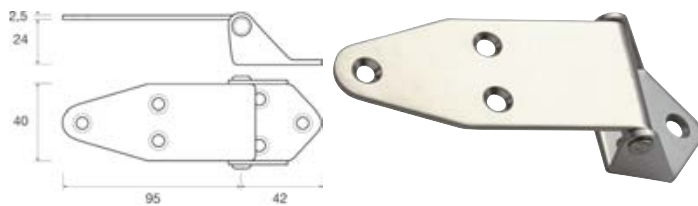

High Offset Hinge

Stainless Steel high offset hinge for hatches.

Code	mm	UM	€
0453534	H40 x L95+42	PCS	

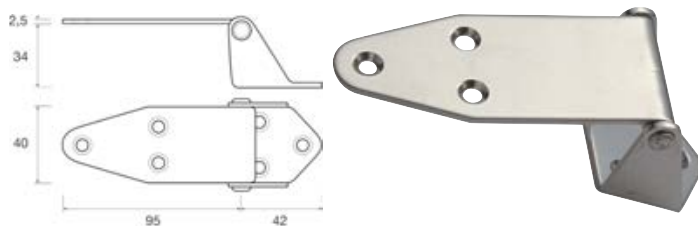

Low Offset Stamped Hinge

Stamped Stainless Steel low offset hinge for hatches.

Code	mm	UM	€
0453620	H40 x L50+81	PCS	



High Offset Stamped Hinge

Stamped Stainless Steel high offset hinge for hatches.

Code	mm	UM	€
0453635	H40 x L50+81	PCS	

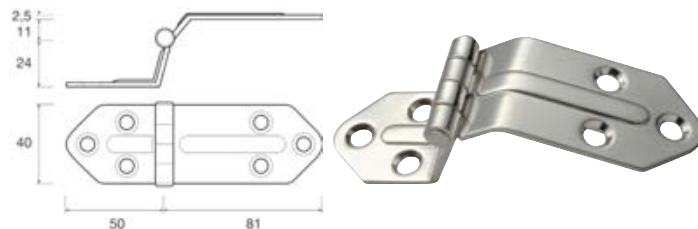

Classic Hinge for Hatches

Mirror-Polished 316 Stainless Steel base covered classic hinge for hatches.

Code	Dim mm	Wall Mount mm	Door Mount mm	UM	€
0453000	57 x 30 x H10	26 x 30	30 x 30	PCS	



Eccentric Hinge for Hatches

Mirror-Polished 316 Stainless Steel offset hinge for big pigot hatches.

Code	mm	UM	€
0453010	H43 x L33	PCS	

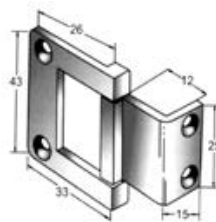

Bar Hinges

Stainless Steel 2 meters bar hinges.

Code	D mm	W mm	L m	UM	€
0420025	0.8	25	2	PCS	
0420032	0.8	32	2	PCS	
0420040	0.8	40	2	PCS	

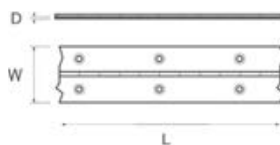

- STAINLESS STEEL MIRROR-POLISHED LIFT OFF HINGES -

Offset Excenter Hinge

Mirror-Polished Stainless Steel offset lift-off eccentric hinges.

Code	Direction	mm	UM	€
0455505	R	H37 x L48+18	PCS	
0455504	L	H37 x L48+18	PCS	

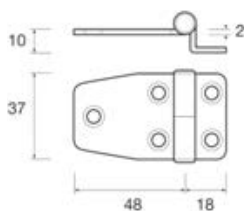

Offset Square Hinge S

Mirror-Polished Stainless Steel 2 levels lift-off hinges. Enable 180° full opening of doors and hatches.

Code	Direction	mm	UM	€
0456540	R	H40 x L19+16	PCS	
0456539	L	H40 x L19+16	PCS	

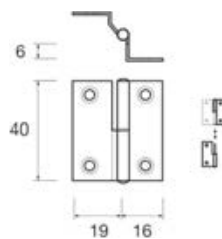

Offset Square Hinge L

Mirror-Polished Stainless Steel 2 level lift-off hinges. Enable 180° full opening of doors and hatches.

Code	Direction	mm	UM	€
0456555	R	H55 x L19+16	PCS	
0456554	L	H55 x L19+16	PCS	

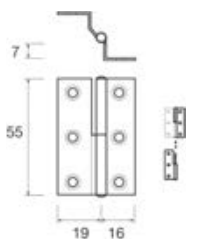

Lift-Off Hinge S

Mirror-Polished Stainless Steel compact lift-off hinges.

Code	Direction	mm	UM	€
0455508	R	H85 x L37+19	PCS	
0455507	L	H85 x L37+19	PCS	

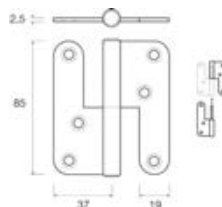

Lift-Off Hinge L

Mirror-Polished Stainless Steel lift-off hinges.

Code	Direction	mm	UM	€
0455512	R	H110 x L49+25	PCS	
0455511	L	H110 x L49+25	PCS	

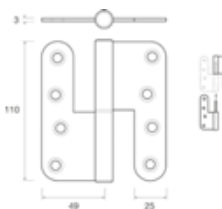

Square Shaped Extrastrong Hinge M

Mirror-Polished Stainless Steel extra strong square medium hinge. 3 mm thickness.

Code	mm	UM	€
0452902	H50 x L52	PCS	



Bisquit Shaped Extrastrong Hinge S

Mirror-Polished Stainless Steel extra strong small bisquit shaped hinge. 3 mm thickness.

Code	mm	UM	€
0452904	H38 x L75	PCS	



Bisquit Shaped Extrastrong Hinge M

Mirror-Polished Stainless Steel extra strong bisquit shaped hinge. 3 mm thickness.

Code	mm	UM	€
0452910	H38 x L105	PCS	



Excenter Extrastrong Hinge M

Mirror-Polished Stainless Steel extra strong eccentric hinge. 3 mm thickness.

Code	mm	UM	€
0452911	H38,5 x L67,2+41	PCS	



Wing Extrastrong Hinge M

Mirror-Polished Stainless Steel extra strong double wing hinge. 3 mm thickness.

Code	mm	UM	€
0452914	H38 x L142	PCS	



Offset Extrastrong Hinge M

Mirror-Polished Stainless Steel extra strong lift-off eccentric hinge. 3 mm thickness.

Code	mm	UM	€
0452923	H37,5 x L52,5+16	PCS	

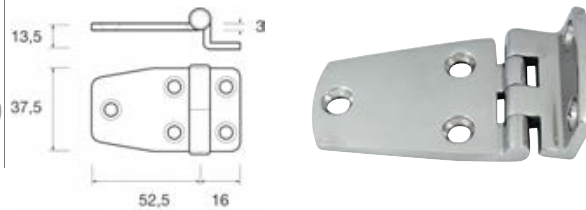

Quadra Hinge

Mirror-Polished Stainless Steel covered square hinge.

Code	mm	UM	€
0452804	H36,5 x L35,7	PCS	

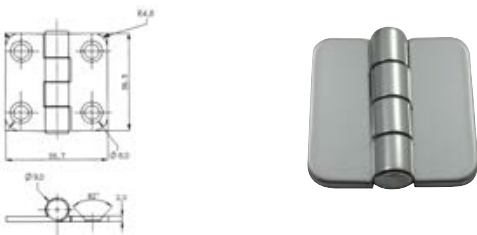

Bisquit Shaped Hinge L

Mirror-Polished Stainless Steel big covered bisquit shaped hinge.

Code	mm	UM	€
0452817	H75 x L74	PCS	

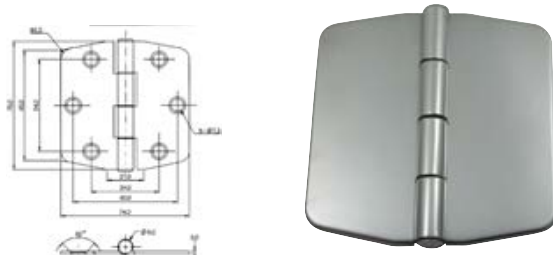

Bisquit Shaped Hinge S

Mirror-Polished Stainless Steel covered biscuit shaped hinge.

Code	mm	UM	€
0452807	H36,5 x L76,2	PCS	

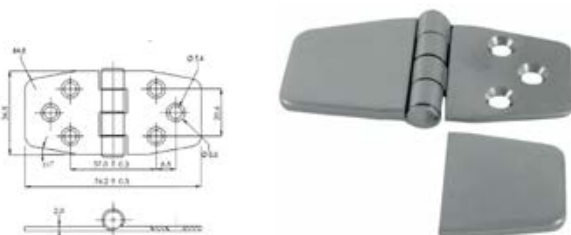

Excenter Hinge S

Mirror-Polished Stainless Steel covered eccentric hinge.

Code	mm	UM	€
0452808	H36,5 x L56,7	PCS	

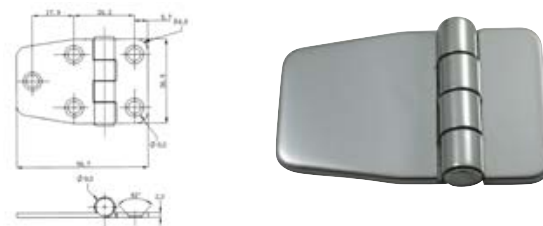

S Slim Flush Hinge

Mirror-Polished Stainless Steel flush hinge. Screw fixing from inside.

Code	mm	UM	€
0453018	70 x 35	PCS	

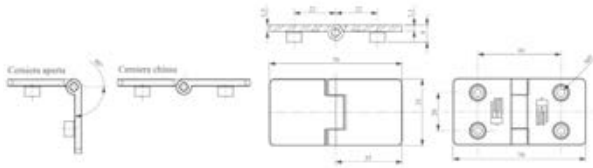

M Slim Flush Hinge

Mirror-Polished Stainless Steel flush hinge. Screw fixing from inside.

Code	mm	UM	€
0453011	70 x 65	PCS	

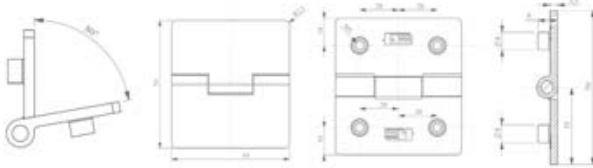

Excenter S Slim Flush Hinge

Mirror-Polished Stainless Steel flush excenter hinge. Screw fixing both from inside and outside.

Code	mm	UM	€
0453017	55 x 35	PCS	

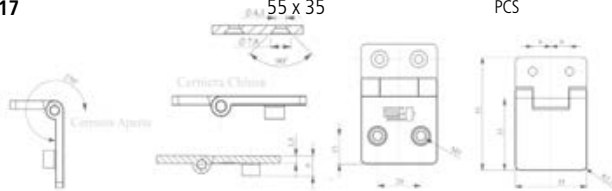

Excenter M Slim Flush Hinge

Mirror-Polished Stainless Steel flush excenter hinge. Screw fixing both from inside and outside.

Code	mm	UM	€
0453012	65 x 55	PCS	

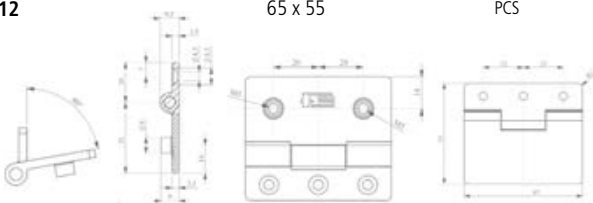

Excenter M Flush Hinge

Mirror-Polished Stainless Steel flush excenter hinge. Screw fixing both from inside and outside.

Code	mm	UM	€
0453014	70 x 30	PCS	

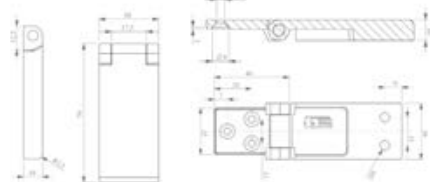

Excenter S Flush Hinge

Mirror-Polished Stainless Steel flush excenter hinge. Screw fixing both from inside and outside.

Code	mm	UM	€
0453013	45 x 30	PCS	

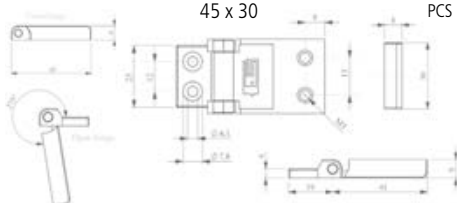

Classic Lift Off Hinge

Chromed Brass classic lift-off centerpin hinges.

Code	mm	Ref	UM	€
0410006	60 x 50	R	PCS	
0410005	60 x 50	L	PCS	



Standard Offset Hinge

Chromed Brass flat crank hinge.

Code	mm	H mm	UM	€
0413509	96 x 59	10	PCS	



Ladder Hinge

Chromed Brass hinge for folding ladders.

Code	mm	UM	€
0412514	145 x 20	PCS	



Flat Lift Off Hinge

Chromed Brass flat lift-off hinges.

Code	mm	Ref	UM	€
0410010	100 x 30	R	PCS	
0410009	100 x 30	L	PCS	



Long Offset Hinge

Chromed Brass high and long crank hinge.

Code	mm	H	UM	€
0413513	135 x 58	40	PCS	



Ladder Hook & Plate

Chromed Brass ladder hook and plate.

Code	Ref	UM	€
0422515	Ladder Hook	PCS	
0422516	Ladder Hook Plate	PCS	



- REINFORCED PLASTIC HINGES -

Bisquit Shaped Hinge 40x63

Reinforced Plastic bisquit shaped hinges.

Code	mm	Colour	UM	€
0430006	40 x 63	BLACK	PCS	
0430026	40 x 63	WHITE	PCS	



Bisquit Shaped Hinge 60x95

Reinforced Plastic bisquit shaped hinges.

Code	mm	Colour	UM	€
0430009	60 x 95	BLACK	PCS	
0430029	60 x 95	WHITE	PCS	



Oval Hinge 40x70

Reinforced Plastic oval hinges.

Code	mm	Colour	UM	€
0430007	40 x 70	BLACK	PCS	
0430027	40 x 70	WHITE	PCS	



Wing Hinge 40x100

Reinforced Plastic double wing hinges.

Code	mm	Colour	UM	€
0430410	40 x 100	BLACK	PCS	
0430430	40 x 100	WHITE	PCS	



Hex Head Machine Screws DIN 933

Stainless Steel DIN 933 A2 metric hex head machine screws.



Code	mm	Pack / Pcs	UM	€
609330052010	5x20	100	PCK	
609330053010	5x30	100	PCK	
609330053505	5x35	50	PCK	
609330054005	5x40	50	PCK	
609330055005	5x50	50	PCK	
609330062005	6x20	50	PCK	
609330063005	6x30	50	PCK	
609330063505	6x35	50	PCK	
609330064005	6x40	50	PCK	
609330065005	6x50	50	PCK	
609330066005	6x60	50	PCK	
609330067002	6x70	20	PCK	
609330068002	6x80	20	PCK	
609330610002	6x100	20	PCK	
609330082005	8x20	50	PCK	
609330083005	8x30	50	PCK	
609330084005	8x40	50	PCK	
609330085005	8x50	50	PCK	
609330086002	8x60	20	PCK	
609330087002	8x70	20	PCK	
609330088002	8x80	20	PCK	
609330810001	8x100	10	PCK	
609330103002	10x30	20	PCK	
609330104002	10x40	20	PCK	
609330105002	10x50	20	PCK	
609330106002	10x60	20	PCK	
609330107002	10x70	20	PCK	
609330108002	10x80	20	PCK	
609331010001	10x100	10	PCK	
609330128001	12x80	10	PCK	
609331210001	12x100	10	PCK	
609331212001	12x120	10	PCK	

Slotted Flat Head Machine Screws DIN 963

Stainless Steel DIN 963 A2 metric slotted head machine screws.



Code	mm	Pack / Pcs	UM	€
609630031410	3x14	100	PCK	
609630032010	3x20	100	PCK	
609630032510	3x25	100	PCK	
609630033010	3x30	100	PCK	
609630042010	4x20	100	PCK	
609630042510	4x25	100	PCK	
609630043010	4x30	100	PCK	
609630043510	4x35	100	PCK	
609630044010	4x40	100	PCK	
609630045010	4x50	100	PCK	
609630052010	5x20	100	PCK	
609630052510	5x25	100	PCK	
609630053010	5x30	100	PCK	
609630053505	5x35	50	PCK	
609630054005	5x40	50	PCK	
609630055005	5x50	50	PCK	
609630056005	5x60	50	PCK	
609630062005	6x20	50	PCK	
609630063005	6x30	50	PCK	
609630064005	6x40	50	PCK	
609630065005	6x50	50	PCK	
609630066005	6x60	50	PCK	
609630068002	6x80	20	PCK	
609630610002	6x100	20	PCK	
609630083005	8x30	50	PCK	
609630084005	8x40	50	PCK	
609630085005	8x50	50	PCK	
609630086002	8x60	20	PCK	
609630088002	8x80	20	PCK	
609630810001	8x100	10	PCK	

Socket Head Machine Screws DIN 912

Stainless Steel DIN 912 A2 metric socket head machine screws.



Code	mm	Pack / Pcs	UM	€
609120052005	5x20	50	PCK	
609120052505	5x25	50	PCK	
609120053005	5x30	50	PCK	
609120053505	5x35	50	PCK	
609120054005	5x40	50	PCK	
609120055005	5x50	50	PCK	
609120056005	5x60	50	PCK	
609120062005	6x20	50	PCK	
609120062505	6x25	50	PCK	
609120063005	6x30	50	PCK	
609120064005	6x40	50	PCK	
609120065005	6x50	50	PCK	
609120066002	6x60	20	PCK	
609120068002	6x80	20	PCK	
609120610001	6x100	10	PCK	
609120082002	8x20	20	PCK	
609120083002	8x30	20	PCK	
609120084002	8x40	20	PCK	
609120085002	8x50	20	PCK	
609120086002	8x60	20	PCK	
609120088001	8x80	10	PCK	
609121010001	10x100	10	PCK	

Pan Head Machine Screws DIN 84

Stainless Steel DIN 84 A2 metric round head machine screws.



Code	mm	Pack / Pcs	UM	€
600840031410	3x14	100	PCK	
600840032010	3x20	100	PCK	
600840032510	3x25	100	PCK	
600840033010	3x30	100	PCK	
600840042010	4x20	100	PCK	
600840042510	4x25	100	PCK	
600840043010	4x30	100	PCK	
600840043510	4x35	100	PCK	
600840044010	4x40	100	PCK	
600840045010	4x50	100	PCK	
600840052010	5x20	100	PCK	
600840052510	5x25	100	PCK	
600840053010	5x30	100	PCK	
600840053505	5x35	50	PCK	
600840054005	5x40	50	PCK	
600840055005	5x50	50	PCK	
600840056005	5x60	50	PCK	
600840062005	6x20	50	PCK	
600840063005	6x30	50	PCK	
600840064005	6x40	50	PCK	
600840065005	6x50	50	PCK	
600840066005	6x60	50	PCK	
600840068002	6x80	20	PCK	
600840610002	6x100	20	PCK	
600840083005	8x30	50	PCK	
600840084005	8x40	50	PCK	
600840085005	8x50	50	PCK	
600840086002	8x60	20	PCK	
600840088002	8x80	20	PCK	
600840810001	8x100	10	PCK	

Slotted Oval Head Machine Screws DIN 964

Stainless Steel DIN 964 A2 metric slotted oval head machine screws.



Code	mm	Pack / Pcs	UM	€
609640031410	3x14	100	PCK	
609640032010	3x20	100	PCK	
609640032510	3x25	100	PCK	
609640033010	3x30	100	PCK	
609640042010	4x20	100	PCK	
609640042510	4x25	100	PCK	
609640043010	4x30	100	PCK	
609640043510	4x35	100	PCK	
609640044010	4x40	100	PCK	
609640045010	4x50	100	PCK	
609640052010	5x20	100	PCK	
609640052510	5x25	100	PCK	
609640053010	5x30	100	PCK	
609640053505	5x35	50	PCK	
609640054005	5x40	50	PCK	
609640055005	5x50	50	PCK	
609640056005	5x60	50	PCK	
609640062005	6x20	50	PCK	
609640063005	6x30	50	PCK	
609640064005	6x40	50	PCK	
609640065005	6x50	50	PCK	
609640066005	6x60	50	PCK	
609640068002	6x80	20	PCK	
609640610002	6x100	20	PCK	
609640083005	8x30	50	PCK	
609640084005	8x40	50	PCK	
609640085005	8x50	50	PCK	
609640086002	8x60	20	PCK	
609640088002	8x80	20	PCK	
609640810001	8x100	10	PCK	

Hex Head Partly Threaded Machine Bolts DIN 931

Stainless Steel DIN 931 A2 metric hex head partly threaded machine screws.



Code	mm	Pack / Pcs	UM	€
609310065002	6x50	20	PCK	
609310066002	6x60	20	PCK	
609310067002	6x70	20	PCK	
609310068002	6x80	20	PCK	
609310610001	6x100	10	PCK	
609310612001	6x120	10	PCK	
609310086001	8x60	10	PCK	
609310087001	8x70	10	PCK	
609310088001	8x80	10	PCK	
609310810001	8x100	10	PCK	
609310812001	8x120	10	PCK	
609310815001	8x150	10	PCK	
609310108001	10x80	10	PCK	
609311010001	10x100	10	PCK	
609311015001	10x150	10	PCK	
609311020001	10x200	10	PCK	
609310128001	12x80	10	PCK	
609311210001	12x100	10	PCK	
609311215001	12x150	10	PCK	
609311220001	12x200	10	PCK	

STAINLESS STEEL A2 FASTENERS

NUTS AND WASHERS

Hex Nuts DIN 934

Stainless Steel DIN 934 A2 hex nuts.



Code	mm	Pack / Pcs	UM	€
620093400310	M3	100	PCK	
620093400410	M4	100	PCK	
620093400510	M5	100	PCK	
620093400610	M6	100	PCK	
620093400810	M8	100	PCK	
620093401005	M10	50	PCK	
620093401205	M12	50	PCK	
620093401402	M14	20	PCK	
620093401602	M16	20	PCK	
620093401801	M18	10	PCK	

Nylock Nuts DIN 985

Stainless Steel DIN 985 A2 nylock nuts.



Code	mm	Pack / Pcs	UM	€
620098500405	M4	50	PCK	
620098500505	M5	50	PCK	
620098500605	M6	50	PCK	
620098500805	M8	50	PCK	
620098501005	M10	50	PCK	
620098501202	M12	20	PCK	
620098501401	M14	10	PCK	

Cap Nuts DIN 1587

Stainless Steel DIN 1587 A2 cap nuts.



Code	mm	Pack / Pcs	UM	€
620158700405	M4	50	PCK	
620158700505	M5	50	PCK	
620158700605	M6	50	PCK	
620158700802	M8	20	PCK	
620158701002	M10	20	PCK	
620158701202	M12	20	PCK	
620158701401	M14	10	PCK	

Wing Nuts DIN 315

Stainless Steel DIN 315 A2 wing nuts.



Code	mm	Pack / Pcs	UM	€
620031500505	M5	50	PCK	
620031500605	M6	50	PCK	
620031500802	M8	20	PCK	
620031501002	M10	20	PCK	
620031501201	M12	10	PCK	

Flat Washers DIN 125

Stainless Steel DIN 125 A2 flat washers.



Code	mm	Pack / Pcs	UM	€
625011250310	D.3	100	PCK	
625011250410	D.4	100	PCK	
625011250510	D.5	100	PCK	
625011250610	D.6	100	PCK	
625011250810	D.8	100	PCK	
625011251010	D.10	100	PCK	
625011251205	D.12	50	PCK	
625011251405	D.14	50	PCK	
625011251602	D.16	20	PCK	
625011251802	D.18	20	PCK	

Fender Washers 3 Times Bigger than Hole

Stainless Steel A2 fender washers 3 times bigger than the hole.



Code	mm	Pack / Pcs	UM	€
625000039010	3x9	100	PCK	
625000103005	10x30	50	PCK	
625000123602	12x36	20	PCK	
625000144202	14x42	20	PCK	
625000041210	4x12	100	PCK	
625000051510	5x15	100	PCK	
625000061810	6x18	100	PCK	
625000082410	8x24	100	PCK	

Lock Washers DIN 127

Stainless Steel DIN 127 A2 lock washers.



Code	mm	Pack / Pcs	UM	€
625011270310	D.3	100	PCK	
625011270410	D.4	100	PCK	
625011270510	D.5	100	PCK	
625011270610	D.6	100	PCK	
625011270810	D.8	100	PCK	
625011271010	D.10	100	PCK	
625011271205	D.12	50	PCK	
625011271405	D.14	50	PCK	
625011271602	D.16	20	PCK	
625011271802	D.18	20	PCK	

1 Meter Threaded Rod DIN 975

Stainless Steel DIN 975 A2 1 meter threaded rods.



Code	mm	UM	€
6300997504	M4	PCS	
6300997505	M5	PCS	
6300997506	M6	PCS	
6300997508	M8	PCS	
6300997510	M10	PCS	
6300997512	M12	PCS	
6300997514	M14	PCS	
6300997516	M16	PCS	
6300997518	M18	PCS	

Cotter Pins DIN 94

Stainless Steel DIN 94 A4 cotter pins.



Code	mm	Pack / Pcs	UM	€
650094152010	1,5x20	100	PCK	
650094152510	1,5x25	100	PCK	
650094022010	2x20	100	PCK	
650094022510	2x25	100	PCK	
650094023010	2x30	100	PCK	
650094252010	2,5x20	100	PCK	
650094252510	2,5x25	100	PCK	
650094253010	2,5x30	100	PCK	
650094253510	2,5x35	100	PCK	
650094032010	3x20	100	PCK	
650094032510	3x25	100	PCK	
650094033010	3x30	100	PCK	
650094033510	3x35	100	PCK	
650094034010	3x40	100	PCK	
650094035010	3x50	100	PCK	
650094043010	4x30	100	PCK	
650094044005	4x40	50	PCK	
650094045005	4x50	50	PCK	
650094054005	5x40	50	PCK	
650094055005	5x50	50	PCK	
650094056005	5x60	50	PCK	
650094065005	6x50	50	PCK	
650094066005	6x60	50	PCK	

Blind Rivets

Stainless Steel A2 blind rivets.



Code	mm	Pack / Pcs	UM	€
6600000326	3,2 x 6	100	PCK	
6600000329	3,2 x 8	100	PCK	
66000003211	3,2 x 10	100	PCK	
66000003212	3,2 x 12	100	PCK	
6600000389	4 x 8	100	PCK	
66000003811	4 x 10	100	PCK	
66000003812	4 x 12	100	PCK	
66000003814	4 x 14	100	PCK	
66000003816	4 x 16	100	PCK	
6600000489	4,8 x 8	100	PCK	
66000004811	4,8 x 10	100	PCK	
66000004812	4,8 x 12	100	PCK	
66000004814	4,8 x 14	100	PCK	
66000004816	4,8 x 16	100	PCK	
66000004818	4,8 x 18	100	PCK	

Flat Head Tapping Screws Phillips DIN 7982

Stainless Steel DIN 7982 A2 flat head tapping screws phillips.



Code	mm	Pack / Pcs	UM	€
607982290910	2,9x9,5	100	PCK	
607982291310	2,9x13	100	PCK	
607982291610	2,9x16	100	PCK	
607982291910	2,9x19	100	PCK	
607982292210	2,9x22	100	PCK	
607982351310	3,5x13	100	PCK	
607982351610	3,5x16	100	PCK	
607982351910	3,5x19	100	PCK	
607982352210	3,5x22	100	PCK	
607982352510	3,5x25	100	PCK	
607982353210	3,5x32	100	PCK	
607982353810	3,5x38	100	PCK	
607982391310	3,9x13	100	PCK	
607982391610	3,9x16	100	PCK	
607982391910	3,9x19	100	PCK	
607982392210	3,9x22	100	PCK	
607982392510	3,9x25	100	PCK	
607982393210	3,9x32	100	PCK	
607982393810	3,9x38	100	PCK	
607982421610	4,2x16	100	PCK	
607982421910	4,2x19	100	PCK	
607982422210	4,2x22	100	PCK	
607982422510	4,2x25	100	PCK	
607982423210	4,2x32	100	PCK	
607982423810	4,2x38	100	PCK	
607982425010	4,2x50	100	PCK	
607982481610	4,8x16	100	PCK	
607982481910	4,8x19	100	PCK	
607982482210	4,8x22	100	PCK	
607982482510	4,8x25	100	PCK	
607982483210	4,8x32	100	PCK	
607982483805	4,8x38	50	PCK	
607982485005	4,8x50	50	PCK	
607982551905	5,5x19	50	PCK	
607982552205	5,5x22	50	PCK	
607982553205	5,5x32	50	PCK	
607982553805	5,5x38	50	PCK	
607982555005	5,5x50	50	PCK	
607982556005	5,5x60	50	PCK	
607982632205	6,3x22	50	PCK	
607982632505	6,3x25	50	PCK	
607982633205	6,3x32	50	PCK	
607982633802	6,3x38	20	PCK	
607982635002	6,3x50	20	PCK	
607982636002	6,3x60	20	PCK	
607982637002	6,3x70	20	PCK	

Oval Head Tapping Screws Phillips DIN 7983

Stainless Steel DIN 7983 A2 oval head tapping screws phillips.



Code	mm	Pack / Pcs	UM	€
607983290910	2,9x9,5	100	PCK	
607983291310	2,9x13	100	PCK	
607983291610	2,9x16	100	PCK	
607983291910	2,9x19	100	PCK	
607983292210	2,9x22	100	PCK	
607983351310	3,5x13	100	PCK	
607983351610	3,5x16	100	PCK	
607983351910	3,5x19	100	PCK	
607983352210	3,5x22	100	PCK	
607983352510	3,5x25	100	PCK	
607983353210	3,5x32	100	PCK	
607983353810	3,5x38	100	PCK	
607983391310	3,9x13	100	PCK	
607983391610	3,9x16	100	PCK	
607983391910	3,9x19	100	PCK	
607983392210	3,9x22	100	PCK	
607983392510	3,9x25	100	PCK	
607983393210	3,9x32	100	PCK	
607983393810	3,9x38	100	PCK	
607983421610	4,2x16	100	PCK	
607983421910	4,2x19	100	PCK	
607983422210	4,2x22	100	PCK	
607983422510	4,2x25	100	PCK	
607983423210	4,2x32	100	PCK	
607983423810	4,2x38	100	PCK	
607983425010	4,2x50	100	PCK	
607983481610	4,8x16	100	PCK	
607983481910	4,8x19	100	PCK	
607983482210	4,8x22	100	PCK	
607983482510	4,8x25	100	PCK	
607983483210	4,8x32	100	PCK	
607983483805	4,8x38	50	PCK	
607983485005	4,8x50	50	PCK	
607983551905	5,5x19	50	PCK	
607983552205	5,5x22	50	PCK	
607983553205	5,5x32	50	PCK	
607983553805	5,5x38	50	PCK	
607983555005	5,5x50	50	PCK	
607983556005	5,5x60	50	PCK	
607983632205	6,3x22	50	PCK	
607983632505	6,3x25	50	PCK	
607983633205	6,3x32	50	PCK	
607983633802	6,3x38	20	PCK	
607983635002	6,3x50	20	PCK	
607983636002	6,3x60	20	PCK	
607983637002	6,3x70	20	PCK	

Pan Head Tapping Screw Phillips DIN 7981

Stainless Steel DIN 7981 A2 pan head tapping screws phillips.



Code	mm	Pack / Pcs	UM	€
607981290910	2,9x9,5	100	PCK	
607981291310	2,9x13	100	PCK	
607981291610	2,9x16	100	PCK	
607981291910	2,9x19	100	PCK	
607981292210	2,9x22	100	PCK	
607981351310	3,5x13	100	PCK	
607981351610	3,5x16	100	PCK	
607981351910	3,5x19	100	PCK	
607981352210	3,5x22	100	PCK	
607981352510	3,5x25	100	PCK	
607981353210	3,5x32	100	PCK	
607981353810	3,5x38	100	PCK	
607981391310	3,9x13	100	PCK	
607981391610	3,9x16	100	PCK	
607981391910	3,9x19	100	PCK	
607981392210	3,9x22	100	PCK	
607981392510	3,9x25	100	PCK	
607981393210	3,9x32	100	PCK	
607981393810	3,9x38	100	PCK	
607981421610	4,2x16	100	PCK	
607981421910	4,2x19	100	PCK	
607981422210	4,2x22	100	PCK	
607981422510	4,2x25	100	PCK	
607981423210	4,2x32	100	PCK	
607981423810	4,2x38	100	PCK	
607981425010	4,2x50	100	PCK	
607981481610	4,8x16	100	PCK	
607981481910	4,8x19	100	PCK	
607981482210	4,8x22	100	PCK	
607981482510	4,8x25	100	PCK	
607981483210	4,8x32	100	PCK	
607981483805	4,8x38	50	PCK	
607981485005	4,8x50	50	PCK	
607981551905	5,5x19	50	PCK	
607981552205	5,5x22	50	PCK	
607981553205	5,5x32	50	PCK	
607981553805	5,5x38	50	PCK	
607981555005	5,5x50	50	PCK	
607981556005	5,5x60	50	PCK	
607981632205	6,3x22	50	PCK	
607981632505	6,3x25	50	PCK	
607981633205	6,3x32	50	PCK	
607981633802	6,3x38	20	PCK	
607981635002	6,3x50	20	PCK	
607981636002	6,3x60	20	PCK	
607981637002	6,3x70	20	PCK	

- WOOD SCREWS -**Slotted Flat Head Chipboard Screws DIN 6112**

Stainless Steel DIN 6112 A2 slotted flat head chipboard and wood screws.

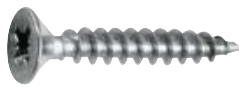

Code	mm	Pack / Pcs	UM	€
606112301210	3x12	100	PCK	
606112301610	3x16	100	PCK	
606112302010	3x20	100	PCK	
606112302510	3x25	100	PCK	
606112303010	3x30	100	PCK	
606112303510	3x35	100	PCK	
606112351610	3,5x16	100	PCK	
606112352010	3,5x20	100	PCK	
606112352510	3,5x25	100	PCK	
606112353010	3,5x30	100	PCK	
606112353510	3,5x35	100	PCK	
606112354010	3,5x40	100	PCK	
606112402010	4x20	100	PCK	
606112402510	4x25	100	PCK	
606112403010	4x30	100	PCK	
606112403510	4x35	100	PCK	

Code	mm	Pack / Pcs	UM	€
606112404010	4x40	100	PCK	
606112404510	4x45	100	PCK	
606112405010	4x50	100	PCK	
606112453010	4,5x30	100	PCK	
606112453510	4,5x35	100	PCK	
606112454010	4,5x40	100	PCK	
606112454510	4,5x45	100	PCK	
606112455010	4,5x50	100	PCK	
606112503010	5x30	100	PCK	
606112504010	5x40	100	PCK	
606112504505	5x45	50	PCK	
606112505005	5x50	50	PCK	
606112506005	5x60	50	PCK	
606112507005	5x70	50	PCK	
606112508005	5x80	50	PCK	
606112604005	6x40	50	PCK	
606112605005	6x50	50	PCK	
606112606005	6x60	50	PCK	
606112607002	6x70	20	PCK	
606112608002	6x80	20	PCK	
606112609002	6x90	20	PCK	
606112601002	6x100	20	PCK	

Hex Head Lag Screws DIN 571

Stainless Steel DIN 571 A2 hex head lag screws.



Code	mm	Pack / Pcs	UM	€
615710063002	6x30	20	PCK	
615710064002	6x40	20	PCK	
615710065002	6x50	20	PCK	
615710066002	6x60	20	PCK	
615710068002	6x80	20	PCK	
615710084002	8x40	20	PCK	
615710085002	8x50	20	PCK	
615710086002	8x60	20	PCK	
615710088002	8x80	20	PCK	
615710810001	8x100	10	PCK	
615710812001	8x120	10	PCK	
615710105002	10x50	20	PCK	
615710106002	10x60	20	PCK	
615710108002	10x80	20	PCK	
615710100001	10x100	10	PCK	

Hex Head Machine Screws DIN 933

Stainless Steel DIN 933 A4 metric hex head machine screws.



Code	mm	Pack / Pcs	UM	€
709330052010	5x20	100	PCK	
709330053010	5x30	100	PCK	
709330054005	5x40	50	PCK	
709330055005	5x50	50	PCK	
709330062005	6x20	50	PCK	
709330063005	6x30	50	PCK	
709330064005	6x40	50	PCK	
709330065005	6x50	50	PCK	
709330066005	6x60	50	PCK	
709330068002	6x80	20	PCK	
709330610002	6x100	20	PCK	
709330083005	8x30	50	PCK	
709330084005	8x40	50	PCK	
709330085005	8x50	50	PCK	
709330086002	8x60	20	PCK	
709330088002	8x80	20	PCK	
709330810001	8x100	10	PCK	
709330104002	10x40	20	PCK	
709330105002	10x50	20	PCK	
709330106002	10x60	20	PCK	
709330108002	10x80	20	PCK	
709331010001	10x100	10	PCK	

Slotted Flat Head Machine Screws DIN 963

Stainless Steel DIN 963 A4 metric slotted head machine screws.



Code	mm	Pack / Pcs	UM	€
709630032010	3x20	100	PCK	
709630032510	3x25	100	PCK	
709630033010	3x30	100	PCK	
709630042010	4x20	100	PCK	
709630042510	4x25	100	PCK	
709630043010	4x30	100	PCK	
709630044010	4x40	100	PCK	
709630045010	4x50	100	PCK	
709630052010	5x20	100	PCK	
709630053010	5x30	100	PCK	
709630054005	5x40	50	PCK	
709630055005	5x50	50	PCK	
709630056005	5x60	50	PCK	
709630063005	6x30	50	PCK	
709630064005	6x40	50	PCK	
709630065005	6x50	50	PCK	
709630066005	6x60	50	PCK	
709630068002	6x80	20	PCK	
709630610002	6x100	20	PCK	
709630083005	8x30	50	PCK	
709630084005	8x40	50	PCK	
709630085005	8x50	50	PCK	
709630086002	8x60	20	PCK	
709630088002	8x80	20	PCK	
709630810001	8x100	10	PCK	

- NUTS AND WASHERS -

Hex Nuts DIN 934

Stainless Steel DIN 934 A4 hex nuts.



Code	mm	Pack / Pcs	UM	€
720093400410	M4	100	PCK	
720093400510	M5	100	PCK	
720093400610	M6	100	PCK	
720093400810	M8	100	PCK	
720093401005	M10	50	PCK	

Nylock Nuts DIN 985

Stainless Steel DIN 985 A4 nylock nuts.



Code	mm	Pack / Pcs	UM	€
720098500405	M4	50	PCK	
720098500505	M5	50	PCK	
720098500605	M6	50	PCK	
720098500805	M8	50	PCK	
720098501005	M10	50	PCK	

- TAPPING SCREW PHILLIPS -

Flat Head Tapping Screws Phillips DIN 7982

Stainless Steel DIN 7982 A4 flat head tapping screws phillips.



Code	mm	Pack / Pcs	UM	€
707982351310	3,5x13	100	PCK	
707982351610	3,5x16	100	PCK	
707982351910	3,5x19	100	PCK	
707982352210	3,5x22	100	PCK	
707982352510	3,5x25	100	PCK	
707982391310	3,9x13	100	PCK	
707982391610	3,9x16	100	PCK	
707982391910	3,9x19	100	PCK	
707982392210	3,9x22	100	PCK	
707982392510	3,9x25	100	PCK	
707982393210	3,9x32	100	PCK	
707982393810	3,9x38	100	PCK	
707982421610	4,2x16	100	PCK	
707982421910	4,2x19	100	PCK	
707982422210	4,2x22	100	PCK	
707982422510	4,2x25	100	PCK	
707982423210	4,2x32	100	PCK	
707982423810	4,2x38	100	PCK	
707982481610	4,8x16	100	PCK	
707982481910	4,8x19	100	PCK	
707982482210	4,8x22	100	PCK	
707982482510	4,8x25	100	PCK	
707982483210	4,8x32	100	PCK	
707982483805	4,8x38	50	PCK	
707982485005	4,8x50	50	PCK	
707982552205	5,5x22	50	PCK	
707982553205	5,5x32	50	PCK	
707982553805	5,5x38	50	PCK	
707982555005	5,5x50	50	PCK	
707982632505	6,3x25	50	PCK	
707982633205	6,3x32	50	PCK	
707982633802	6,3x38	20	PCK	
707982635002	6,3x50	20	PCK	
707982636002	6,3x60	20	PCK	

Pan Head Tapping Screw Phillips DIN 7981

Stainless Steel DIN 7981 A4 pan head tapping screws phillips.



Code	mm	Pack / Pcs	UM	€
707981351310	3,5x13	100	PCK	
707981351610	3,5x16	100	PCK	
707981351910	3,5x19	100	PCK	
707981352210	3,5x22	100	PCK	
707981352510	3,5x25	100	PCK	
707981391310	3,9x13	100	PCK	
707981391610	3,9x16	100	PCK	
707981391910	3,9x19	100	PCK	
707981392210	3,9x22	100	PCK	
707981392510	3,9x25	100	PCK	
707981393210	3,9x32	100	PCK	
707981393810	3,9x38	100	PCK	
707981421610	4,2x16	100	PCK	
707981421910	4,2x19	100	PCK	
707981422210	4,2x22	100	PCK	
707981422510	4,2x25	100	PCK	
707981423210	4,2x32	100	PCK	
707981423810	4,2x38	100	PCK	
707981481610	4,8x16	100	PCK	
707981481910	4,8x19	100	PCK	
707981482210	4,8x22	100	PCK	
707981482510	4,8x25	100	PCK	
707981483210	4,8x32	100	PCK	
707981483805	4,8x38	50	PCK	
707981485005	4,8x50	50	PCK	
707981552205	5,5x22	50	PCK	
707981553205	5,5x32	50	PCK	
707981553805	5,5x38	50	PCK	
707981555005	5,5x50	50	PCK	
707981632505	6,3x25	50	PCK	
707981633205	6,3x32	50	PCK	
707981633802	6,3x38	20	PCK	
707981635002	6,3x50	20	PCK	
707981636002	6,3x60	20	PCK	

Flat Washers DIN 125

Stainless Steel DIN 125 A4 flat washers.



Code	mm	Pack / Pcs	UM	€
725011250410	D.4	100	PCK	
725011250510	D.5	100	PCK	
725011250610	D.6	100	PCK	
725011250810	D.8	100	PCK	
725011251010	D.10	100	PCK	

Fender Washers 3 Times Bigger than Hole

Stainless Steel A4 fender washers 3 times bigger than the hole.



Code	mm	Pack / Pcs	UM	€
725000041210	4x12	100	PCK	
725000051510	5x15	100	PCK	
725000061810	6x18	100	PCK	
725000082410	8x24	100	PCK	
725000103005	10x30	50	PCK	

Slotted Flat Head Machine Screws DIN 965

Stainless Steel DIN 965 A4 metric slotted head machine screw. In handy and elegant blister pack complete of nuts.



Code	mm	Pack / Pcs	UM	€
796504020	4x20	8	PCK	
796504025	4x25	6	PCK	
796504030	4x30	6	PCK	
796504040	4x40	6	PCK	
796504050	4x50	4	PCK	
796505020	5x20	6	PCK	
796505025	5x25	6	PCK	
796505030	5x30	6	PCK	
796505040	5x40	6	PCK	
796505050	5x50	4	PCK	
796505060	5x60	4	PCK	
796506020	6x20	4	PCK	
796506025	6x25	4	PCK	
796506030	6x30	4	PCK	
796506040	6x40	4	PCK	
796506050	6x50	4	PCK	
796506060	6x60	4	PCK	
796506070	6x70	4	PCK	
796506090	6x90	2	PCK	
796508030	8x30	4	PCK	
796508040	8x40	4	PCK	
796508050	8x50	2	PCK	
796508060	8x60	2	PCK	
796508080	8x80	2	PCK	

Pan Head Machine Screws DIN 7985

Stainless Steel DIN 7985 A4 metric round head machine screws. In handy and elegant blister pack complete of nuts.



Code	mm	Pack / Pcs	UM	€
798504020	4x20	8	PCK	
798504025	4x25	6	PCK	
798504030	4x30	6	PCK	
798504040	4x40	6	PCK	
798504050	4x50	6	PCK	
798505020	5x20	6	PCK	
798505030	5x30	6	PCK	
798505040	5x40	4	PCK	
798505050	5x50	4	PCK	
798506020	6x20	4	PCK	
798506025	6x25	4	PCK	
798506040	6x40	4	PCK	
798506050	6x50	4	PCK	
798506060	6x60	4	PCK	

Hex Nuts DIN 934

Stainless Steel DIN 934 A4 hex nuts. In handy and elegant blister packs.



Code	mm	Pack / Pcs	UM	€
7934004	M4	15	PCK	
7934005	M5	15	PCK	
7934006	M6	10	PCK	
7934008	M8	5	PCK	
7934010	M10	4	PCK	

Hex Nylock Nuts DIN 985

Stainless Steel DIN 985 A4 nylock hex nuts. In handy and elegant blister packs.



Code	mm	Pack / Pcs	UM	€
7985004	M4	6	PCK	
7985005	M5	6	PCK	
7985006	M6	4	PCK	
7985008	M8	4	PCK	
7985010	M10	2	PCK	

Hex Head Machine Screws DIN 933

Stainless Steel DIN 933 A4 metric hex head machine screw. In handy and elegant blisters pack complete of nuts.



Code	mm	Pack / Pcs	UM	€
793305020	5x20	8	PCK	
793305025	5x25	6	PCK	
793305030	5x30	6	PCK	
793305040	5x40	6	PCK	
793305050	5x50	4	PCK	
793305060	5x60	4	PCK	
793306020	6x20	6	PCK	
793306025	6x25	6	PCK	
793306030	6x30	4	PCK	
793306040	6x40	4	PCK	
793306050	6x50	4	PCK	
793306060	6x60	4	PCK	
793306080	6x80	2	PCK	
793306100	6x100	2	PCK	
793308030	8x30	4	PCK	
793308040	8x40	4	PCK	
793308050	8x50	2	PCK	
793308060	8x60	2	PCK	
793308080	8x80	2	PCK	
793308100	8x100	2	PCK	
793310030	10x30	2	PCK	
793310040	10x40	2	PCK	
793310050	10x50	2	PCK	
793310060	10x60	2	PCK	
793310080	10x80	1	PCK	
793310100	10x100	1	PCK	

Hex Hollow Screws DIN 912

Stainless Steel DIN 912 A4 hexagonal hollow partly threaded screws. In handy and elegant blister pack



complete of nuts.

Code	mm	Pack / Pcs	UM	€
791205020	5x20	6	PCK	
791205025	5x25	6	PCK	
791205030	5x30	6	PCK	
791205040	5x40	6	PCK	
791205050	5x50	4	PCK	
791205060	5x60	4	PCK	
791206020	6x20	4	PCK	
791206025	6x25	4	PCK	
791206030	6x30	4	PCK	
791206040	6x40	4	PCK	
791206050	6x50	4	PCK	
791206060	6x60	4	PCK	
791208030	8x30	2	PCK	
791208040	8x40	2	PCK	
791208050	8x50	2	PCK	
791208060	8x60	2	PCK	
791208080	8x80	2	PCK	
791208100	8x100	2	PCK	

Flat Washers DIN 125

Stainless Steel DIN 125 A4 flat washers. In handy and elegant blister packs.



Code	mm	Pack / Pcs	UM	€
7125004	D.4	20	PCK	
7125005	D.5	20	PCK	
7125006	D.6	20	PCK	
7125008	D.8	20	PCK	
7125010	D.10	10	PCK	

Fender Washers 3 Times Bigger than Hole DIN 9021

Stainless Steel DIN 9021 A4 fender washers 3 times bigger than the hole. In handy and elegant blister packs.

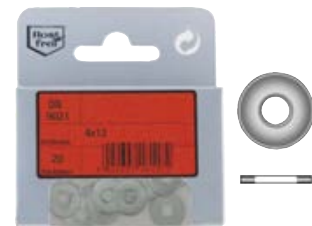

Code	mm	Pack / Pcs	UM	€
7902104	4x12	20	PCK	
7902105	5x15	20	PCK	
7902106	6x18	20	PCK	
7902108	8x24	10	PCK	
7902110	10x30	4	PCK	

Pan Head Self-Tapping Screws DIN 7981

Stainless Steel DIN 7981 A4 pan head self-tapping screws. Sold in handy and elegant blister packs.



Code	mm	Pack / Pcs	UM	€
798129009	2,9x9,5	20	PCK	
798129013	2,9x13	20	PCK	
798129016	2,9x16	20	PCK	
798129019	2,9x19	20	PCK	
798135013	3,5x13	15	PCK	
798135016	3,5x16	12	PCK	
798135019	3,5x19	12	PCK	
798135025	3,5x25	12	PCK	
798139016	3,9x16	12	PCK	
798139019	3,9x19	12	PCK	
798139025	3,9x25	12	PCK	
798139032	3,9x32	10	PCK	
798139038	3,9x38	10	PCK	
798142016	4,2x16	12	PCK	
798142019	4,2x19	12	PCK	
798142025	4,2x25	10	PCK	
798142032	4,2x32	10	PCK	
798142038	4,2x38	6	PCK	
798148016	4,8x16	10	PCK	
798148019	4,8x19	10	PCK	
798148025	4,8x25	10	PCK	
798148032	4,8x32	6	PCK	
798148038	4,8x38	6	PCK	
798155019	5,5x19	6	PCK	
798155025	5,5x25	6	PCK	
798155032	5,5x32	6	PCK	
798155038	5,5x38	6	PCK	
798155050	5,5x50	4	PCK	
798163019	6,3x19	6	PCK	
798163025	6,3x25	6	PCK	
798163032	6,3x32	6	PCK	
798163038	6,3x38	6	PCK	
798163050	6,3x50	4	PCK	

Hex Head Wood Screws DIN 571

Stainless Steel DIN 571 A2 hex head wood screws in handy and elegant blister pack.



Code	mm	Pack / Pcs	UM	€
75716030	6x30	4	PCK	
75716040	6x40	4	PCK	
75716050	6x50	4	PCK	
75716060	6x60	4	PCK	
75718040	8x40	4	PCK	
75718060	8x60	2	PCK	
75718080	8x80	2	PCK	
75718100	8x100	2	PCK	

Slotted Flat Head Self-Tapping Screws DIN 7982

Stainless Steel DIN 7982 A4 slotted flat head self-tapping screws. In handy and elegant blister packs.



Code	mm	Pack / Pcs	UM	€
798229009	2,9x9,5	20	PCK	
798229013	2,9x13	20	PCK	
798229016	2,9x16	20	PCK	
798229019	2,9x19	20	PCK	
798235013	3,5x13	15	PCK	
798235016	3,5x16	12	PCK	
798235019	3,5x19	12	PCK	
798235025	3,5x25	12	PCK	
798239019	3,9x19	12	PCK	
798239025	3,9x25	12	PCK	
798239032	3,9x32	10	PCK	
798239038	3,9x38	10	PCK	
798242016	4,2x16	12	PCK	
798242019	4,2x19	12	PCK	
798242025	4,2x25	10	PCK	
798242032	4,2x32	10	PCK	
798242038	4,2x38	6	PCK	
798248016	4,8x16	10	PCK	
798248019	4,8x19	10	PCK	
798248025	4,8x25	10	PCK	
798248032	4,8x32	6	PCK	
798248038	4,8x38	6	PCK	
798255019	5,5x19	6	PCK	
798255025	5,5x25	6	PCK	
798255032	5,5x32	6	PCK	
798255038	5,5x38	6	PCK	
798255045	5,5x45	6	PCK	
798263025	6,3x25	6	PCK	
798263032	6,3x32	6	PCK	
798263038	6,3x38	6	PCK	
798263050	6,3x50	6	PCK	

Slotted Head Tapping Screws with Cap DIN 7983

Stainless Steel DIN 7983 A4 slotted head self-tapping screws with cap. In handy and elegant blister packs.



Code	mm	Pack / Pcs	UM	€
798329009	2,9x9,5	20	PCK	
798329013	2,9x13	20	PCK	
798329016	2,9x16	20	PCK	
798329019	2,9x19	15	PCK	
798335013	3,5x13	15	PCK	
798335016	3,5x16	12	PCK	
798335019	3,5x19	12	PCK	
798335025	3,5x25	12	PCK	
798339016	3,9x16	12	PCK	
798339019	3,9x19	12	PCK	
798339025	3,9x25	12	PCK	
798342016	4,2x16	12	PCK	
798342019	4,2x19	12	PCK	
798342025	4,2x25	10	PCK	
798342032	4,2x32	10	PCK	
798342038	4,2x38	6	PCK	
798348016	4,8x16	10	PCK	
798348019	4,8x19	10	PCK	
798348025	4,8x25	10	PCK	
798348032	4,8x32	6	PCK	
798348038	4,8x38	6	PCK	
798355019	5,5x19	6	PCK	
798355025	5,5x25	6	PCK	
798355032	5,5x32	6	PCK	
798355038	5,5x38	6	PCK	
798355050	5,5x50	4	PCK	
798363019	6,3x19	6	PCK	
798363025	6,3x25	6	PCK	
798363038	6,3x38	6	PCK	
798363050	6,3x50	4	PCK	

Slotted Flat Head Chipboard and Wood Screws DIN 6112

Stainless Steel DIN 6112 A4 slotted flat head chipboard and wood screws. In handy and elegant blister packs.



Code	mm	Pack / Pcs	UM	€
761123016	3x16	10	PCK	
761123020	3x20	10	PCK	
761123025	3x25	8	PCK	
761123030	3x30	8	PCK	
761123516	3,5x16	8	PCK	
761123520	3,5x20	8	PCK	
761123530	3,5x30	8	PCK	
761123540	3,5x40	8	PCK	
761124020	4x20	8	PCK	
761124030	4x30	8	PCK	
761124040	4x40	6	PCK	
761124050	4x50	4	PCK	
761125030	5x30	4	PCK	
761125040	5x40	4	PCK	
761125050	5x50	4	PCK	
761125060	5x60	2	PCK	
761126040	6x40	2	PCK	
761126050	6x50	2	PCK	
761126060	6x60	2	PCK	
761126080	6x80	2	PCK	