

2

ŽELJEZARIJA /
BRAVE /
VIJCI



MTM

Ravni Škopac

Ravni škopac od Inoxa AISI 316.

Kod	D mm	L mm	W mm	MJ	€
0120004	4	16	8	KOM	
0120005	5	20	10	KOM	
0120006	6	24	12	KOM	
0120008	8	32	16	KOM	
0120010	10	40	20	KOM	
0120012	12	48	24	KOM	
0120014	14	56	28	KOM	
0120016	16	64	32	KOM	

**Ravni Škopac s Neispadajućom Osovinom**

Ravni škopac od Inoxa AISI 316 s neispadajućom osovinom.

Kod	D mm	L mm	W mm	MJ	€
0120104	4	16	8	KOM	
0120105	5	20	10	KOM	
0120106	6	24	12	KOM	
0120108	8	32	16	KOM	
0120110	10	40	20	KOM	

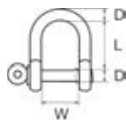
**Škopac Omega**

Škopac Omega od Inoxa AISI 316.

Kod	D mm	L mm	W mm	MJ	€
0120505	5	25	10	KOM	
0120506	6	30	12	KOM	
0120508	8	40	16	KOM	
0120510	10	50	20	KOM	
0120512	12	60	24	KOM	
0120514	14	70	28	KOM	
0120516	16	80	32	KOM	

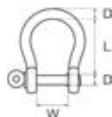
**Škopac Omega s Neispadajućom Osovinom**

Škopac Omega od Inoxa AISI 316 s neispadajućom osovinom.

Kod	D mm	L mm	W mm	MJ	€
0120545	5	25	10	KOM	
0120546	6	30	12	KOM	
0120548	8	40	16	KOM	
0120550	10	50	20	KOM	

**Dugi Škopac**

Dugi škopac od Inoxa AISI 316.

Kod	D mm	L mm	W mm	MJ	€
0120804	4	32	8	KOM	
0120805	5	40	10	KOM	
0120806	6	48	12	KOM	
0120808	8	64	16	KOM	
0120810	10	80	20	KOM	

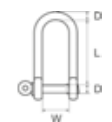
**Dugi Škopac s Neispadajućom Osovinom**

Dugi škopac od Inoxa AISI 316 s neispadajućom osovinom.

Kod	D mm	L mm	W mm	MJ	€
0120704	4	32	8	KOM	
0120705	5	40	10	KOM	
0120706	6	48	12	KOM	
0120708	8	64	16	KOM	

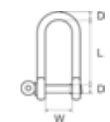
**Široki Škopac**

Široki škopac od Inoxa AISI 316.

Kod	D mm	L mm	W mm	MJ	€
0121106	6	36	24	KOM	
0121108	8	36	28	KOM	
0121110	10	60	40	KOM	
0121112	12	72	48	KOM	

**Uvrnuti Škopac**

Uvrnuti škopac od Inoxa AISI 316.

Kod	D mm	L mm	W mm	MJ	€
0121005	5	30	10	KOM	
0121006	6	36	12	KOM	
0121008	8	40	16	KOM	
0121010	10	50	20	KOM	

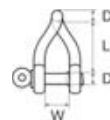
**Dugi Škopac Key Pin**

Dugi škopac s okidnim mehanizmom od Inoxa AISI 316 i neispadajućom osovinom.

Kod	D mm	L mm	W mm	MJ	€
0120905	5	40	13	KOM	
0120906	6	45	16	KOM	
0120908	8	64	22	KOM	

**Dugi Škopac Key Pin B**

Dugi škopac od Inoxa AISI 316 s okidnim mehanizmom, neispadajućom osovinom i šipkom.

Kod	D mm	L mm	W mm	MJ	€
0120915	5	40	13	KOM	
0120916	6	45	16	KOM	
0120918	8	64	22	KOM	



Ravni Škopac Wichard

Ravni škopac Wichard od Inoxa AISI 316 sa samoblokirajućom osovinom. Prekidno opterećenje (BL) testirano i zajamčeno.

Kod	D mm	L mm	W mm	BL Kg	MJ	€
3521004	4	13	8	700	KOM	
3521005	5	16	10	1000	KOM	
3521006	6	20	12	1600	KOM	
3521008	8	26	16	2700	KOM	
3521010	10	33	20	4300	KOM	
3521012	12	39	24	6000	KOM	

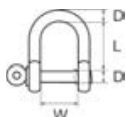
**Ravni Škopac Wichard s Neispadajućom Osovinom**

Standardni škopac Wichard od Inoxa AISI 316 sa samoblokirajućom neispadajućom osovinom. Prekidno opterećenje (BL) testirano i zajamčeno.

Kod	D mm	L mm	W mm	BL Kg	MJ	€
3521024	4	13	8	1000	KOM	
3521025	5	16	10	1500	KOM	
3521026	6	20	12	2200	KOM	
3521028	8	26	16	3600	KOM	
3521030	10	33	20	5200	KOM	

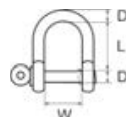
**Škopac Omega Wichard**

Škopac Omega Wichard od Inoxa AISI 316 sa samoblokirajućom osovinom. Prekidno opterećenje (BL) testirano i zajamčeno.

Kod	D mm	L mm	W mm	BL Kg	MJ	€
3521204	4	18	8	700	KOM	
3521205	5	23	10	1000	KOM	
3521206	6	28	12	1600	KOM	
3521208	8	37	16	2700	KOM	
3521210	10	47	20	4300	KOM	
3521212	12	55	24	6000	KOM	

**Škopac Omega Wichard s Neispadajućom Osovinom**

Škopac Omega Wichard od Inoxa AISI 316 sa samoblokirajućom neispadajućom osovinom. Prekidno opterećenje (BL) testirano i zajamčeno.

Kod	D mm	L mm	W mm	BL Kg	MJ	€
3521224	4	18	8	1000	KOM	
3521225	5	23	10	1500	KOM	
3521226	6	28	12	2200	KOM	
3521228	8	37	16	3700	KOM	
3521230	10	47	20	5200	KOM	

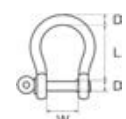
**Dugi Škopac Wichard**

Dugi škopac Wichard od Inoxa AISI 316 sa samoblokirajućom osovinom. Prekidno opterećenje (BL) testirano i zajamčeno.

Kod	D mm	L mm	W mm	BL Kg	MJ	€
3521104	4	22	8	700	KOM	
3521105	5	29	10	1000	KOM	
3521106	6	33	12	1600	KOM	
3521108	8	45	16	2700	KOM	
3521110	10	55	20	4300	KOM	

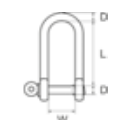
**Dugi Škopac Wichard s Neispadajućom Osovinom**

Dugi škopac Wichard od Inoxa AISI 316 sa samoblokirajućom neispadajućom osovinom. Prekidno opterećenje (BL) testirano i zajamčeno.

Kod	D mm	L mm	W mm	BL Kg	MJ	€
3521124	4	31	8	1000	KOM	
3521125	5	39	10	1500	KOM	
3521126	6	46	12	2200	KOM	
3521128	8	62	16	3600	KOM	

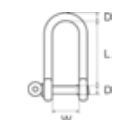
**Uvrnuti Škopac Wichard**

Uvrnuti škopac Wichard od Inoxa AISI 316 sa samoblokirajućom osovinom. Prekidno opterećenje (BL) testirano i zajamčeno.

Kod	D mm	L mm	W mm	BL Kg	MJ	€
3521305	5	26	10	1100	KOM	
3521306	6	30	12	1500	KOM	
3521308	8	40	16	3000	KOM	

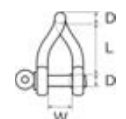
**Uvrnuti Škopac Wichard s Neispadajućom Osovinom**

Uvrnuti škopac Wichard od Inoxa AISI 316 sa samoblokirajućom neispadajućom osovinom. Prekidno opterećenje (BL) testirano i zajamčeno.

Kod	D mm	L mm	W mm	BL Kg	MJ	€
3521325	5	38	10	1500	KOM	
3521326	6	44	12	2100	KOM	
3521328	8	59	16	3700	KOM	

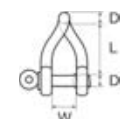

Ravni Škopac MTM

Visokokvalitetni Ravni Škopac od Inoxa 316 na prezentacijskom kartončiću. Radno opterećenje (WL) testirano i zajamčeno. Prekidno opterećenje (BL) je 4 puta veće od radnog opterećenja.

Kod	D mm	L mm	W mm	WL Kg	BL kg	MJ	€
0120005C	5	20	10	230	920	KOM	
0120006C	6	24	12	330	1320	KOM	
0120008C	8	32	16	600	2400	KOM	
0120010C	10	40	20	930	3720	KOM	
0120012C	12	48	24	1400	5600	KOM	
0120014C	14	56	28	1800	7200	KOM	

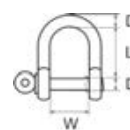

MTM

Škopac Omega MTM

Visokokvalitetni Škopac Omega od Inoxa 316 na prezentacijskom kartončiću. Radno opterećenje (WL) testirano i zajamčeno. Prekidno opterećenje (BL) je 4 puta veće od radnog opterećenja.

Kod	D mm	L mm	W mm	WL Kg	BL Kg	MJ	€
0120506C	6	21	12	330	1320	KOM	
0120508C	8	27	16	590	2370	KOM	
0120510C	10	33	20	930	3720	KOM	
0120512C	12	40	23	1370	5490	KOM	
0120514C	14	51	27	1800	7200	KOM	
0120516C	16	60	32	2440	9760	KOM	

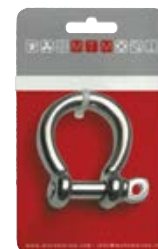
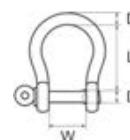

MTM

Dugi Škopac MTM

Visokokvalitetni Dugi Škopac od Inoxa 316 na prezentacijskom kartončiću. Radno opterećenje (WL) testirano i zajamčeno. Prekidno opterećenje (BL) je 4 puta veće od radnog opterećenja.

Kod	D mm	L mm	W mm	WL Kg	BL Kg	MJ	€
0120805C	5	40	10	230	920	KOM	
0120806C	6	48	12	330	1320	KOM	
0120808C	8	64	16	600	2400	KOM	
0120810C	10	80	20	930	3720	KOM	



MTM

Uvrnuti Škopac MTM

Visokokvalitetni Uvrnuti Škopac od Inoxa 316 na prezentacijskom kartončiću. Radno opterećenje (WL) testirano i zajamčeno. Prekidno opterećenje (BL) je 4 puta veće od radnog opterećenja.

Kod	D mm	L mm	W mm	WL Kg	BL Kg	MJ	€
0121005C	5	30	10	230	920	KOM	
0121006C	6	36	12	330	1320	KOM	
0121008C	8	40	16	600	2400	KOM	
0121010C	10	50	20	930	3720	KOM	

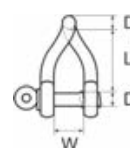

MTM

Široki Škopac MTM

Visokokvalitetni Široki Škopac od Inoxa 316 na prezentacijskom kartončiću. Radno opterećenje (WL) testirano i zajamčeno. Prekidno opterećenje (BL) je 4 puta veće od radnog opterećenja.

Kod	D mm	L mm	W mm	WL Kg	BL Kg	MJ	€
0121106C	6	36	24	330	1320	KOM	
0121108C	8	36	28	600	2400	KOM	
0121110C	10	60	40	930	3720	KOM	
0121112C	12	72	48	1400	5600	KOM	

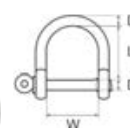

MTM

Dugi Škopac Key Pin MTM

Dugi škopac od Inoxa 316 s okidnim mehanizmom i neispadajućom osovinom na prezentacijskom kartončiću. Radno opterećenje (WL) testirano i zajamčeno. Prekidno opterećenje (BL) je 4 puta veće od radnog opterećenja.

Kod	D mm	L mm	W mm	WL Kg	BL Kg	MJ	€
0120905C	5	40	13	230	920	KOM	
0120906C	6	45	16	330	1320	KOM	
0120908C	8	64	22	600	2400	KOM	

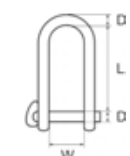

MTM

Dugi Škopac Key Pin B MTM

Visokokvalitetni dugi škopac od Inoxa 316 s okidnim mehanizmom, neispadajućom osovinom i polugom na prezentacijskom kartončiću. Radno opterećenje (WL) testirano i zajamčeno. Prekidno opterećenje (BL) je 4 puta veće od radnog opterećenja.

Kod	D mm	L mm	W mm	WL Kg	BL Kg	MJ	€
0120915C	5	40	13	230	920	KOM	
0120916C	6	45	16	330	1320	KOM	
0120918C	8	64	22	600	2400	KOM	

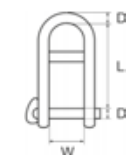

MTM

Ravni Škopac

Ravni škopac od štančanog Inoxa AISI 316.

Kod	D mm	L mm	W mm	MJ	€
0121515	4	15	10	KOM	
0121517	5	17	12	KOM	
0121524	4	20	10	KOM	
0121525	5	24	16	KOM	
0121542	6	23	16	KOM	

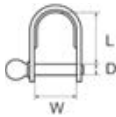
**Dugi Škopac**

Ravni škopac od štančanog Inoxa AISI 316.

Kod	D mm	L mm	W mm	MJ	€
0121540	5	36	16	KOM	
0121543	6	40	14	KOM	
0121544	8	42	18	KOM	

**Ravni Škopac s Prestenom**

Ravni škopac od štančanog Inoxa AISI 316 s prstenom.

Kod	D mm	L mm	W mm	MJ	€
0121502	4	15	10	KOM	
0121503	4	24	12	KOM	
0121504	5	17	12	KOM	
0121505	5	25	16	KOM	
0121506	5	37	22	KOM	

**Uvrnuti Škopac**

Uvrnuti škopac od štančanog Inoxa AISI 316.

Kod	D mm	L mm	W mm	MJ	€
0121552	5	22	12	KOM	
0121557	6	36	14	KOM	

**Uski Ravni Škopac HS**

Uski ravni škopac HS od štančanog Inoxa AISI 316. Ispitano radno opterećenje (WL). Prekidno opterećenje (BL) je 4 puta veće od radnog opterećenja.

Kod	D mm	L mm	W mm	WL Kg	MJ	€
0121614	4	16	8	150	KOM	
0121615	5	20	8	250	KOM	
0121616	5	22	12	275	KOM	
0121617	6	25	13	325	KOM	

**Široki Ravni Škopac HS**

Široki ravni škopac HS od štančanog Inoxa AISI 316. Ispitano radno opterećenje (WL). Prekidno opterećenje (BL) je 4 puta veće od radnog opterećenja.

Kod	D mm	L mm	W mm	WL Kg	MJ	€
0121624	4	20	10	150	KOM	
0121625	5	20	11	250	KOM	
0121626	5	22	15	275	KOM	
0121627	6	25	17	325	KOM	

**Ravni Škopac HS s Vijkom**

Ravni škopac HS od štančanog Inoxa AISI 316 s vijkom. Ispitano radno opterećenje (WL). Prekidno opterećenje (BL) je 4 puta veće od radnog opterećenja.

Kod	D mm	L mm	W mm	WL Kg	MJ	€
0121664	4	16	10	125	KOM	
0121665	5	20	10	250	KOM	
0121666	6	25	15	325	KOM	

**Ravni Škopac s Prstenom**

Ravni škopac HS od štančanog Inoxa AISI 316 s prstenom. Ispitano radno opterećenje (WL). Prekidno opterećenje (BL) je 4 puta veće od radnog opterećenja.

Kod	D mm	L mm	W mm	WL Kg	MJ	€
0121507	5	17	8	187	KOM	
0121508	5	21	9	187	KOM	
0121509	5	36	14	250	KOM	
0121510	5	36	18	250	KOM	

**Ravni Škopac Key Pin**

Ravni škopac od štančanog Inoxa AISI 316 s okidnim mehanizmom.

Kod	D mm	L mm	W mm	MJ	€
0121562	4	22	11	KOM	
0121563	5	36	15	KOM	
0121564	6	40	15	KOM	

**Ravni Škopac Key Pin B**

Ravni škopac od štančanog Inoxa AISI 316 s okidnim mehanizmom i šipkom.

Kod	D mm	L mm	L1 mm	W mm	MJ	€
0121573	5	21	12	15	KOM	
0121574	6	25	12	15	KOM	
0121575	8	26	12	20	KOM	



Standardni Karabin

Standardni karabin od Inoxa AISI 316.

Kod	D mm	L mm	A mm	MJ	€
0211150	5	50	8	KOM	
0211160	6	60	9	KOM	
0211170	7	70	9	KOM	
0211180	8	80	10	KOM	
0211110	10	100	12	KOM	
0211112	11	120	16	KOM	
0211114	12	140	20	KOM	
0211116	13	160	26	KOM	



Standardni Karabin s Okom

Standardni karabin od Inoxa AISI 316 s okom.

Kod	D mm	L mm	A mm	O mm	MJ	€
0211350	5	50	8	7.5	KOM	
0211360	6	60	9	9	KOM	
0211370	7	70	9	10	KOM	
0211380	8	80	10	11.5	KOM	
0211310	10	100	12	14	KOM	
0211312	11	120	16	16.5	KOM	
0211314	12	140	20	18	KOM	
0211316	13	160	26	20	KOM	



Karabin Side

Karabin od Inoxa AISI 316 sa širokim bočnim otvaranjem. Ne zapliče sajle i konope.

Kod	D mm	L mm	A mm	MJ	€
0211791	8	80	22	KOM	
0211792	10	100	24	KOM	
0211793	11	120	26	KOM	



Karabin Wide

Karabin od Inoxa AISI 316 sa širokim otvaranjem.

Kod	D mm	L mm	A mm	MJ	€
0211891	8	85	18	KOM	
0211892	10	100	19	KOM	
0211893	11	125	26	KOM	

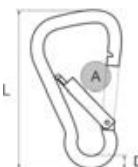

Karabin Wide Lock

Karabin od Inoxa AISI 316 sa širokim otvaranjem i sigurnosnom maticom.

Kod	D mm	L mm	A mm	MJ	€
0211860	6	60	10	KOM	
0211880	8	80	14	KOM	
0211810	10	100	20	KOM	
0211812	11	120	24	KOM	

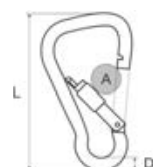

Karabin Wide Lock Eye

Karabin od Inoxa AISI 316 sa širokim otvaranjem, sigurnosnom maticom i okom.

Kod	D mm	L mm	A mm	O mm	MJ	€
0212060	6	60	10	9	KOM	
0212080	8	80	14	11	KOM	
0212010	10	100	20	14	KOM	
0212012	11	120	24	18	KOM	

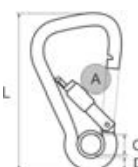

Standardni Karabin MTM

Standardni karabin od Inoxa 316 na prezentacijskom kartončiću. Radno opterećenje (WL) testirano i zajamčeno. Prekidno opterećenje (BL) je 4 puta veće od radnog opterećenja.

Kod	D mm	L mm	A mm	WL Kg	MJ	€
0211150C	5	50	8	90	KOM	
0211160C	6	60	9	130	KOM	
0211180C	8	80	10	180	KOM	
0211110C	10	100	12	280	KOM	



Standardni Karabin Eye MTM

Standardni karabin od Inoxa 316 s okom na prezentacijskom kartončiću. Radno opterećenje (WL) testirano i zajamčeno. Prekidno opterećenje (BL) je 4 puta veće od radnog opterećenja.

Kod	D mm	L mm	A mm	O mm	WL Kg	MJ	€
0211350C	5	50	8	7,5	90	KOM	
0211360C	6	60	9	9	130	KOM	
0211380C	8	80	10	11.5	180	KOM	
0211310C	10	100	12	14	280	KOM	



Standardni Karabin Kong

Karabin od Inoxa AISI 316 s glatkom kukicom. Ne zapliče konope.

Kod	D mm	L mm	A mm	MJ	€
0211605	5	50	7	KOM	
0211606	6	60	8	KOM	
0211607	7	72	10	KOM	
0211608	8	80	10	KOM	
0211610	10	103	15,5	KOM	
0211612	10,5	121	17	KOM	
0211613	13	160	30	KOM	

**Standardni Karabin s Okom Kong**

Karabin od Inoxa AISI 316 s glatkom kukicom i okom. Ne zapliče konope.

Kod	D mm	L mm	A mm	O mm	MJ	€
0211615	5	50	7	6	KOM	
0211616	6	60	8	7	KOM	
0211617	7	72	10	9	KOM	
0211618	8	80	10	10	KOM	
0211620	10	103	15,5	12	KOM	
0211622	10,5	121	17	15	KOM	
0211623	13	160	30	22	KOM	

**Karabin Kong Side**

Karabin od Inoxa AISI 316 sa širokim bočnim otvaranjem i glatkom kukicom. Ne zapliče konope.

Kod	D mm	L mm	A mm	MJ	€
0211781	8	80	22	KOM	
0211711	10	100	24	KOM	
0211712	11	120	26	KOM	

**Karabin s Okom Kong Side**

Karabin od Inoxa AISI 316 sa širokim bočnim otvaranjem, glatkom kukicom i okom. Ne zapliče konope.

Kod	D mm	L mm	A mm	O mm	MJ	€
0211981	8	80	24	11	KOM	
0211911	10	100	24	14	KOM	
0211912	11	120	26	18	KOM	

**Karabin Kong Wide**

Karabin od Inoxa AISI 316 sa širokim otvaranjem i glatkom kukicom. Ne zapliče konope.

Kod	D mm	L mm	A mm	MJ	€
0212150	5	52	9	KOM	
0212160	6	65	12	KOM	
0212180	8	85	18	KOM	
0212110	10	100	19	KOM	
0212112	11	125	26	KOM	

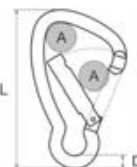
**Karabin s Okom Kong Wide**

Karabin od Inoxa AISI 316 sa širokim otvaranjem, glatkom kukicom i okom. Ne zapliče konope.

Kod	D mm	L mm	A mm	O mm	MJ	€
0212350	5	52	9	8	KOM	
0212360	6	65	12	9	KOM	
0212380	8	85	18	11	KOM	
0212310	10	100	19	14	KOM	
0212312	11	125	26	18	KOM	

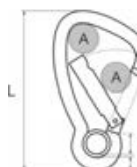
**Karabin Kong Out Lock**

Karabin od Inoxa AISI 316 s otvaranjem prema vani, glatkom kukicom i sigurnosnom maticom. Ne zapliče konope.

Kod	D mm	L mm	A mm	MJ	€
0211780	8	80	20	KOM	
0211710	10	100	24	KOM	

**Karabin s Okom Kong Out Lock**

Karabin od Inoxa AISI 316 s otvaranjem prema vani, glatkom kukicom, sigurnosnom maticom i okom. Ne zapliče konope.

Kod	D mm	L mm	A mm	O mm	MJ	€
0211980	8	80	20	11,5	KOM	
0211910	10	100	24	14	KOM	

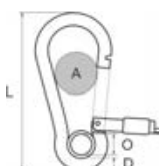

Standardni Okretni Karabin

Karabin od Inoxa AISI 316 s okretnim okom.

Kod	L mm	O mm	MJ	€
0211565	68	13	KOM	
0211585	85	18	KOM	

**Standardni Okretni Karabin Bolt**

Karabin od Inoxa AISI 316 s okretnim okom. Otvaranje na klip.

Kod	L mm	O mm	MJ	€
0211506	64	10	KOM	
0211508	80	13	KOM	

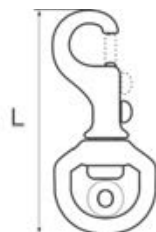
**Okretni Karabin Square Bolt**

Karabin od Inoxa AISI 316 s okretnim okom za prolaz trake. Otvaranje na klip.

Kod	L mm	O mm	MJ	€
0211516	61	13	KOM	
0211518	81	21	KOM	

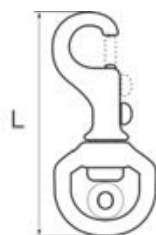
**Standardni Fiksni Karabin**

Karabin od Inoxa AISI 316 s fiksnim okom.

Kod	L mm	O mm	MJ	€
0211453	53	10	KOM	
0211473	73	16	KOM	

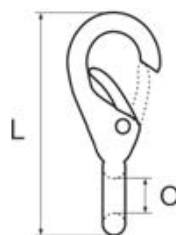
**Karabin s Prolaznim Okom**

Karabin od Inoxa AISI 316 s okom za prolaz trake.

Kod	A mm	C mm	MJ	€
0211450	48	25	KOM	

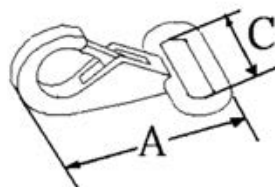
**Standardni Sigurnosni Karabin**

Sigurnosni karabin s okom za prolaz konopa/remena za sigurnosne pojaseve i sličnu opremu na jedrilicama. Vrlo čvrsta izrada od Inoxa AISI 316.

Kod	D mm	L mm	A mm	O mm	MJ	€
0212580	8	80	14	16	KOM	
0212510	10	100	20	20	KOM	

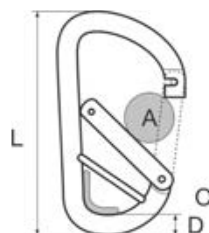
**Plosnati Sigurnosni Karabin**

Sigurnosni karabin s okom za prolaz konopa/remena za sigurnosne pojaseve i sličnu opremu na jedrilicama. Opremljen sigurnosnom bravom i zaštitama od kompozitnog materijala. Vrlo čvrsta izrada od Inoxa AISI 316.

Kod	L mm	A mm	O mm	MJ	€
0212611	100	16	24	KOM	

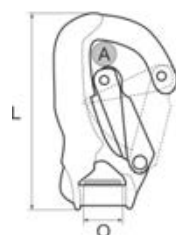

Otvoreni Karabin za Flok

Otvoreni karabin za flok od Inoxa AISI 316. Koristi se za pričvršćivanje škote na pramčani vijak. Može se sašiti na remen ili plombirati na konop, a zatim zakucati kraj karabina.

Kod	L mm	O mm	MJ	€
022252	52	8	KOM	
022265	65	10	KOM	

**Zatvoreni Karabin za Flok**

Zatvoreni karabin za flok od Inoxa AISI 316. Koristi se za pričvršćivanje floska na pramčani vijak. Može se sašiti na remen ili plombirati na konop.

Kod	L mm	O mm	MJ	€
0222350	50	7	KOM	
0222370	70	9	KOM	
0222310	100	14	KOM	

**Karabin Spi s Fiksnim Okom**

Fiksni karabin za spinaker od Inoxa AISI 316. Koristi se za škote i podigače spinakera ili floska. Škota/podigača može biti plombirana ili upletena.

Kod	L mm	O mm	MJ	€
0222550	55	9	KOM	
0222560	75	12	KOM	
0222590	99	15	KOM	

**Karabin Spi s Okretnim Okom**

Karabin za spinaker od Inoxa AISI 316. Koristi se za škote i podigače spinakera ili floska. Škota/podigača može biti plombirana ili upletena.

Kod	L mm	O mm	MJ	€
0222670	70	12	KOM	
0222690	90	16	KOM	
0222613	127	22	KOM	

**Karabin Spi s Okretnim Škopcem**

Karabin za spinaker od Inoxa AISI 316 s okretnim škopcem. Koristi se za škote i podigače spinakera ili floska. U slučaju da su konopi plombirani, moguće je zamijeniti osovinu karabina ukoliko je istrošena.

Kod	L mm	O mm	MJ	€
0222770	74	12	KOM	
0222790	94	14	KOM	
0222713	138	22	KOM	

**Otvoreni Karabin za Flok MTM**

Visokokvalitetni otvoreni karabin za flok od Inoxa AISI 316 na prezentacijskom kartončiću. Pouzdana kontrola kvalitete i završne obrade za uporabu u teškim morskim uvjetima. Radno opterećenje (WL) je testirano i zajamčeno. Prekidno opterećenje (BL) je 4 puta veće od radnog opterećenja.

Kod	L mm	O mm	WL Kg	BL Kg	MJ	€
022252C	50	9	90	360	KOM	
022265C	65	9	120	480	KOM	

**Zatvoreni Karabin za Flok MTM**

Visokokvalitetni zatvoreni karabin za flok od Inoxa AISI 316 na prezentacijskom kartončiću. Pouzdana kontrola kvalitete i završne obrade za uporabu u teškim morskim uvjetima. Radno opterećenje (WL) je testirano i zajamčeno. Prekidno opterećenje (BL) je 4 puta veće od radnog opterećenja.

Kod	L mm	O mm	WL Kg	BL Kg	MJ	€
0222350C	50	7	65	260	KOM	
0222370C	70	9	125	500	KOM	
0222310C	100	14	225	900	KOM	

**Karabin Spi s Fiksnim Okom MTM**

Visokokvalitetni karabin za spinaker od Inoxa AISI 316 na prezentacijskom kartončiću. Pouzdana kontrola kvalitete i završne obrade za uporabu u teškim morskim uvjetima. Radno opterećenje (WL) je testirano i zajamčeno. Prekidno opterećenje (BL) je 4 puta veće od radnog opterećenja.

Kod	L mm	O mm	WL Kg	BL Kg	MJ	€
0222560C	70	20	450	1800	KOM	
0222590C	100	20	830	3320	KOM	

**Karabin Spi s Okretnim Okom MTM**

Visokokvalitetni okretni karabin za spinaker od Inoxa AISI 316 na prezentacijskom kartončiću. Pouzdana kontrola kvalitete i završne obrade za uporabu u teškim morskim uvjetima. Radno opterećenje (WL) je testirano i zajamčeno. Prekidno opterećenje (BL) je 4 puta veće od radnog opterećenja.

Kod	L mm	O mm	WL Kg	BL Kg	MJ	€
0222670C	70	12	160	640	KOM	
0222690C	90	16	220	880	KOM	
0222613C	127	22	400	1600	KOM	

**Karabin Spi s Okretnim Škopcem MTM**

Visokokvalitetni okretni karabin za spinaker od Inoxa AISI 316 s okretnim škopcem na prezentacijskom kartončiću. Pouzdana kontrola kvalitete i završne obrade za uporabu u teškim morskim uvjetima. Radno opterećenje (WL) je testirano i zajamčeno. Prekidno opterećenje (BL) je 4 puta veće od radnog opterećenja.

Kod	L mm	O mm	WL Kg	BL Kg	MJ	€
0222770C	74	12	160	640	KOM	
0222790C	94	12	220	880	KOM	
0222713C	138	22	400	1600	KOM	



Mostić od Okrugle Šipke

Mostić od okrugle šipke sjajnog Inoxa. Prodaje se u pakiranju od 10 komada.

Kod	D mm	W mm	W1 mm	MJ	€
0333340	4	40	10	KOM	
0333350	5	51	12	KOM	
0333360	6	60	14	KOM	
0333363	8	63	15	KOM	

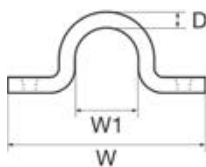
**Štancani Mostić S**

Mostić od štancanog Inoxa s uskom bazom. Prodaje se u pakiranju od 10 komada.

Kod	W mm	W1 mm	MJ	€
0333022	42	10	KOM	
0333024	45	13	KOM	
0333026	48	16	KOM	

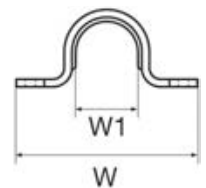
**Štancani Mostići L**

Mostić od štancanog Inoxa sa širokom bazom. Prodaje se u pakiranju od 10 komada.

Kod	W mm	W1 mm	MJ	€
0333213	45	13	KOM	
0333216	48	16	KOM	

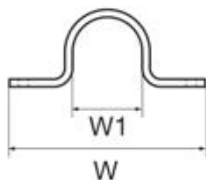
**Mostić s Prolazom za Remen**

Mostić od okrugle šipke sjajnog Inoxa s prolazom za remen. Prodaje se u pakiranju od 10 komada.

Kod	D mm	W mm	W1 mm	MJ	€
0333355	5	78	40	KOM	
0333362	6	92	50	KOM	

**Mostić na Ploči Pad Eye 2**

Mostić na ploči od Inoxa s 2 otvora.

Kod	D mm	L mm	W mm	MJ	€
0235045	5	45	15	KOM	
0235060	6	60	20	KOM	
0235080	8	80	26	KOM	

**Mostić na Ploči Pad Eye 4**

Mostić na ploči od Inoxa s 4 otvora.

Kod	D mm	L mm	W mm	MJ	€
0234035	5	35	30	KOM	
0234040	6	40	35	KOM	
0234050	8	50	40	KOM	

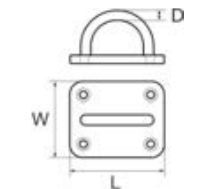
**Prsten na Ploči s 4 Oka**

Ploča s 4 oka i okruglim prstenom od Inoxa.

Kod	W mm	L mm	O mm	D mm	H mm	MJ	€
0234430	30	35	30	5	20	KOM	
0234435	35	40	40	6	26	KOM	
0234440	40	50	40	8	32	KOM	

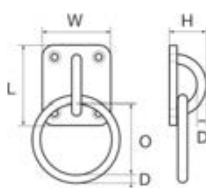
**Prsten na Ploči s 3 Oka**

Ploča s 3 oka i prstenom od Inoxa s podlogom.

Kod	L mm	W mm	D mm	MJ	€
0234336	65	50	6	KOM	
0234338	68	50	8	KOM	

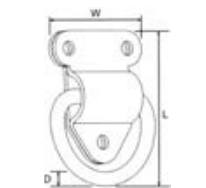
**Prsten na Ploči s 3 Oka H.D.**

Ploča s 3 oka i prstenom od lijevanog Inoxa. Izvršna kvaliteta i završna obrada.

Kod	L mm	W mm	D mm	MJ	€
0234346	44	44	6	KOM	
0234348	55	55	8	KOM	
0234350	73	75	10	KOM	

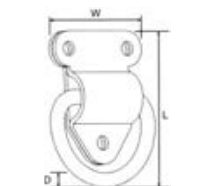

U-Vijak Bolt P

U-vijak od Inoxa sa stegnutom šipkom.

Kod	D mm	M mm	L mm	W mm	H mm	MJ	€
0230004	4	4	64	30	30	KOM	
0230005	5	5	80	35	40	KOM	
0230006	6	6	90	35	40	KOM	
0230008	8	8	100	35	50	KOM	
0230010	10	10	130	50	55	KOM	
0230012	12	12	150	60	65	KOM	

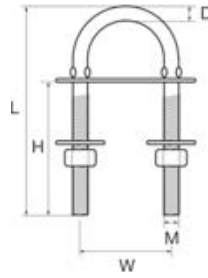
**U-Vijak Bolt S**

U-vijak od Inoxa sa zadebljanom šipkom.

Kod	D mm	M mm	L mm	W mm	H mm	MJ	€
0230105	6	5	78	36	48	KOM	
0230106	8	6	90	36	42	KOM	
0230108	10	8	100	45	52	KOM	
0230110	12	10	135	50	80	KOM	
0230112	14	12	150	60	85	KOM	

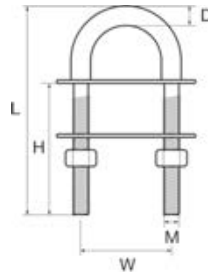
**U-Vijak Bolt Coat**

U-vijak od Inoxa s vodonepropusnom brtvom od PVC-a.

Kod	D mm	M mm	L mm	W mm	H mm	MJ	€
0230208	8	6	80	35	50	KOM	
0230210	10	8	100	40	65	KOM	
0230212	12	10	130	50	75	KOM	
0230214	14	12	155	63	90	KOM	

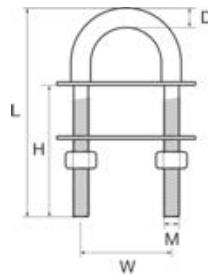
**U-Vijak Bolt Wtight**

Elegantni U-vijak od poliranog Inoxa sa zavarenom vodonepropusnom blokirajućom bazom.

Kod	D mm	M"	L mm	W mm	H mm	MJ	€
0230410	9,5	3/8	80	36	63	KOM	
0230412	12,7	1/2	140	46	113	KOM	

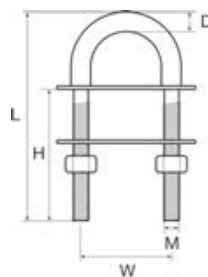
**U-Vijak Bolt G**

U-vijak od Inoxa sa zadebljanom šipkom i samozatvarajućim lako stezljivim maticama.

Kod	D mm	M mm	L mm	W mm	H mm	MJ	€
0230118	10	8	100	40	60	KOM	
0230120	12	10	100	40	48	KOM	
0230122	14	12	120	50	58	KOM	

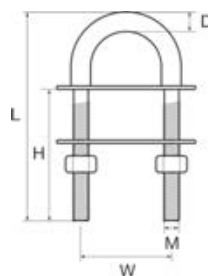

Zavareni Okasti Vijak

Vijak od Inoxa sa zavarenim okom.

Kod	M mm	H mm	W mm	D mm	MJ	€
0231040	6	40	13	6	KOM	
0231060	6	60	13	6	KOM	
0231180	8	70	17	8	KOM	
0231110	10	90	21	10	KOM	
0231112	12	105	25	12	KOM	

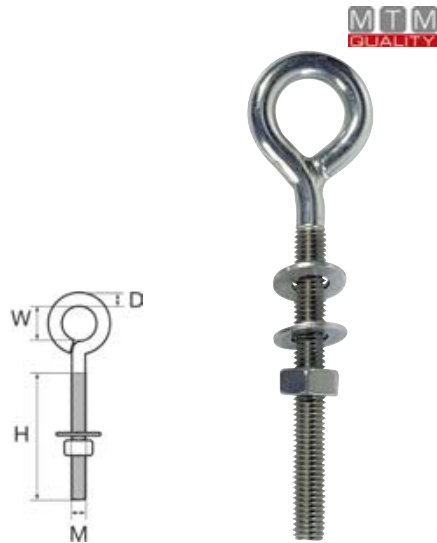
**Tokareni Okasti Vijak**

Vijak od Inoxa s tokarenim okom.

Kod	M mm	H mm	W mm	D mm	MJ	€
0231240	6	40	12	5	KOM	
0231260	6	60	12	5	KOM	
0231280	8	80	14	6	KOM	
0231210	10	100	16	8	KOM	
0231212	12	140	18	10	KOM	

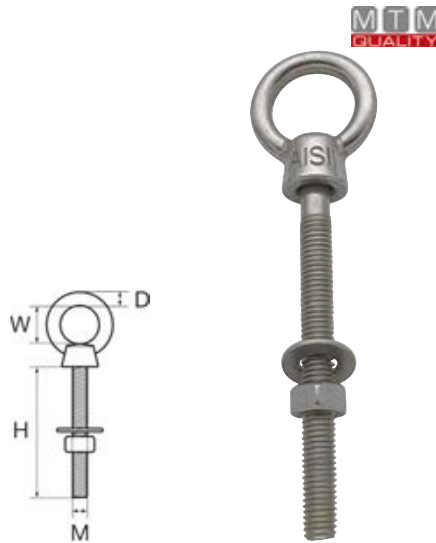
**Dvostruki Okasti Vijak**

Dvostruki okasti vijak od Inoxa s dva oka.

Kod	M mm	H mm	W mm	D mm	MJ	€
0233050	8	65	20	7	KOM	
0233080	10	85	25	8	KOM	

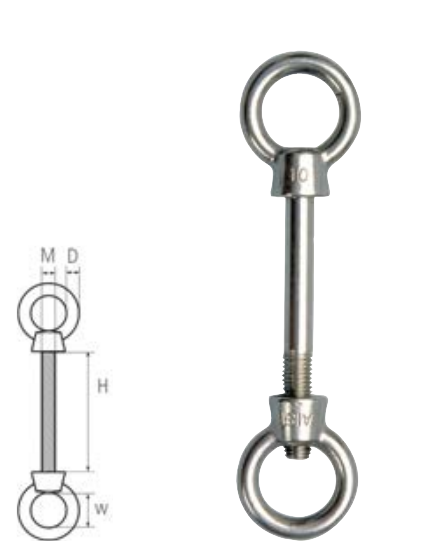
**Glava M Vijka**

Glava muškog okastog vijka od Inoxa.

Kod	M mm	W mm	D mm	MJ	€
0231606	6	15	6	KOM	
0231608	8	20	8	KOM	
0231610	10	25	10	KOM	
0231612	12	30	10	KOM	
0231616	16	35	14	KOM	

**Glava Ž Vijka**

Glava ženskog okastog vijka od Inoxa.

Kod	M mm	W mm	D mm	MJ	€
0231506	6	19	8	KOM	
0231508	8	19	8	KOM	
0231510	10	24	10	KOM	
0231512	12	28	12	KOM	
0231516	16	35	14	KOM	

**Okrugli Prsten**

Okrugli prsten od Inoxa.

Kod	D mm	W mm	MJ	€
0236020	3	20	KOM	
0236025	3	25	KOM	
0236028	4	25	KOM	
0236030	4	30	KOM	
0236040	5	40	KOM	
0236050	5	50	KOM	
0236055	6	50	KOM	
0236060	6	60	KOM	
0236065	8	60	KOM	
0236070	8	70	KOM	

**Polukružni (D) Prsten**

Polukružni (D) prsten od Inoxa.

Kod	D mm	W mm	L mm	MJ	€
0236332	3	17	20	KOM	
0236333	3	22	26	KOM	
0236342	4	22	27	KOM	
0236343	4	25	30	KOM	
0236353	5	25	30	KOM	
0236354	5	34	40	KOM	
0236364	6	35	40	KOM	
0236365	6	50	47	KOM	

**Trokutasti Prsten**

Trokutasti prsten od Inoxa.

Kod	D mm	L mm	MJ	€
0236384	5	30	KOM	
0236385	6	40	KOM	
0236386	6	50	KOM	
0236388	8	50	KOM	

**Polukružni (D) Prsten sa Šipkom**

Polukružni (D) prsten od Inoxa sa šipkom.

Kod	D mm	L mm	H mm	MJ	€
0236390	5	45	5,5	KOM	
0236391	6	50	7	KOM	
0236392	8	50	8	KOM	



Štancana Kukica od Inoxa

Štancana kukica od Inoxa.

Kod	L mm	W mm	H mm	MJ	€
0332500	19	33	12	KOM	

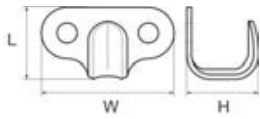

Kukica od Inoxa

Klasična kukica od Inoxa.

Kod	L mm	W mm	H mm	MJ	€
0331010	27	27	19	KOM	

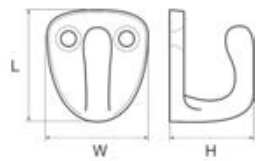

Uska Kukica od Inoxa

Uska kukica od Inoxa.

Kod	L mm	W mm	H mm	MJ	€
0331009	39	17	31	KOM	

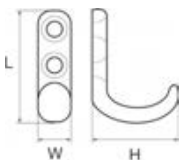

Zatvorena Kukica od Inoxa

Zatvorena kukica od Inoxa.

Kod	L mm	W mm	H mm	O mm	MJ	€
0331300	35	30	21	10	KOM	



Okidna Kukica od Inoxa

Opružna kukica od Inoxa za bokobrane i konope.

Kod	L mm	W mm	H mm	A mm	MJ	€
0331617	42	32	32	10	KOM	

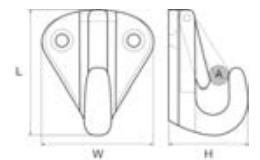

Dvostruka Kukica

Kukica od Inoxa AISI 316-A4 s 2 vrha.

Kod	L mm	W mm	MJ	€
1113505	50	10	KOM	
1113508	80	10	KOM	

New



Štancana Kromirana Kukica

Štancana kukica od Kromiranog Mesinga.

Kod	L mm	W mm	H mm	MJ	€
0332501	19	33	12	KOM	



Kromirana Kukica

Klasična kukica od Kromiranog Mesinga.

Kod	L mm	W mm	H mm	MJ	€
0331000	25	23	19	KOM	

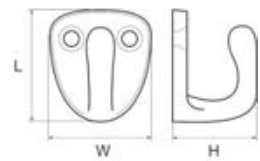

Uska Kromirana Kukica

Uska kukica od Kromiranog Mesinga.

Kod	L mm	W mm	H mm	MJ	€
0331002	36	18	20	KOM	



Zatvorena Kukica od Kromiranog Mesinga

Zatvorena kukica od Kromiranog Mesinga.

Kod	L mm	W mm	H mm	O mm	MJ	€
0331301	30	30	19	9	KOM	

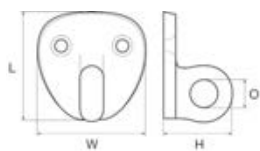

Okidna Kukica od Kromiranog Mesinga

Opružna kukica od Kromiranog Mesinga za bokobrane i konope.

Kod	L mm	W mm	H mm	A mm	MJ	€
0331604	36	33	25	8	KOM	
0331607	43	33	33	10	KOM	

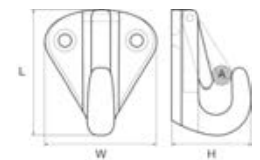

Bitva Light Weight

Mala bitva od Inoxa 316 za pričvršćivanje zastava i cerada. Podloga s 2 otvora za pričvršćivanje.

Kod	L mm	Razmak između rupa mm	MJ	€
1113506	67	10	KOM	
1113511	112	21	KOM	

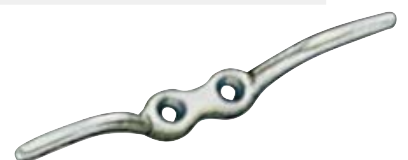

Kukica-Držac Šalica

Kukica za držanje šalice od Kromiranog Mesinga.

Kod	L mm	W mm	MJ	€
0335502	47	18	KOM	

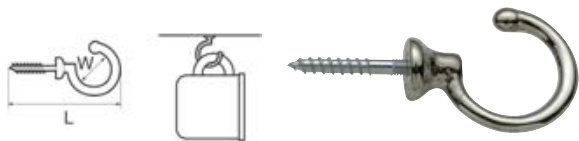

L Kukica s Vijkom

L kukica od Inoxa s vijkom.

Kod	L mm	H mm	MJ	€
0333450	40	15	KOM	
0333460	45	20	KOM	
0333470	50	22	KOM	



Jednostruka Vješalica

Jednostruka vješalica za odjeću od Mesinga.

Kod	Podloga mm	Mesing	MJ	€
0335601	15 x 40	Pozlaćeni	KOM	
0335501	15 x 40	Kromirani	KOM	



Vješalica s 3 Preklopne Kuke

Vješalica od Mesinga s 3 preklopne kuke.

Kod	Podloga mm	Mesing	MJ	€
0335303	73 x 36	Pozlaćeni	KOM	
0335305	73 x 36	Kromirani	KOM	



Dvostruka Vješalica Long

Dvostruka vješalica za odjeću od Mesinga.

Kod	Podloga mm	Mesing	MJ	€
0335308	75 x 70	Pozlaćeni	KOM	
0335309	75 x 70	Kromirani	KOM	



U Kukica s Vijkom

U kukica od Inoxa s vijkom.

Kod	L mm	W mm	MJ	€
0333650	35	10	KOM	
0333660	41	12	KOM	
0333670	50	17	KOM	



O Kukica s Vijkom

O kukica od Inoxa s vijkom.

Kod	L mm	W mm	MJ	€
0333850	33	7	KOM	
0333860	36	8	KOM	
0333870	46	10	KOM	



Dvostruka Vješalica

Dvostruka vješalica za odjeću od Mesinga.

Kod	mm	Mesing	MJ	€
0335302	40 x 55	Pozlaćeni	KOM	
0335301	40 x 55	Kromirani	KOM	



Vješalica s 4 Preklopne Kuke

Vješalica od Mesinga s 4 preklopne kuke.

Kod	Podloga mm	Mesing	MJ	€
0335304	73 x 36	Pozlaćeni	KOM	
0335306	73 x 36	Kromirani	KOM	



Vješalica na Izvlačenje

Vješalica na izvlačenje.

Kod	Podloga mm	Materijal	MJ	€
0335605	80 x 25	Inox	KOM	
0335606	75 x 25	Kromirani Mesing	KOM	



Vodoravna Najlonska Kukica

Vodoravna najlonska kukica. Prodaje se u pakiranju od 10 komada.

Kod	L mm	W mm	H mm	Boja	MJ	€
0332200	25	32	16	CRNA	KOM	
0332210	25	32	16	BIJELA	KOM	

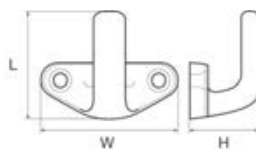

Okomita Najlonska Kukica

Okomita najlonska kukica. Prodaje se u pakiranju od 10 komada.

Kod	L mm	W mm	H mm	Boja	MJ	€
0331901	40	18	16	CRNA	KOM	
0331902	40	18	16	BIJELA	KOM	

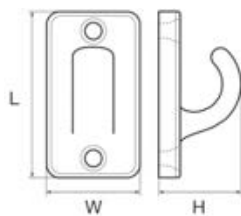

Ovalna Najlonska Kukica

Ovalna najlonska kukica. Prodaje se u pakiranju od 50 komada.

Kod	L mm	W mm	H mm	MJ	€
0331900	39	19	17	KOM	

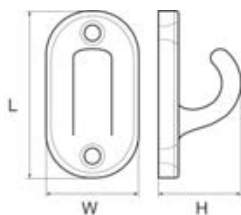

Najlonska Kukica s Prolaznim Okom

Najlonska kukica s prolaznim okom. Prodaje se u pakiranju od 10 komada.

Kod	L mm	W mm	ø mm	Boja	MJ	€
0332214	30	15	10	CRNA	KOM	
0332215	30	15	10	BIJELA	KOM	

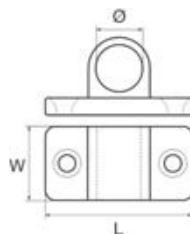

Najlonska Kuka za Vješanje Konopa

Najlonska kuka za vješanje konopa.

Kod	D mm	Š mm	V mm	MJ	€
0332912	80	57	50	KOM	
0332913	95	57	65	KOM	



Najlonska Kuka za Konope sa Stezaljkom

Najlonska kuka za konope sa stezaljkom za cijevi od 22<->25 mm.

Kod	MJ	€
0332915	KOM	



Najlonska Kuka sa Stezaljkom

Najlonska kuka sa stezaljkom za cijevi od 22<->25 mm.

Kod	MJ	€
0332910	KOM	

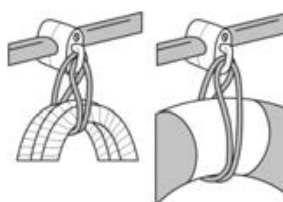

Bijela Kukica za Elastične Konope

Kukica od Bijelog Najlona za elastične konope.

Kod	Elastični konop ø mm	MJ	€
0332804	4	KOM	
0332805	5*	KOM	
0332806	6	KOM	
0332808	8	KOM	
0332810	10	KOM	

**Crna Kukica za Elastične Konope**

Kukica od Crnog Najlona za elastične konope.

Kod	Elastični konop ø mm	MJ	€
0332704	4	KOM	
0332705	5*	KOM	
0332706	6	KOM	
0332708	8	KOM	
0332710	10	KOM	

**Plosnata Kukica za Elastične Konope**

Široka i plosnata kukica od Najlona za pričvršćivanje na bokovima gumenjaka. Prodaje se u pakiranju od 10 komada.

Kod	Elastični konop ø mm	Boja	MJ	€
0332600	6/8	CRNA	KOM	
0332610	6/8	BIJELA	KOM	
0332620	6/8	SIVA	KOM	

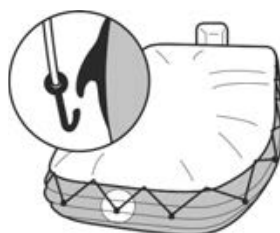
**Samoblokirajuća Kopča za Elastične Konope**

Samoblokirajuća Najlonska kopča za elastične konope.

Kod	Elastični konop ø mm	Boja	MJ	€
0332835	5/6	PLAVA	KOM	
0332836	5/6	CRNA	KOM	

**Bijela Samoblokirajuća Kopča za Elastične Konope**

Samoblokirajuća kopča od Bijelog Najlona za elastične konope.

Kod	Elastični konop ø mm	MJ	€
0332843	5<>6	KOM	
0332844	8	KOM	

**Crna Samoblokirajuća Kopča za Elastične Konope**

Samoblokirajuća kopča od Crnog Najlona za elastične konope.

Kod	Elastični konop ø mm	MJ	€
0332840	5<>6	KOM	
0332842	8	KOM	

**Kukica od Inoxa za Elastične Konope**

Kukica od Inoxa za elastične konope.

Kod	Elastični konop ø mm	MJ	€
0332816	6	KOM	
0332818	8	KOM	
0332820	10	KOM	



Kuka za Zatvaranje Vrata

Kuka od Kromiranog Mesinga za zaustavljanje vrata i vratašca.

Kod	mm	MJ	€
0334708	80	KOM	

**Kuka za Vrata od Inoxa s Dvostrukim Zglobom**

Kuka od Inoxa za zaustavljanje vrata i vratašca s dvostrukim zglobom.

Kod	mm	MJ	€
0334820	100	KOM	

**Standardni Zasun**

Zasun od Kromiranog Mesinga.

Kod	mm	MJ	€
0342412	115 x 25	KOM	

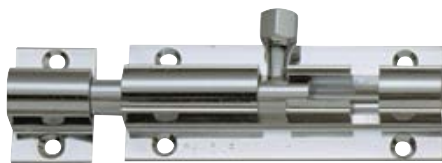
**Prigušeni Zasun Smooth Handle**

Zasun od Kromiranog Mesinga s protuvibracijskom ručkom obučenom u crni Najlon.

Kod	mm	MJ	€
0342491	85 x 30	KOM	

**Zasun Tmarine Barrel**

Zasun s opružnim mehanizmom za površinsku montažu od sjajnog Inoxa 316.

Kod	A mm	B mm	C mm	D mm	MJ	€
0342590	15	67	22	31	KOM	

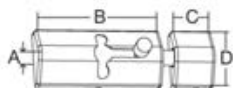
**Kuka za Zatvaranje Vrata s Dvostrukim Zglobom**

Kuka od Kromiranog Mesinga za zaustavljanje vrata i vratašca s dvostrukim zglobom.

Kod	mm	MJ	€
0334806	60	KOM	
0334808	80	KOM	
0334810	100	KOM	

**Zasun za Vrata**

Zasun za vrata od Kromiranog Mesinga.

Kod	mm	MJ	€
0335233	52 x 33	KOM	

**Zasun Smooth**

Zasun od Kromiranog Mesinga sa zaobljenim kutevima.

Kod	mm	MJ	€
0342459	59 x 27	KOM	
0342490	90 x 30	KOM	

**Zasun Smooth od Inoxa**

Zasun od Inoxa sa zaobljenim kutevima.

Kod	mm	MJ	€
0342580	75 x 30	KOM	
0342581	90 x 38	KOM	

**Zasun Tmarine Slide**

Zasun za površinsku montažu od sjajnog Inoxa 316. Ručka ugodna za hvatanje, klizi sa smanjenim trenjem.

Kod	A mm	B mm	C mm	D mm	E mm	F mm	MJ	€
0342595	123	32	30	60	25	13	KOM	

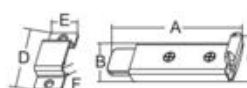

Zatvarač na Oprugu Locking Hasp

Zatvarač na pritisak od Inoxa za ormariće i podnice. Gumb na oprugu s prstenom i otvorom za lokot.

MTM

Kod	D mm	Podloga mm	MJ	€
0342101	56	50 x 34	KOM	

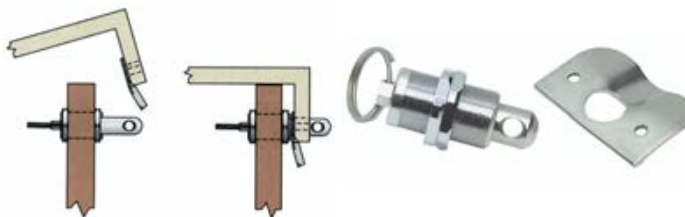
**Zatvarač na Oprugu Pin Latch**

Zatvarač od Inoxa 316 s gumbom na oprugu za fiksiranje, blokiranje ili zatvaranje sanduka i podnica.

MTM

Kod	A mm	B mm	C mm	D max mm	MJ	€
0342104	9,5	56,2	28	18,5	KOM	

**Zatvarač na Povlačenje Sundecker**

Southco Sundecker je zatvarač na daljinsko otvaranje/zatvaranje za vratašca, ormariće i sanduke (jednostavno povlačenjem remena). Montira se brzo i jednostavno na više strana i pozicija. Dužina remena 1 metar.

Kod	Dim mm	D remena	Strana	MJ	€
0342730	53 x 115	1 m	Sjever	KOM	
0342731	53 x 115	1 m	Jug	KOM	

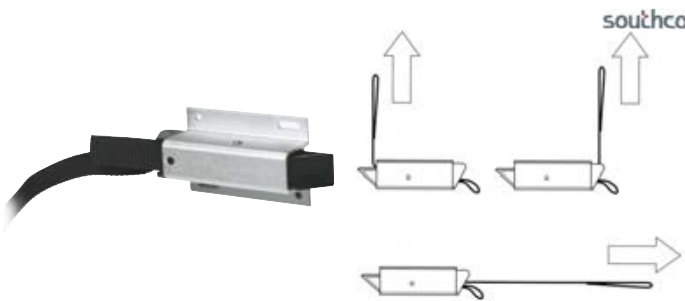
**Zatvarač na Pritisak Snap In**

Zatvarač na pritisak od Najlona i Gume za vratašca, ormariće, sanduke i podnice. Opremljen razmaknicom za podešavanje visine muškog priključka. Ugradnja baze u pregradu maksimalne debljine 13 mm.

Kod	Dim baze mm	Muški priključak dim mm	MJ	€
0342760	ø 39 x V46	ø 13 x V14	KOM	

**Zatvarač na Pritisak Snap Top**

Zatvarač na pritisak od Najlona i Gume za vratašca, ormariće, sanduke i podnice. Opremljen razmaknicom za podešavanje visine muškog priključka. Ugradnja baze u pregradu.

Kod	Dim baze mm	Muški priključak dim mm	MJ	€
0342750	ø 21 x V20	ø 13 x V11<>16	KOM	

**Zatvarač na Pritisak Snap Side**

Zatvarač na pritisak od Najlona i Gume za vratašca, ormariće, sanduke i podnice. Muški priključak se montira na nosač od Inoxa koji se može fiksirati na pregradu na željenoj visini. Baza se postavlja na površinu.

Kod	Dim baze mm	Inox nosač dim mm	MJ	€
0342752	ø 21 x V20	32 x 16 x V22	KOM	



Zatvarač na Pritisak Mini

Zatvarač na pritisak za ladice i male ormariće s Plastičnom bazom i priključkom.

Kod	Dim mm	MJ	€
0342700	30 x 7	KOM	

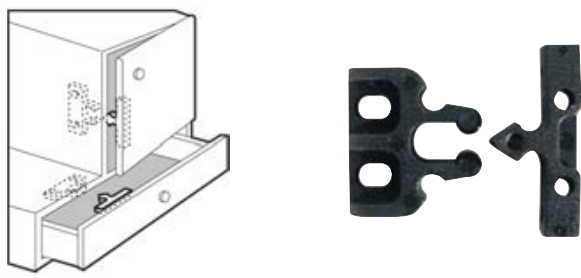
**Zatvarač na Pritisak Grabber**

Zatvarač na pritisak Southco Grabber za ladice i vrata s ojačanom Plastičnom bazom i priključkom.

Kod	Baza dim mm	MJ	€
0342704	48 x 28 x H13	KOM	

**Zatvarač na Pritisak Snappy**

Zatvarač na pritisak Southco Snappy od ojačane Plastike. Samopodesivo blokiranje otporno na vibracije.

Kod	Dim mm	MJ	€
0342710	37 x 38	KOM	

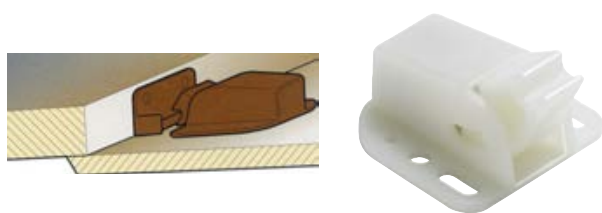
**Zatvarač na Pritisak**

Zatvarač na pritisak od Kromiranog Mesinga za vrata i vratašca.

Kod	Dim mm	MJ	€
0342802	60 x 12	KOM	

**Zatvarač na Pritisak OCS**

Zatvarač na pritisak za ladice i male ormariće s bazom i priključkom od Mesinga.

Kod	Dim mm	MJ	€
0342801	45 x 8	KOM	

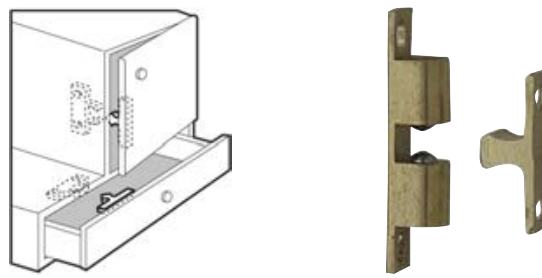
**Zatvarač sa Zubom od Mesinga**

Zatvarač sa zubom od Mesinga za vratašca i male ormariće. Koristi se s prolaznim ručkama ili bušenjem rupe na vratima.

Kod	MJ	€
0335015	KOM	

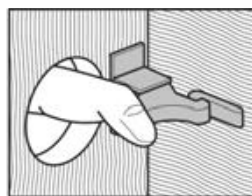
**Zatvarač na Pritisak Parrot**

Ugradbeni ili poluugradbeni zatvarač Southco Parrot s tijelom od ojačane Plastike. Opremljen pločicom koja apsorbira zvuk prilikom zatvaranja. S podesivim udarnim mehanizmom koji omogućuje da zatvarač ostane uvijek u ravni.

Kod	Dim mm	MJ	€
0342715	70 x 50	KOM	

**Zatvarač na Pritisak**

Zatvarač na pritisak od Inoxa za vrata i vratašca.

Kod	Dim mm	MJ	€
0342805	29 x 26	KOM	
0342806	40 x 32	KOM	



Zatvarač na Pritisak CG

Ugradbeni zatvarač na pritisak za vratašca, sanduke i podnice. Tijelo od ojačane Plastike.

Kod	Otvor \varnothing mm	Vanjski \varnothing mm	D mm	Ključ	MJ	€
0342224	50	60	6<>12	Ne	KOM	
0342225	50	60	8<>12	Da	KOM	

MTM

**Zatvarač na Pritisak Southco**

Southco ugradbeni zatvarač na pritisak za vratašca, sanduke i podnice. Tijelo od ojačane Plastike.

Kod	Otvor \varnothing mm	Vanjski \varnothing mm	D mm	Ključ	Boja	MJ	€
0342244	50	60	6<>12	Ne	BIJELA	KOM	
0342246	50	60	6<>12	Da	BIJELA	KOM	
0342243	50	60	6<>12	Ne	CRNA	KOM	
0342245	50	60	6<>12	Da	CRNA	KOM	

southco

**Zatvarač na Pritisak SS**

Ugradbeni zatvarač na pritisak za vratašca, sanduke i podnice. Tijelo od sjajnog Inoxa.

Kod	Otvor \varnothing mm	Vanjski \varnothing mm	D mm	Ključ	MJ	€
0342233	50	60	6<>12	Ne	KOM	
0342234	50	60	6<>12	Da	KOM	

**Zatvarač na Pritisak Evo**

Ugradbeni zatvarač na pritisak za vratašca, sanduke i podnice s velikom ručkom za bolji zahvat. Tijelo od sjajnog Inoxa. Ugradnja s vodonepropusnom brtvom.

Kod	Ref	Dim otvora mm	Vanjske dim mm	D mm	MJ	€
0342250	Okrugli	\varnothing 45	\varnothing 57	9<>22	KOM	
0342252	Kvadratni	45 x 45	57 x 57	9<>22	KOM	



Kompresijski Podizač Podnica R1

Okrugli kompresijski podizač podnica od Inoxa s podesivom šipkom. Vidljiv dio ploče je bez vijčanih otvora. Montira se s unutarnje strane pomoću vijaka. Koristi se za otvaranje i zatvaranje podnica i grotla.

Kod	A mm	D mm	C mm	T mm	MJ	€
0341007	60<>75	50	79	5<>25	KOM	

**Kompresijski Podizač Podnica Q1**

Pravokutni kompresijski podizač podnica od Inoxa s podesivom šipkom. Vidljiv dio ploče je bez vijčanih otvora. Montira se s unutarnje strane pomoću vijaka. Koristi se za otvaranje i zatvaranje podnica i grotla.

Kod	A mm	D mm	B mm	C mm	T mm	MJ	€
0341023	55<>75	60	63	78	8<>30	KOM	

**Kompresijski Podizač Podnica Q2**

Pravokutni kompresijski podizač podnica od Inoxa s podesivom šipkom. Montira se s vanjske strane pomoću vijaka. Koristi se za otvaranje i zatvaranje podnica i grotla.

Kod	A mm	D mm	B mm	C mm	T mm	MJ	€
0341025	55<>75	50	75	97	8<>30	KOM	

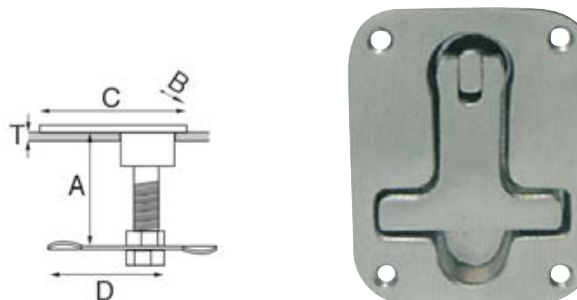
**Kompresijski Podizač Podnica Q4**

Kompresijski podizač podnica od Inoxa AISI s ugradbenom preklopnom pločom. S podesivom šipkom. Koristi se za otvaranje i zatvaranje podnica i grotla.

Cod.	A mm	B mm	C mm	D mm	E mm	F mm	UM	€
0341020	110	115	91	51	15	75	KOM	

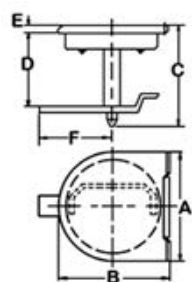
**Kompresijski Podizač Podnica R2**

Okrugli kompresijski podizač podnica od Inoxa s podesivom šipkom. Vidljiv dio ploče s ručkom koja sakriva vijčane otvore. Montira se s vanjske strane pomoću vijaka. Koristi se za otvaranje i zatvaranje podnica i grotla.

Cod.	A mm	B mm	C mm	T mm	Ključ	UM	€
0341005	58<>69	50	78	5<>45	Ne	KOM	
0341015	58<>69	50	78	5<>45	Da	KOM	



Kompresijski Podizač Podnica R3

Kompaktni okrugli kompresijski podizač podnica od Inoxa s podesivom šipkom. Vidljiv dio ploče s ručkom koja sakriva vijčane otvore. Montira se s vanjske strane pomoću vijaka. Koristi se za otvaranje i zatvaranje podnica i grotla. Šipka se može postaviti u normalnom položaju ili okrenuta (Rev) kako bi pokrivala sve potrebne debljine (A).

Kod	A mm	B mm	C mm	T mm	Ključ	MJ	€
0341003	20<>45 (45<>65 Rev)	62	64	5<>45	Ne	KOM	
0341013	20<>45 (45<>65 Rev)	62	64	5<>45	Da	KOM	



Kompresijski Podizač Podnica Q3

Kompaktni pravokutni kompresijski podizač podnica od Inoxa s podesivom šipkom. Vidljiv dio ploče s ručkom koja sakriva vijčane otvore. Montira se s vanjske strane pomoću vijaka. Koristi se za otvaranje i zatvaranje podnica i grotla. Šipka se može postaviti u normalnom položaju ili okrenuta (Rev) kako bi pokrivala sve potrebne debljine (A).

Kod	A mm	B mm	C mm	D mm	T mm	Ključ	MJ	€
0341004	20<>45 (45<>65 Rev)	64	64	60	8<>16	Ne	KOM	
0341014	20<>45 (45<>65 Rev)	64	64	60	8<>16	Da	KOM	



Kompresijski Podizač Podnica Q-Evo

Kompresijski podizač podnica s većom ručkom za bolji zahvat. Tijelo od poliranog Inoxa, s podesivom šipkom. Ugradnja s vanjske strane pomoću vijaka. Vodonepropusna brtva. Šipka se može postaviti u normalnom položaju ili okrenuta (Rev) kako bi pokrivala sve potrebne debljine (A).

Kod	A mm	B mm	C mm	D mm	T mm	Ključ	MJ	€
0341006	25<>43 (47<>63 Rev)	65	65	52	4<>42	Ne	KOM	
0341016	25<>43 (47<>63 Rev)	65	65	52	4<>42	Da	KOM	



Kompresijski Podizač Podnica Southco M1-20

Vodonepropusni IP65 kompresijski podizač podnica Southco od Inoxa više kvalitete s podesivom šipkom. Koristi se za otvaranje i zatvaranje podnica i grotla. Šipka se može postaviti u normalnom položaju ili okrenuta (Rev) kako bi pokrivala sve potrebne debljine (A).

Kod	A mm	C1 mm	C mm	T mm	Ključ	MJ	€
0341133	27<>40 (51<>64 Rev)	50	61,5	12<>22,5	Ne	KOM	
0341134	27<>40 (51<>64 Rev)	50	61,5	12<>22,5	Da	KOM	



Kompresijski Podizač Podnica Southco M1-25

Vodonepropusni IP65 kompresijski podizač podnica Southco od Inoxa više kvalitete s podesivom šipkom. Koristi se za otvaranje i zatvaranje podnica i grotla. Šipka se može postaviti u normalnom položaju ili okrenuta (Rev) kako bi pokrivala sve potrebne debljine (A).

Kod	A mm	C1 mm	C mm	T mm	Ključ	MJ	€
0341153	34<>48 (60<>75 Rev)	63,5	76	12<>22,5	Ne	KOM	
0341154	34<>48 (60<>75 Rev)	63,5	76	12<>22,5	Da	KOM	



Ugradbena Ručka od Inoxa SS2

Ugradbena ručka od Inoxa za podizanje podnica.

Kod	Dim mm	MJ	€
0340456	55 x 75	KOM	
0340476	57 x 76	KOM	

**Ugradbena Ručka od Inoxa S**

Klasična ugradbena ručka od štančanog Inoxa za podizanje podnica.

Kod	Dim mm	MJ	€
0340438	38 x 40	KOM	
0340455	55 x 65	KOM	

**Ugradbena Ručka od Inoxa Flush**

Okrugla i pravokutna ugradbena ručka od Inoxa za podizanje podnica.

Kod	Dim mm	MJ	€
0340481	ø 50	KOM	
0340482	50 x 50	KOM	

**Najlonska Ugradbena Ručka**

Najlonska ugradbena ručka za podizanje podnica sa širokom ručkom za udobniji zahvat.

Kod	Dim mm	MJ	€
0340470	ø 51 x H6	KOM	

**Ugradbena Ručka od Inoxa F**

Klasična ugradbena ručka od lijevanog Inoxa za podizanje podnica.

Kod	Dim mm	MJ	€
0340434	38 x 48	KOM	

**Ugradbeni Zasun SS**

Ugradbeni zasun od Inoxa za razna vratašca i poklopce.

Kod	Dim mm	MJ	€
0342205	57 x 40	KOM	

**Ugradbeni Zasun SS Smooth**

Ugradbeni zasun od Inoxa za razna vratašca i poklopce.

Kod	Dim mm	MJ	€
0342206	57 x 65	KOM	

**Ugradbena Brava s Ručkom**

Ugradbena ručka od Inoxa za vratašca i poklopce. Potrebno upotpuniti bravom i ključem

Kod	Dim mm	Dodatna oprema	MJ	€
0342202	50 x 55		KOM	
0343316		Brava V16 mm	KOM	
0343320		Brava V20 mm	KOM	
0343325		Brava V25 mm	KOM	
0343330		Brava V30 mm	KOM	



Ugradbena Ručka od Mesinga BS1

Pravokutna ugradbena ručka od Mesinga s ravnom drškom.

Kod	mm	Finiš	MJ	€
0340675	74 x 50 x 8	POLIRANI MESING	KOM	
0340676	74 x 50 x 8	KROMIRANI MESING	KOM	
0340696	92 x 63 x 9	POLIRANI MESING	KOM	
0340697	92 x 63 x 9	KROMIRANI MESING	KOM	

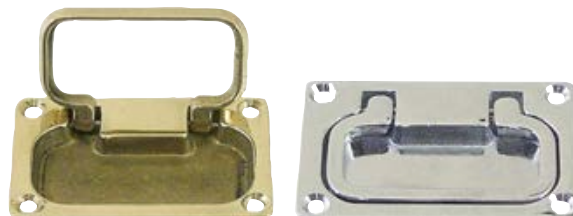
**Ugradbena Ručka od Mesinga BS2**

Pravokutna ugradbena ručka od Mesinga sa zakrivljenom drškom.

Kod	mm	Finiš	MJ	€
0340674	70 x 43 x 13	POLIRANI MESING	KOM	
0340683	70 x 43 x 13	KROMIRANI MESING	KOM	
0340684	80 x 49 x 13	POLIRANI MESING	KOM	
0340685	80 x 49 x 13	KROMIRANI MESING	KOM	

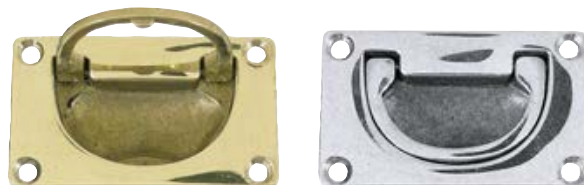
**Plastična Ugradbena Ručka PS1**

Kompaktne ugradbene ručke od ojačane Plastike.

Kod	mm	Boja	MJ	€
0341557	57 x 57	BIJELA	KOM	
0341558	57 x 57	KREM	KOM	

**Plastična Ugradbena Ručka PS2**

Ugradbena ručka od ojačane Plastike.

Kod	mm	MJ	€
4010000	85 x 175	KOM	

**Ugradbena Ručka od Tikovine TS1**

Pravokutna ugradbena ručka od Tikovine.

Kod	mm	MJ	€
0341265	65 x 40	KOM	

**Prolazna Ručka od Tikovine**

Prolazna ručka od Tikovine.

Kod	ø mm	MJ	€
0341230	30	KOM	

**Prolazna Ručka od Mesinga**

Ugradbena ručka od poliranog ili kromiranog Mesinga.

Kod	ø mm	Finiš	MJ	€
0341326	32	POLIRANI MESING	KOM	
0341327	32	KROMIRANI MESING	KOM	

**Jabučice Globe**

Jabučice od Kromiranog Mesinga za vratašca i ladice.

Kod	ø mm x V mm	MJ	€
0340922	15 x 20	KOM	
0340932	18 x 20	KOM	

**Jabučica Double-Cone**

Jabučica od Kromiranog Mesinga za vratašca i ladice.

Kod	ø mm x V mm	MJ	€
0340912	23 x 18	KOM	



Zatvarač na Gumb Southco Smart

Southco zatvarač na pritisak s otvaranjem na vuču: za otvaranje potrebno je povući jabučicu, za zatvaranje gurnuti vratašca. Jabučica se laganim pritiskom zatvara u ravni s vratima. Tijelo od ojačanog PC-a/ABS-a, otporno na koroziju i UV zrake. Debljina vratašca 1,5<->19 mm.

Kod	Otvor \varnothing mm	D mm	Debljina vratašca mm	Finiš	MJ	€
0343250	32	47	1,5<->19	KROMIRANI	KOM	



southco

Zatvarač na Pritisak Southco Turn

Zatvarač na pritisak Southco s okretnom jabučicom: jabučica ostaje u ravni prilikom zatvaranja, izlazi jednostavnim pritiskom kako bi omogućila sigurno hvatanje za otvaranje i zatvaranje vratašca. Zaokrenuti jabučicu za otvaranje, gurnuti vrata za zatvaranje. Podesiva spojnica. Tijelo i matica od PC-a/ABS-a, otporni na koroziju. Za ugradbena vratašca ili vratašca u ravni.

Kod	\varnothing mm	D mm	Debljina vrata mm	Finiš	Za vrata	MJ	€
0343245	32	47	1,5<->19	KROMIRANI	ugradbena	KOM	
0343246	32	47	1,5<->19	KROMIRANI	u ravni	KOM	

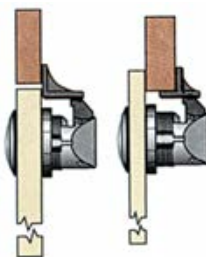

southco

Zatvarač na Pritisak Southco Point R

Zatvarač na pritisak Southco s gumbom u ravni i okruglom prirubnicom. Okidni gumb ostaje u ravni dok je zatvoren, a izlazi kad je otvoren. Tijelo i matica od Crnog Najlona, prirubnica i jabučica od Mesinga. Potrebno je upotpuniti fiksnom ili podesivom spojnicom.

Kod	\varnothing mm	D mm	Debljina vrata mm	Finiš	Spojnica	MJ	€
0343260	25	50	4<->25,4	KROMIRANI		KOM	
0343261	25	50	4<->25,4	SATEN		KOM	
0343271					Fiksna	KOM	
0343272					Podesiva	KOM	



southco

Zatvarač na Pritisak Southco Point Q

Zatvarač na pritisak Southco s gumbom u ravni i pravokutnom prirubnicom. Okidni gumb ostaje u ravni dok je zatvoren, a izlazi kad je otvoren. Tijelo i matica od Crnog Najlona, prirubnica i jabučica od Mesinga. Potrebno je upotpuniti fiksnom ili podesivom spojnicom.

Kod	\varnothing mm	D mm	Debljina vrata mm	Finiš	Spojnica	MJ	€
0343265	25	50	4<->25,4	KROMIRANI		KOM	
0343266	25	50	4<->25,4	SATEN		KOM	
0343271					Fiksna	KOM	
0343272					Podesiva	KOM	



southco

Zatvarač na Pritisak Novibra

Zatvarač na pritisak Novibra za vrata, vratašca, ladice i slično. Montira se brzo i jednostavno, otklanja buku uzrokovanu vibracijama motora. S vodootpornom glavom i tijelom od PC-a/ABS-a, otporan na koroziju i UV zrake.

Kod	Otvor \varnothing	D mm	Debljina vrata	Ploča	Ručka	MJ	€
0343254	38 mm	44,5	3<->22 mm	SATEN	SATEN	KOM	
0343255	38 mm	44,5	3<->22 mm	KROMIRANA	KROMIRANA	KOM	
0343256	38 mm	44,5	3<->22 mm	BIJELA	BIJELA	KOM	
0343259	38 mm	44,5	3<->22 mm	CRNA	CRNA	KOM	



southco

Zatvarač na Gumb F&S Compact

Zatvarač na gumb F&S za vratašca i ladice. Gumb od Kromiranog Mesinga, kućište od Bijele Plastike. Dimenzije: 50 x 35 mm.



Kod	Debljina vrata mm	MJ	€
0343113	>13<	KOM	
0343116	>16<	KOM	
0343119	>19<	KOM	

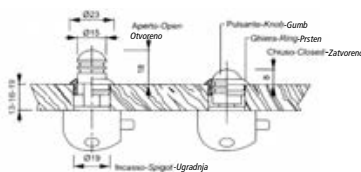

Zatvarač na Gumb F&S Std

Zatvarač na gumb F&S za vratašca i ladice. Plastičan, s gumbima od Kromiranog Mesinga. Potrebno upotpuniti s gumbom po izboru. Dimenzije kućišta brave: 70 x 50 mm.



Kod	Brava	Gumb	MJ	€
0343230	BIJELA		KOM	
0343231	KROMIRANA		KOM	
0343213		ø 23 mm za vrata >13< mm	KOM	
0343216		ø 23 mm za vrata >16< mm	KOM	
0343219		ø 23 mm za vrata >19< mm	KOM	
0343222		ø 23 mm za vrata >23< mm	KOM	



Brava na Gumb Southco

Brava na gumb Southco od ojačane Plastike i Najlona. Otporna na koroziju, s unutarnjim oprugama od Inoxa 302. Maksimalna debljina vratašca 12,5 mm.



Kod	ø mm	D mm	Debljina vrata mm	MJ	€
0343284	25	40	1,5<>12,5	KOM	



Mini Brava s Ključem

0343308 Mini brava s osovinom i ključem.
Osovina od legure Mesinga s prstenom od Inoxa.
0343309 Mini brava sa šipkom i ključem.
Osovina od legure Mesinga s prstenom od Inoxa.

Kod	M mm	H mm	MJ	€
0343308	12	10	KOM	
0343309	18	20	KOM	

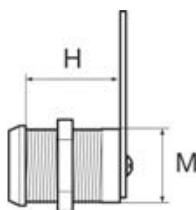

Brava Camlock

Camlock brava s ključem. Cilindar od legure Mesinga s prstenom od Inoxa. Šipka od Kromiranog Čelika.

Kod	M mm	H mm	MJ	€
0343316	19	16	KOM	
0343320	19	20	KOM	
0343325	19	25	KOM	
0343330	19	30	KOM	

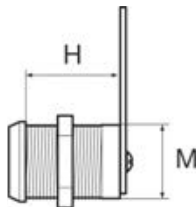

Brava Compact s Prihvatnom Pločom

Kompaktna brava s ključem i prihvatnom pločom. Tijelo od Kromiranog Mesinga s nehrđajućim elementima. Montaža u ravnini ili na površinu.

D = promjer cilindra

H = visina cilindra

Kod	Ref	mm	D mm	H mm	MJ	€
0343348	30110 ugradbena	58 x 55	19	22	KOM	
0343358	30111 vanjska	58 x 55	19	22	KOM	



Brava na Prislon s Jabučicom 3.656P

Brava na prislon, s ključem, sigurnosnim cilindrom, prihvatnom pločom u ravni i jabučicom za otvaranje iznutra. Tijelo od Kromiranog Mesinga s nehrđajućim elementima. Univerzalni smjer D/L. Razmak između rupa 83 x 36 mm.

Kod	mm	D mm	H mm	MJ	€
0343362	98 x 58	20	25	KOM	
0343363	98 x 58	20	30	KOM	

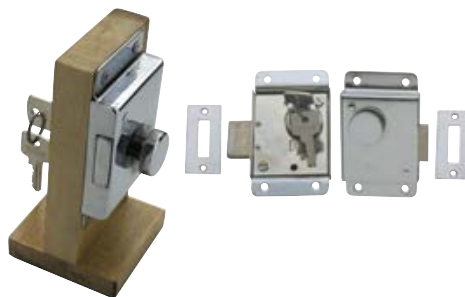
**Brava na Prislon s Jabučicom 3.656B**

Brava na prislon, s ključem, sigurnosnim cilindrom, kutnom prihvatnom pločom i jabučicom za otvaranje iznutra. Tijelo od Kromiranog Mesinga s nehrđajućim elementima. Univerzalni smjer D/L.

Kod	mm	D mm	H mm	MJ	€
0343360	98 x 58	20	25	KOM	
0343361	98 x 58	20	30	KOM	

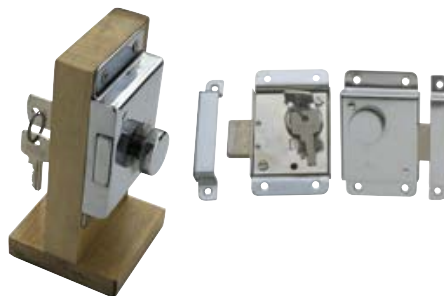
**Brava na Prislon 4.062P**

Brava na prislon s ključem i prihvatnom pločom u ravni. Tijelo od Kromiranog Mesinga s nehrđajućim elementima. Ručke se naručuju zasebno.

Kod	mm	Ruka	MJ	€
0343382	112 x 46	D	KOM	
0343372	112 x 46	L	KOM	

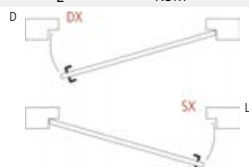
**Brava na Prislon 4.062B**

Brava na prislon s ključem i kutnom prihvatnom pločom. Tijelo od Kromiranog Mesinga s nehrđajućim elementima. Ručke se naručuju zasebno.

Kod	mm	Ruka	MJ	€
0343378	112 x 46	D	KOM	
0343379	112 x 46	L	KOM	

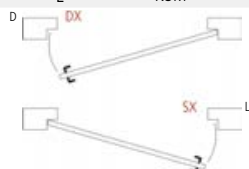
**Brava na Umetanje 4.021**

Brava na umetanje s ključem i prihvatnom pločom u ravni. Tijelo od Kromiranog Mesinga s nehrđajućim elementima. Ručke se naručuju zasebno.

Kod	mm	Zaštitna maska mm	Kvadratni trn	Ruka	MJ	€
0343381	93 x 44 >13<	133 x 15	8 x 8 mm	D	KOM	
0343371	93 x 44 >13<	133 x 15	8 x 8 mm	L	KOM	

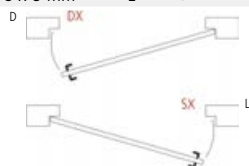
**Brava na Umetanje 2.035**

Brava na umetanje s ključem, ručkama i ugradbenom prihvatnom pločom u ravni. Tijelo od Kromiranog Mesinga s nehrđajućim elementima.

Kod	mm	Zaštitna maska mm	Kvadratni trn	Ruka	MJ	€
0343385	163 x 75 >13<	212 x 22	9 x 9 mm	D	KOM	
0343375	163 x 75 >13<	212 x 22	9 x 9 mm	L	KOM	

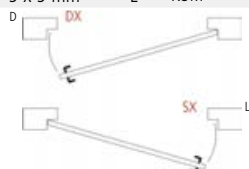

Brava na Umetanje Omni Spring-Bolt

Brava na umetanje izrađena od čvrstih materijala otpornih na koroziju. Jednostavna instalacija: dovoljno je odrezati po mjeri obris na ploči vrata. Opremljena ugrađenim ručkama. Zaštitne maske od Inoxa. Univerzalni smjer D/L.

Kod	mm	Debljina vrata mm	Prihvatna ploča	MJ	€
0345130	116 x 81,5	>12,7<		KOM	
0345131	116 x 81,5	>16<		KOM	
0344562			Prihvatna ploča (A = 3 mm)	KOM	
0344563			Prihvatna ploča (A = 5 mm)	KOM	
0344564			Prihvatna ploča (A = 7 mm)	KOM	



southco

**Brava na Umetanje 40.9714**

Brava na umetanje s prihvatnom pločom u ravlini i protuvibracijskim klizanjem. Tijelo od Kromiranog Mesinga s nehrđajućim elementima. Pogodna za tanka vrata. Ručke se naručuju zasebno.

Kod	mm	Ruka	MJ	€
0343345	68 x 60 >9<	D	KOM	
0343346	68 x 60 >9<	L	KOM	

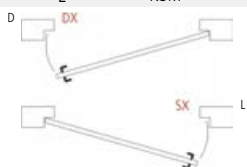
**Set Brava na Umetanje 4.020**

Komplet brave na umetanje za vrata debljine 15 mm. Uključuje prihvatnu ploču, ručke i dvije zaštitne maske od Inoxa.

Kod	Zaštitna maska mm	Ruka	MJ	€
0343520	80 x 70 >15<	D	KOM	
0343521	80 x 70 >15<	L	KOM	

**Brava na Umetanje 4.023**

Brava na umetanje s prihvatnom pločom u ravlini. Tijelo od Kromiranog Mesinga s nehrđajućim elementima. Ručke se naručuju zasebno.

Kod	mm	Zaštitna maska mm	Ruka	MJ	€
0343343	44 x 42,5 >12<	80 x 15	D	KOM	
0343344	44 x 42,5 >12<	80 x 15	L	KOM	

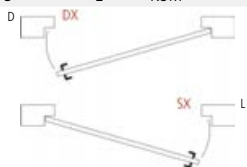
**Okretna Ručka-Brava**

Okretna ručka-brava od Kromiranog Mesinga s udarnim mehanizmom. Koristi se za zatvaranje hladnjaka, vratašca i roleta.

Kod	mm	MJ	€
0343820	157 x 30 x V35	KOM	

**Okretna Kutna Ručka-Brava**

Okretna ručka-brava od Kromiranog Mesinga s kutnim udarnim mehanizmom. Koristi se za zatvaranje hladnjala, vratašca i roleta do 30 mm.

Kod	mm	MJ	€
0343822	157 x 30 x V35	KOM	



Brava na Prislon s Unutarnjim Zaključavanjem 3.656B

Brava na prislon s unutarnjem zaključavanjem (privacy) i vanjskom prihvatnom pločom. Tijelo od Kromiranog Mesinga. Nehrdajući elementi. Univerzalni smjer D/L. Ručke se naručuju zasebno.

Kod	mm	MJ	€
0343391	72 x 46	KOM	
0343390	98 x 58	KOM	

**Brava na Prislon s Unutarnjim Zaključavanjem 3.656**

Brava na prislon s unutarnjem zaključavanjem (privacy) i prihvatnom pločom u ravnini. Tijelo od Kromiranog Mesinga. Nehrdajući elementi. Univerzalni smjer D/L. Ručke se naručuju zasebno.

Kod	mm	MJ	€
0343491	72 x 46	KOM	
0343490	98 x 58	KOM	

**Set Brava na Umetanje s Unutarnjim Zaključavanjem 70.1500**

Set brava na umetanje s unutarnjem zaključavanjem i protuvibracijskom prihvatnom pločom u ravnini. Tijelo od Kromiranog Mesinga. Nehrdajući elementi. S ručkama i zaštitnim maskama.

Kod	mm	Ruka	MJ	€
0343392	68 x 60 >9<	D	KOM	
0343393	68 x 60 >9<	L	KOM	

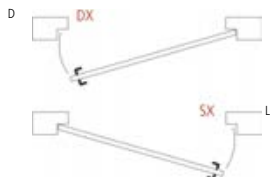
**Brava na Umetanje Omni Spring-Bolt s Unutarnjim Zaključavanjem**

Brava na umetanje izrađena od čvrstih materijala otpornih na koroziju. Opremljena unutarnjim sistemom zaključavanja (privacy). Jednostavna montaža: dovoljno je urezati obris po mjeri brave na panelu. S ugrađenim ručkama i zaštitnim maskama od Inoxa. Univerzalni smjer D/L.

Kod	mm	Debljina vrata mm	Prihvatna ploča	MJ	€
0345133	116 x 81,5	>12,7<		KOM	
0345134	116 x 81,5	>16<		KOM	
0344562			A = 3 mm	KOM	
0344563			A = 5 mm	KOM	
0344564			A = 7 mm	KOM	



southco

- BRAVE ZA KLIZNA VRATA -**Brava Mobella Secure**

Brava Mobella Secure za vrata s vodoravnim klizanjem. Tijelo od ojačanog Kompozita i Inoxa.

Kod	Dimenzije mm	Debljina vrata mm	Boja	MJ	€
0344520	55 x 87	>12<	CRNA	KOM	
0344521	55 x 87	>12<	BIJELA	KOM	



southco

Brava u Ravnini Mobella Flush Entry

Brava u ravnini od Anodiziranog Aluminijsa za klizna vrata, kao i za ugradbena vrata (10-15 cm veći put otvaranja od ostalih brava). Opremljena ključem i unutarnjim sigurnosnim otključavanjem, koji sprječava zaključavanje u kabini. Debljina vrata 12,5 mm ili 10 mm s razmaknikom na izbor. Univerzalni smjer D/L.

Kod	Izrez mm	Debljina vrata	Finiš	Dodatna oprema	MJ	€
0344510	63 x 114	>12,5< mm	ANODIZIRANI		KOM	
0344511	63 x 114	>12,5< mm	LAKIRANI		KOM	
0344512				Razmaknik 12,5 > 10 mm	KOM	

**Brava u Ravnini Mobella Flush Oval**

Brava u ravnini od Inoxa za klizna vrata, kao i za ugradbena vrata (10-15 cm veći put otvaranja od ostalih brava). Opremljena ključem i unutarnjim sigurnosnim otključavanjem, koji sprječava zaključavanje u kabini. Debljina vrata 12,5 mm ili 10 mm s razmaknikom na izbor. Univerzalni smjer D/L.

Kod	Izrez mm	Debljina vrata	Dodatna oprema	MJ	€
0344516	63 x 114	>12,5< mm		KOM	
0344512			Razmaknik 12,5 > 10 mm	KOM	

**Ugradbena Brava Mobella Talon**

Ugradbena brava za klizna vrata od Aluminijsa, Stakloplastike ili Drva. Vrlo otporna na sol i na koroziju. S Positive-Grip mehanizmom koji drži zatvorena vrata čak i u ekstremnim uvjetima. Univerzalni smjer D/L.

Kod	Debljina vrata mm	MJ	€
0344812	23<>27	KOM	

**Set Brava na Umetanje 4.070**

Brava na umetanje za klizna vrata opremljena ručkama, ključem, prihvatnom pločom u ravnini i zaštitnim maskama od Inoxa. Nehrđajući elementi. Univerzalni smjer D/L.

Kod	Dim mm	Zaštitna maska mm	Kvadratni trn mm	MJ	€
0343383	140 x 70 >12<	140 x 15	8 x 8	KOM	

**Set za Bravu na Umetanje 3.448**

Brava na umetanje za klizna vrata opremljena ručkama u ravnini, ključem, prihvatnom pločom u ravnini i zaštitnim maskama od Inoxa. S nehrđajućim elementima. Minimalna debljina vrata 20 mm. Univerzalni smjer D/L.

Kod	mm	Zaštitna maska mm	Debljina vrata mm	MJ	€
0343386	158 x 87	112 x 15	Najmanje >20<	KOM	



Ručke s Ovalnom Kvakom

Ručke od Kromiranog Mesinga s ovalnom kvakom.

Kod	L mm	H mm	Kvadratni trn mm	MJ	€
0343400	51	26	8	KOM	

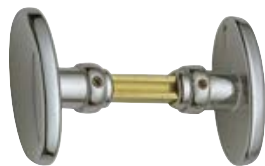
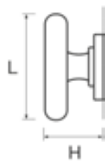
**Ručke s Ovalnom Kvakom i Prstenom**

Ručke od Kromiranog Mesinga s ovalnom kvakom i prstenom.

Kod	L mm	H mm	Kvadratni trn mm	MJ	€
0343401	51	26	8	KOM	

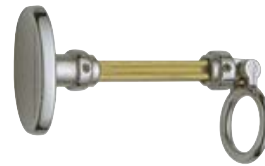
**Standardne Ručke**

Ručke od Kromiranog Mesinga sa zaobljenim vrhovima protiv zakačivanja.

Kod	L mm	H mm	Kvadratni trn mm	MJ	€
0343402	80	36	8	KOM	

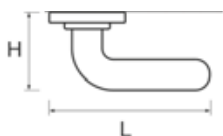
**Ručke Kata**

Ergonomske ručke od Kromiranog Mesinga.

Kod	L mm	H mm	Kvadratni trn mm	MJ	€
0343418	85	20	8	KOM	

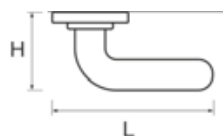
**Ručke Style**

Dizajnerske ručke od Kromiranog Mesinga.

Kod	L mm	H mm	Kvadratni trn mm	MJ	€
0343816	124	46	8	KOM	

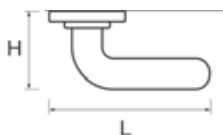
**Ručke Style 2**

Dizajnerske ručke od Kromiranog Mesinga s umetkom.

Kod	L mm	H mm	Kvadratni trn mm	MJ	€
0343817	124	46	8	KOM	

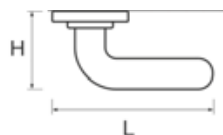
**Ručke No Catch 2**

Ručke od Kromiranog Mesinga s oblikovanim vrhovima protiv zakačivanja.

Kod	L mm	H mm	Kvadratni trn mm	MJ	€
0343818	123	55	8	KOM	

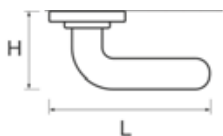
**Ručke No Catch 4**

Ručke od Kromiranog Mesinga za ugradnju u ravnini protiv bilo kakvog zakačivanja.

Kod	L mm	H mm	Kvadratni trn mm	MJ	€
0343819	133	42	8	KOM	

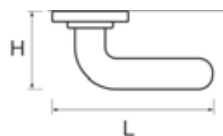
**Ukrasna Rozeta za Ručke**

Ukrasna rozeta za ručke od Kromiranog Mesinga.

Kod	Ref	MJ	€
0343410	Okrugla	KOM	
0343412	Ovalna	KOM	

**Ukrasna Rozeta Extra za Ručke**

Ukrasna rozeta extra za ručke od Kromiranog Mesinga.

Kod	ø mm	MJ	€
0343415	60	KOM	



Kromirana Ručkica

Ručkica za vrata od sjajnog Kromiranog Mesinga.

Kod	D mm	MJ	€
0340807	75	KOM	

**Ručka od Kromiranog Mesinga**

Ručka od Kromiranog Mesinga. Pričvršćuje se s unutarnje strane pomoću vijaka od 6 mm.

Kod	D mm	V mm	MJ	€
0340810	97	30	KOM	

**Ručka od Inoxa**

Ručka za vrata od Inoxa. Promjer ručke 10 mm, otvori za vijke 5 mm.

Kod	D mm	V mm	MJ	€
0340814	140	38	KOM	

**Ručka Grip od Inoxa**

Ručka od poliranog Inoxa AISI 316 s ergonomskim zahvatom. Pričvršćuje se s dva prolazna vijaka M6.

Kod	D mm	V mm	MJ	€
0340850	170	32	KOM	

**Ručka Inox Stud**

Ručka od sjajnog Inoxa. Montira se pomoću 2 skrivena vijka od 8 mm.

Kod	D mm	V mm	MJ	€
0340819	170	40	KOM	

**Ručka Inox Screw**

Ručka od sjajnog Inoxa. Montira se pomoću 2 prolazna vijka.

Kod	D mm	V mm	MJ	€
0340818	170	40	KOM	

**Kratka Ručka**

Kratka ručka (14 cm) od krutog PVC-a. S vidljivom montažom vijaka.

Kod	D mm	V mm	Boja	MJ	€
0340710	140	40	SIVA	KOM	
0340711	140	40	CRNA	KOM	
0340712	140	40	BIJELA	KOM	

**Kratka Ručka Sidney**

Kratka ručka (20 cm) od mekanog PVC-a s ojačanom jezgrom. Montaža s ugradbenim prolaznim vijcima.

Kod	D mm	V mm	Boja	MJ	€
0340724	205	55	TAMNO SIVA 7046	KOM	
0340726	205	55	SVJETLO SIVA 7035	KOM	



Držač na Pritisak SS

Držač na pritisak od Inoxa za vrata i vratašča.

Kod	Dim mm	MJ	€
0342805	29 x 26	KOM	
0342806	40 x 32	KOM	

**Držač Vrata s Kukom**

Držač vrata od Kromiranog Mesinga s kukom.

Kod	A mm	B mm	MJ	€
0336435	40	35	KOM	
0336445	50	45	KOM	

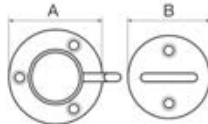
**Magnetski Držač Vrata Mag0**

Magnetski držač za vrata i vratašča od Kromiranog Mesinga s podesivim magnetom do 20°. Sastavljen od dva dijela: jedan se montira izvana, a drugi je ugradbeni.

Kod	Dim mm	MJ	€
0336101	ø 39 x V26	KOM	

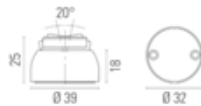
**Magnetski Držač Vrata Mag2**

Magnetski držač za vrata i vratašča od Kromiranog Mesinga s podesivim magnetom do 20°. Opremljen odgovarajućom pločicom.

Kod	Dim mm	MJ	€
0336107	ø 39 x H70	KOM	

**Magnetski Držač Vrata Mag1**

Magnetski držač za vrata i vratašča. Sastavljen od dva magnet: jedan, s bazom-nosačem, montira se na podu, a drugi na vratima. Tijelo od Kromiranog Mesinga.

Kod	mm	MJ	€
0336102	34 x 40	KOM	

**Magnetski Držač Vrata Mag3**

Magnetski držač za vrata i vratašča od Inoxa. Sastavljen od dva magnet: jedan, s bazom-nosačem, montira se na podu, a drugi na vratima.

Kod	A mm	B mm	C mm	D mm	E mm	MJ	€
0336105	42	38	18	15	47	KOM	

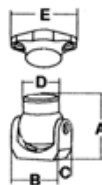
**Magnetski Držač Vrata Mag-PF1**

Magnetski držač za vrata i vratašča. Sastavljen od dva magnet: jedan se montira izvana, a drugi je ugradbeni. Tijelo od ojačane Plastike. Snaga držanja 2,5 kg.

Kod	L mm	L1 mm	H mm	H1 mm	MJ	€
0336120	62	46	15	10	KOM	

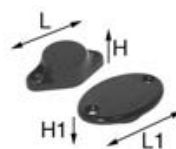

Standardni Zatvarač s Držačem Lokota

Zatvarač na preklop od Inoxa s držačem lokota.

Kod	mm	MJ	€
0343013	100 x 45	KOM	

**Zatvarač u Ravnini s Držačem Lokota**

Zatvarač na preklop u ravnini od Inoxa s držačem lokota.

Kod	mm	MJ	€
0343011	100 x 30	KOM	

**Okomiti Zatvarač s Držačem Lokota**

Okomiti zatvarač na preklop od Inoxa s držačem lokota.

Kod	mm	MJ	€
0343012	100 x 30	KOM	

**Podesivi Zatvarač s Držačem Lokota**

Zatvarač na preklop od Inoxa s podesivom polugom i držačem lokota.

Kod	mm	MJ	€
0343006	66<->75	KOM	
0343007	115<->125	KOM	

**Zatvarač s Držačem Lokota i Fiksним Okom**

Okretni zatvarač na preklop od Inoxa s držačem lokota i fiksnim okom.

Kod	mm	MJ	€
0342028	71 x 28	KOM	

**Zatvarač s Držačem Lokota i Okretnim Okom**

Okretni zatvarač na preklop od Inoxa s držačem lokota i okretnim okom.

Kod	mm	MJ	€
0342029	69 x 30	KOM	

**Klasični Zatvarač s Držačem Lokota**

Klasični okretni zatvarač na preklop od Inoxa s držačem lokota.

Kod	mm	MJ	€
0342034	72 x 34	KOM	

**Okretni Zatvarač s Bravom**

Okretni zatvarač na preklop od Inoxa s bravom.

Kod	mm	MJ	€
0342200	76 x 34	KOM	



Preklopni Zatvarač s Držačem Lokota

Preklopni zatvarač od Kromiranog Mesinga s držačem lokota.

Kod	mm	MJ	€
0343003	100 x 45	KOM	

**Preklopni Zatvarač s Držačem Lokota Extra**

Preklopni zatvarač od Kromiranog Mesinga s držačem lokota i nevidljivim otvorima za vijke.

Kod	mm	MJ	€
0343004	82 x 30	KOM	

**Okomiti Preklopni Zatvarač**

Okomiti preklopni zatvarač od Kromiranog Mesinga.

Kod	mm	MJ	€
0343002	70 x 35	KOM	

**Preklopni Zatvarač u Ravnini**

Preklopni zatvarač u ravnini od Kromiranog Mesinga.

Kod	mm	MJ	€
0343001	70 x 35	KOM	

**Preklopni Zatvarač s Držačem Lokota i Dvostrukim Zglobom**

Preklopni zatvarač od Kromiranog Mesinga s držačem lokota i dvostrukim zglobom.

Kod	mm	MJ	€
0342035	150 x 35	KOM	

**Zatvarač Leptir**

Zatvarač leptir od Kromiranog Mesinga za vratašca i prozore. Dimenzije baze-leptira: 38 x 15 mm. Razmak između rupa 26 mm. Dimenzije prihvatne ploče: 40 x 22 mm. Razmak između rupa 10 mm.

Kod	mm	MJ	€
0343100	40 x 38	KOM	

**Amortizirani Zatvarač Soft Latch**

Zatvarač od amortiziranog Termoplastičnog Elastomera za vratašca i sanduke. Zakovica, nosač i priključci od Inoxa.

Kod	D zatvoren	D otvoren	Boja	MJ	€
0343015	105	97,5	CRNA	KOM	
0343016	105	97,5	BIJELA	KOM	

**Zatvarač Southco F7**

Zatvarač od fleksibilnog termoplastičnog elastomera, otporan na UV zrake, apsorbira i smanjuje vibracije. Idealan za vratašca, sanduke i ledenice.

Kod	A mm	B mm	C mm	D mm	MJ	€
0343020	112	62	25	19	KOM	



Lokoti Hardinox sa Standardnim Lukom

Lokoti sa standardnim lukom od sjajnog Inoxa. Čvrsti, izdržljivi i sigurni, otporni na sol i morske uvjete.

Kod	A mm	B mm	E mm	D mm	C mm	MJ	€
0344430	30	27.3	15.8	4.8	17.0	KOM	
0344440	40	33.0	22.6	6.4	23.8	KOM	
0344450	50	40.3	29.5	7.9	27.9	KOM	

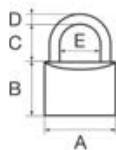

MTM

Lokoti Hardinox s Dugim Lukom

Lokoti s dugim lukom od sjajnog Inoxa. Čvrsti, izdržljivi i sigurni, otporni na sol i morske uvjete.

Kod	A mm	B mm	E mm	D mm	C mm	MJ	€
0344433	30	27.3	15.8	4.8	32	KOM	
0344444	40	33.0	22.6	6.4	38	KOM	
0344455	50	40.3	29.5	7.9	49	KOM	

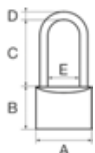

MTM

Set Lokota 4+1 Hardinox Master Key

Komplet od 5 lokota Hardinox od 30 mm (4 standardna lokota + 1 dugi lokot). Univerzalni ključ za sve lokote. Ključevi u paru po pojedinom lokotu uključeni.

Kod	A mm	B mm	E mm	D mm	C mm	C1 mm	MJ	€
0344463	30.0	27.3	15.8	4.8	17.0	32.0	PAK	

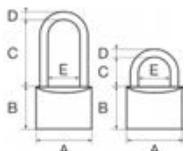

MTM

Sef VSAFE Display

Sef s tipkovnicom za korisničku lozinku, s LED zaslonom (osim 0344000) i unutarnjim LED svjetlom.

W = Širina

L = Dužina

H = Visina

Kod	Dim mm	Težina Kg	MJ	€
0344000	W310 x L200 x H200	4	KOM	
0344001	W350 x L270 x H250	11	KOM	
0344002	W420 x L370 x H200	13	KOM	
0344003	W508 x L380 x H200	15	KOM	



VITRIFRIGO

Sef VSAFE Display Top

Sef za ladicu s otvorom s gornje strane, tipkovnicom za korisničku lozinku, LED zaslonom i unutarnjim LED svjetlom.

W = Širina

L = Dužina

H = Visina

Kod	Dim mm	Težina Kg	MJ	€
0344004	W350 x L400 x H130	12	KOM	
0344005	W390 x L380 x H180	13	KOM	



VITRIFRIGO

Lagani Šarnir Knjiga

Lagani šarnir u obliku knjige od Inoxa.

Kod	D mm	W mm	H mm	MJ	€
0401025	0.8	25	30	KOM	
0401035	0.8	35	40	KOM	
0401040	0.8	40	50	KOM	

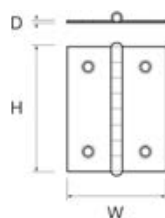
**Klasični Šarnir Knjiga**

Klasični šarnir u obliku knjige od Inoxa.

Kod	D mm	W mm	H mm	MJ	€
0401340	1.5	40	40	KOM	
0401360	1.5	40	60	KOM	
0401370	1.5	50	75	KOM	

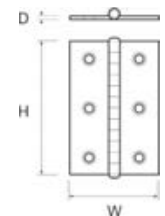
**Srednji Šarnir Knjiga**

Srednji šarnir u obliku knjige od Inoxa.

Kod	D mm	W mm	H mm	MJ	€
0401380	1.5	60	80	KOM	
0401382	1.5	80	80	KOM	

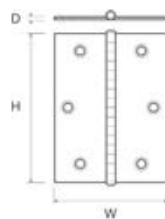
**Veliki Šarnir Knjiga**

Veliki šarnir u obliku knjige od Inoxa.

Kod	D mm	W mm	H mm	MJ	€
0401385	2	100	100	KOM	

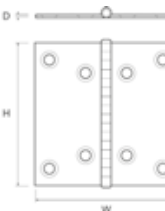
**Šarnir Keks**

Šarnir u obliku keksa od Inoxa.

Kod	mm	MJ	€
0400075	V40 x D70	KOM	

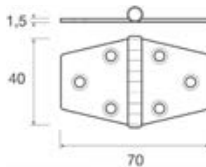
**Ekscentrični Šarnir**

Ekscentrični šarnir od Inoxa.

Kod	mm	MJ	€
0402057	V40 x D55	KOM	

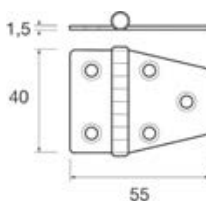
**Šarnir Offset Short**

Kratki izbočeni ekscentrični šarnir od Inoxa.

Kod	mm	MJ	€
0403550	V40 x D55	KOM	

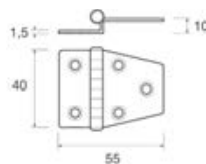
**Šarnir s Preklopnim Zglobom 180°**

Šarnir sa zglobom na preklop 180° od Inoxa za stolne plohe i ormariće.

Kod	mm	MJ	€
0402208	V30 x D80	KOM	

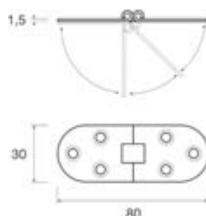

Kvadratni Šarnir S

Mali šarnir od sjajnog Inoxa Extracrome.

Standard = Gornji zglobni klin

Centerpin = Središnji zglobni klin

Kod	Ref	mm	MJ	€
0450036	Standard	V40 x D37	KOM	
0450136	Centerpin	V40 x D37	KOM	

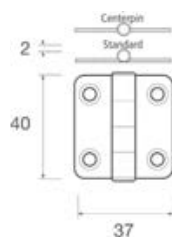
**Šarnir u Obliku Keksa SQ/S**

Mali šarnir u obliku keksa od sjajnog Inoxa Extracrome sa zaobljenim uglovima.

Standard = Gornji zglobni klin

Centerpin = Središnji zglobni klin

Reverse = Donji zglobni klin

Kod	Ref	mm	MJ	€
0450037	Standard	V43 x D38+38	KOM	
0450137	Centerpin	V43 x D38+38	KOM	
0450237	Reverse	V43 x D38+38	KOM	

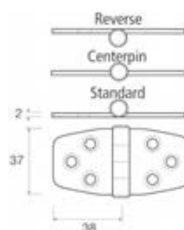
**Šarnir u Obliku Keksa SR/S**

Zaobljeni šarnir u obliku keksa od sjajnog Inoxa Extracrome.

Standard = Gornji zglobni klin

Centerpin = Središnji zglobni klin

Reverse = Donji zglobni klin

Kod	Ref	mm	MJ	€
0450039	Standard	V39 x D37+37	KOM	
0450139	Centerpin	V39 x D37+37	KOM	
0450239	Reverse	V39 x D37+37	KOM	

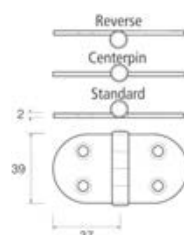
**Šarnir u Obliku Keksa SQ/M**

Šarnir srednje veličine u obliku keksa od sjajnog Inoxa Extracrome sa zaobljenim uglovima.

Kod	mm	MJ	€
0450060	V60 x D37+37	KOM	

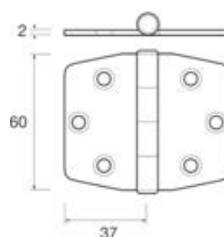
**Šarnir u Obliku Keksa SQ/L**

Veliki šarnir u obliku keksa od sjajnog Inoxa Extracrome sa zaobljenim uglovima.

Kod	mm	MJ	€
0450075	V75 x D37+37	KOM	

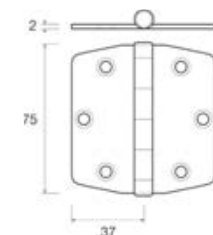
**Ovalni Šarniri Standard**

Ovalni šarniri od sjajnog Inoxa Extracrome.

Kod	mm	MJ	€
0456602	V35 x D51	KOM	
0456604	V48 x D67	KOM	
0456606	V56 x D78	KOM	

**Ovalni Šarniri Extra**

Ovalni šarniri od sjajnog Inoxa Extracrome.

Kod	Ref	mm	MJ	€
0456607	Big	V56 x D90	KOM	
0456610	Excenter	V56 x D84	KOM	
0456612	Long	V56 x D78	KOM	



Šarnir Wing S

Dvokrilni mali šarnir od sjajnog Inoxa Extracrome.

Kod	mm	MJ	€
0452210	V27 x D50+50	KOM	

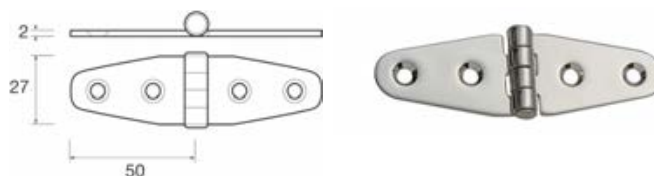
**Šarnir Wing M**

Dvokrilni šarnir srednje veličine od sjajnog Inoxa Extracrome.

Standard = Gornji zglobni klin

Centerpin = Središnji zglobni klin

Kod	Ref	mm	MJ	€
0452213	Standard	V39 x D70+70	KOM	
0452313	Centerpin	V39 x D70+70	KOM	

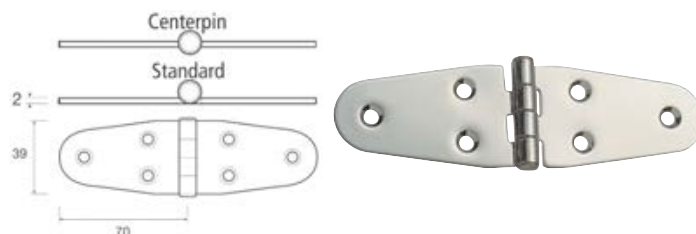
**Šarnir Wing L**

Dvokrilni veliki šarnir od sjajnog Inoxa Extracrome.

Kod	mm	MJ	€
0452218	V40 x D90+90	KOM	

**Ekscentrični Šarnir S**

Mali ekscentrični šarnir od sjajnog Inoxa Extracrome.

Standard = Gornji zglobni klin

Centerpin = Središnji zglobni klin

Kod	Ref	mm	MJ	€
0452508	Standard	V40 x D36+19	KOM	
0452708	Reverse	V40 x D37+22	KOM	

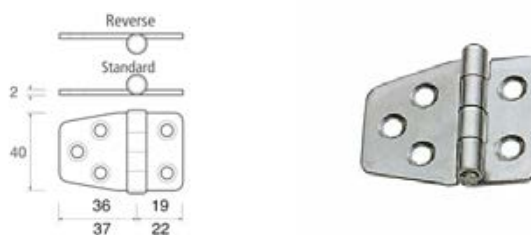
**Ekscentrični Šarnir M**

Ekscentrični šarnir srednje veličine od sjajnog Inoxa Extracrome.

Kod	mm	MJ	€
0452512	V39 x D70+30	KOM	

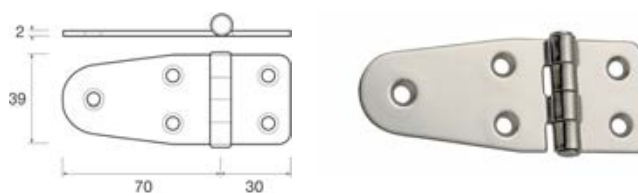
**Ekscentrični Šarnir R**

Zaobljeni ekscentrični šarnir srednje veličine od sjajnog Inoxa Extracrome.

Standard = Gornji zglobni klin

Centerpin = Središnji zglobni klin

Kod	Ref	mm	MJ	€
0452516	Standard	V39 x D70+37	KOM	
0452616	Centerpin	V39 x D70+37	KOM	

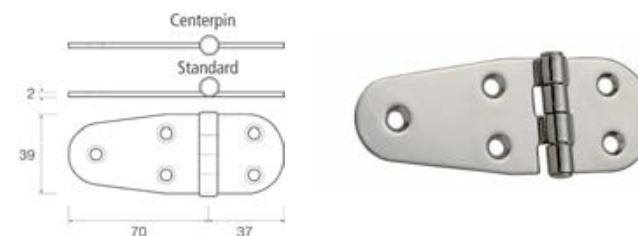
**Ekscentrični Šarnir L**

Veliki ekscentrični šarnir od sjajnog Inoxa Extracrome.

Kod	mm	MJ	€
0452519	V40 x D39+90	KOM	

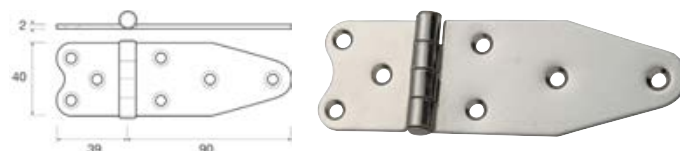

Šarnir Offset Mini

Mali izbočeni šarnir od Inoxa.

Kod	mm	MJ	€
0403535	V37,5 x D38	KOM	

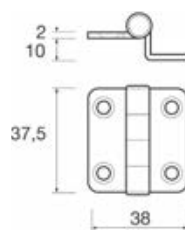
**Šarnir Offset Long**

Dugi izbočeni ekscentrični šarnir od Inoxa.

Kod	mm	H mm	MJ	€
0403560	V38 x D65	10	KOM	
0403561	V38 x D65	24	KOM	

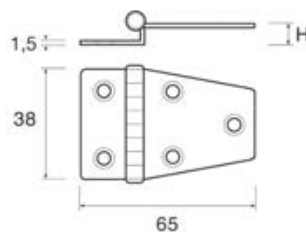
**Niski Šarnir Offset**

Nisko izbočeni šarnir od Inoxa za grotla i vratašča.

Kod	mm	MJ	€
0453524	V40 x D95+42	KOM	

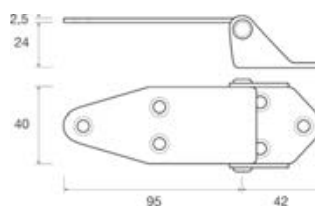
**Visoki Šarnir Offset**

Visoko izbočeni šarnir od Inoxa za grotla i vratašča.

Kod	mm	MJ	€
0453534	V40 x D95+42	KOM	

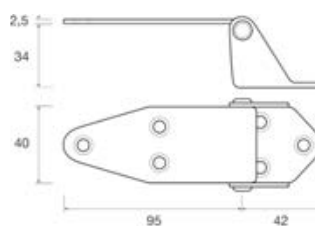
**Niski Štancani Šarnir Offset**

Nisko izbočeni šarnir od štancanog Inoxa za grotla i vratašča.

Kod	mm	MJ	€
0453620	V40 x D50+81	KOM	

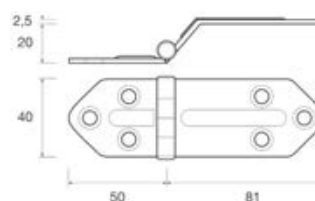
**Visoki Štancani Šarnir Offset**

Visoko izbočeni šarnir od štancanog Inoxa za grotla i vratašča.

Kod	mm	MJ	€
0453635	V40 x D50+81	KOM	

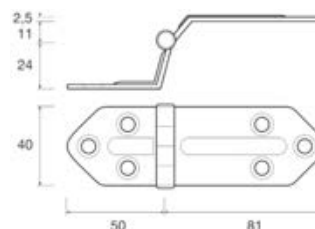
**Klasični Šarnir za Vratašča**

Klasični šarnir od sjajnog Inoxa AISI 316 s pokrivenom bazom. Za grotla i vratašča.

Kod	Dim mm	Dio na stijenci mm	Dio na vratima mm	MJ	€
0453000	57 x 30 x V10	26 x 30	30 x 30	KOM	



Ekscentrični Šarnir za Vratašča

Ekscentrični šarnir od sjajnog Inoxa AISI 316 za grotla i vratašča s visokim vratom.

Kod	mm	MJ	€
0453010	V43 x D33	KOM	

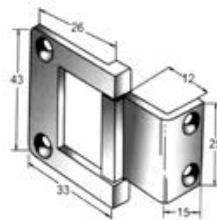
**Šarniri na Metar**

Šarniri od Inoxa u šipkama od 2 metra.

Kod	D mm	W mm	L m	MJ	€
0420025	0.8	25	2	KOM	
0420032	0.8	32	2	KOM	
0420040	0.8	40	2	KOM	

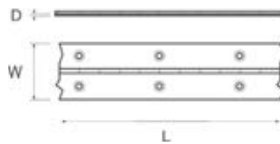
**- ŠARNIRI NA IZVLAČENJE OD INOXA EXTRACROME -****Ekscentrični Šarniri Offset**

Izbočeni ekscentrični šarnir od sjajnog Inoxa Extracrome na izvlačenje.

Kod	Smjer	mm	MJ	€
0455505	D	V37 x D48+18	KOM	
0455504	L	V37 x D48+18	KOM	

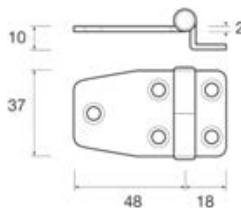
**Šarnir Offset Square S**

Šarnir od sjajnog Inoxa Extracrome s izvlačenjem na dvije razine. Omogućuje otvaranje vrata i vratašča s kutem otvaranja od 180°.

Kod	Smjer	mm	MJ	€
0456540	D	V40 x D19+16	KOM	
0456539	L	V40 x D19+16	KOM	

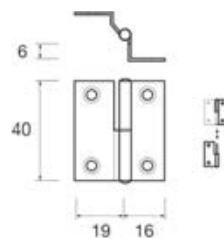
**Šarnir Offset Square L**

Šarnir od sjajnog Inoxa Extracrome s izvlačenjem na dvije razine. Omogućuje otvaranje vrata i vratašča s kutem otvaranja od 180°.

Kod	Smjer	mm	MJ	€
0456555	D	V55 x D19+16	KOM	
0456554	L	V55 x D19+16	KOM	

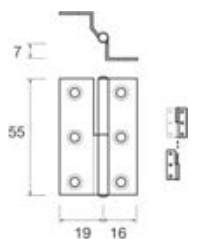
**Šarnir na Izvlačenje S**

Kompaktni šarnir na izvlačenje od sjajnog Inoxa Extracrome.

Kod	Smjer	mm	MJ	€
0455508	D	V85 x D37+19	KOM	
0455507	L	V85 x D37+19	KOM	

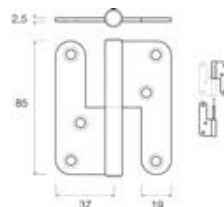
**Šarnir na Izvlačenje L**

Veliki šarnir na izvlačenje od sjajnog Inoxa Extracrome.

Kod	Smjer	mm	MJ	€
0455512	D	V110 x D49+25	KOM	
0455511	L	V110 x D49+25	KOM	

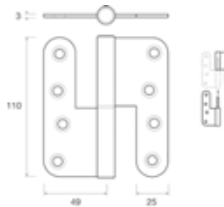

Čvrsti Pravokutni Šarnir M

Iznimno čvrsti pravokutni šarnir od sjajnog Inoxa Extracrome. Debljina 3 mm.

Kod	mm	MJ	€
0452902	V50 x D52	KOM	

**Čvrsti Šarnir u Obliku Kexsa S**

Iznimno čvrsti mali šarnir u obliku kexsa od sjajnog Inoxa Extracrome. Debljina 3 mm.

Kod	mm	MJ	€
0452904	V38 x D75	KOM	

**Čvrsti Šarnir u Obliku Kexsa M**

Iznimno čvrsti šarnir srednje veličine u obliku kexsa od sjajnog Inoxa Extracrome. Debljina 3 mm.

Kod	mm	MJ	€
0452910	V38 x D105	KOM	

**Čvrsti Ekscentrični Šarnir M**

Iznimno čvrsti ekscentrični šarnir srednje veličine od sjajnog Inoxa Extracrome. Debljina 3 mm.

Kod	mm	MJ	€
0452911	V38,5 x D67,2+41	KOM	

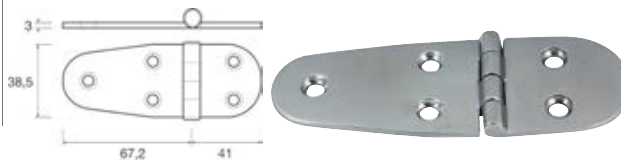
**Čvrsti Šarnir Wing M**

Iznimno čvrsti dvokrilni šarnir od sjajnog Inoxa Extracrome. Debljina 3 mm.

Kod	mm	MJ	€
0452914	V38 x D142	KOM	

**Čvrsti Šarnir Offset M**

Iznimno čvrsti izbočeni ekscentrični šarnir srednje veličine od sjajnog Inoxa Extracrome. Debljina 3 mm.

Kod	mm	MJ	€
0452923	V37,5 x D52,5+16	KOM	

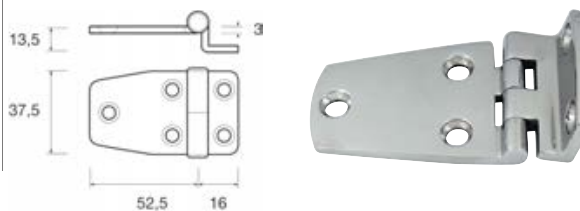
**Pokriveni Kvadratni Šarnir**

Pokriveni kvadratni šarnir od sjajnog Inoxa Extracrome.

Kod	mm	MJ	€
0452804	V36,5 x D35,7	KOM	

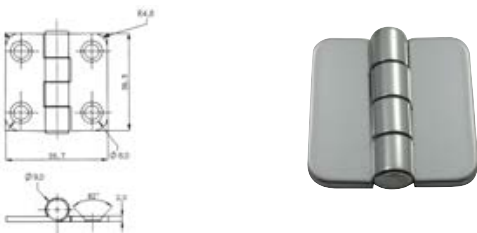
**Pokriveni Šarnir u Obliku Kexsa L**

Veliki pokriveni šarnir u obliku kexsa od sjajnog Inoxa Extracrome.

Kod	mm	MJ	€
0452817	V75 x D74	KOM	

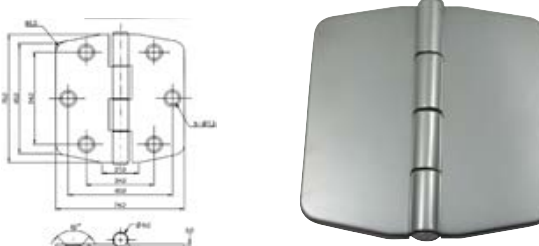
**Pokriveni Šarnir u Obliku Kexsa S**

Pokriveni šarnir u obliku kexsa od sjajnog Inoxa Extracrome.

Kod	mm	MJ	€
0452807	V36,5 x D76,2	KOM	

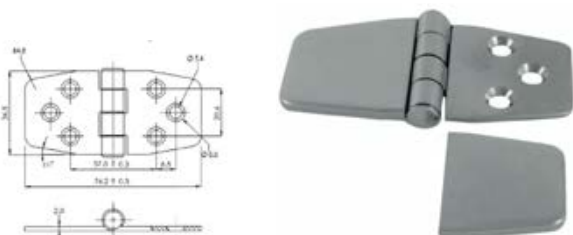
**Pokriveni Ekscentrični Šarnir S**

Pokriveni ekscentrični šarnir od sjajnog Inoxa Extracrome.

Kod	mm	MJ	€
0452808	V36,5 x D56,7	KOM	

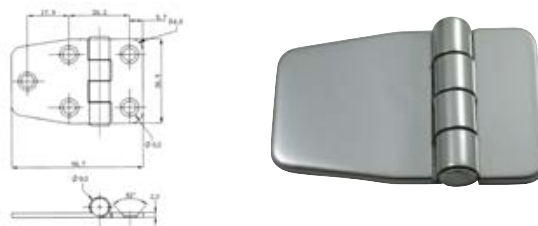

Šarnir u Ravnini Slim S

Šarnir u ravnini od sjajnog Inoxa Extracrome. Ugradnja s vijcima iznutra.

Kod	mm	MJ	€
0453018	70 x 35	KOM	

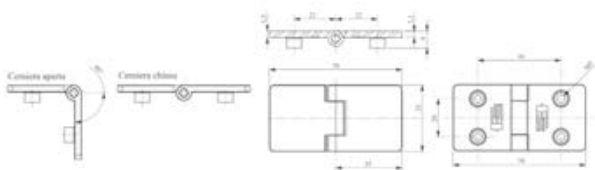
**Šarnir u Ravnini Slim M**

Šarnir u ravnini od sjajnog Inoxa Extracrome. Ugradnja s vijcima iznutra.

Kod	mm	MJ	€
0453011	70 x 65	KOM	

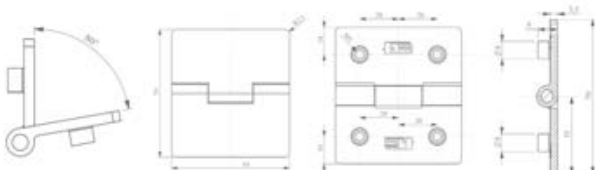
**Ekscentrični Šarnir u Ravnini Slim S**

Ekscentrični šarnir u ravnini od sjajnog Inoxa Extracrome. Ugradnja s vijcima izvana i iznutra.

Kod	mm	MJ	€
0453017	55 x 35	KOM	

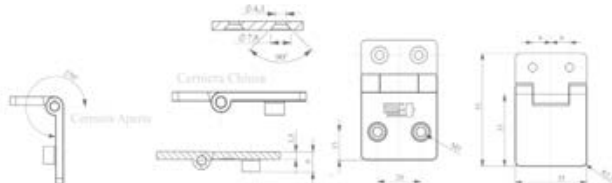
**Ekscentrični Šarnir u Ravnini Slim M**

Ekscentrični šarnir u ravnini od sjajnog Inoxa Extracrome. Ugradnja s vijcima izvana i iznutra.

Kod	mm	MJ	€
0453012	65 x 55	KOM	

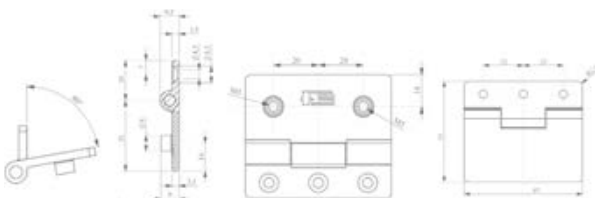
**Ekscentrični Šarnir u Ravnini M**

Ekscentrični šarnir u ravnini od sjajnog Inoxa Extracrome. Ugradnja s vijcima izvana i iznutra.

Kod	mm	MJ	€
0453014	70 x 30	KOM	

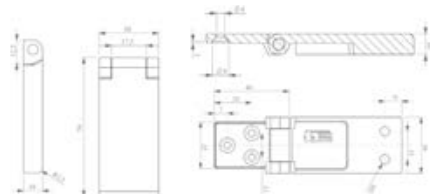
**Ekscentrični Šarnir u Ravnini S**

Ekscentrični šarnir u ravnini od sjajnog Inoxa Extracrome. Ugradnja s vijcima izvana i iznutra.

Kod	mm	MJ	€
0453013	45 x 30	KOM	

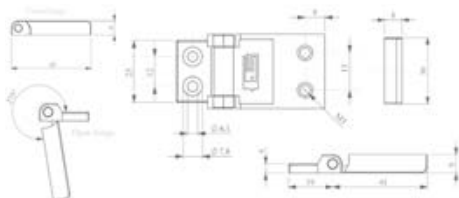

Klasični Šarnir na Izvlačenje

Klasični šarnir na izvlačenje od Kromiranog Mesinga s centralnom osovinom.

Kod	mm	Ref	MJ	€
0410006	60 x 50	D	KOM	
0410005	60 x 50	L	KOM	

**Niski Šarnir na Izvlačenje**

Niski šarnir na izvlačenje od Kromiranog Mesinga.

Kod	mm	Ref	MJ	€
0410010	100 x 30	D	KOM	
0410009	100 x 30	L	KOM	

**Šarnir Offset Standard**

Nisko izbočeni šarnir od Kromiranog Mesinga.

Kod	mm	V mm	MJ	€
0413509	96 x 59	10	KOM	

**Šarnir Offset Long**

Visoko izbočeni šarnir od Kromiranog Mesinga.

Kod	mm	V	MJ	€
0413513	135 x 58	40	KOM	

**Šarnir za Stepence**

Šarnir od Kromiranog Mesinga za preklopne stepence.

Kod	mm	MJ	€
0412514	145 x 20	KOM	

**Kuka i Ploča za Stepence**

Kuka i ploča od Kromiranog Mesinga za stepence.

Kod	Ref	MJ	€
0422515	Kuka za stepence	KOM	
0422516	Ploča za kuku	KOM	

**- ŠARNIRI OD OJAČANE PLASTIKE -****Šarnir u Obliku Keksa 40x63**

Šarnir u obliku kekisa od ojačane Plastike.

Kod	mm	Boja	MJ	€
0430006	40 x 63	CRNA	KOM	
0430026	40 x 63	BIJELA	KOM	

**Šarnir u Obliku Keksa 60x95**

Šarnir u obliku kekisa od ojačane Plastike.

Kod	mm	Boja	MJ	€
0430009	60 x 95	CRNA	KOM	
0430029	60 x 95	BIJELA	KOM	

**Ovalni Šarnir 40x70**

Ovalni šarnir od ojačane Plastike.

Kod	mm	Boja	MJ	€
0430007	40 x 70	CRNA	KOM	
0430027	40 x 70	BIJELA	KOM	

**Šarnir Wing 40x100**

Dvokrilni šarnir od ojačane Plastike.

Kod	mm	Boja	MJ	€
0430410	40 x 100	CRNA	KOM	
0430430	40 x 100	BIJELA	KOM	



Vijci sa Šesterokutnom Glavom DIN 933

Vijci sa šesterokutnom glavom DIN 933 od Inoxa A2.



Kod	mm	Kom / Pak	MJ	€
609330052010	5x20	100	PAK	
609330053010	5x30	100	PAK	
609330053505	5x35	50	PAK	
609330054005	5x40	50	PAK	
609330055005	5x50	50	PAK	
609330062005	6x20	50	PAK	
609330063005	6x30	50	PAK	
609330063505	6x35	50	PAK	
609330064005	6x40	50	PAK	
609330065005	6x50	50	PAK	
609330066005	6x60	50	PAK	
609330067002	6x70	20	PAK	
609330068002	6x80	20	PAK	
609330610002	6x100	20	PAK	
609330082005	8x20	50	PAK	
609330083005	8x30	50	PAK	
609330084005	8x40	50	PAK	
609330085005	8x50	50	PAK	
609330086002	8x60	20	PAK	
609330087002	8x70	20	PAK	
609330088002	8x80	20	PAK	
609330810001	8x100	10	PAK	
609330103002	10x30	20	PAK	
609330104002	10x40	20	PAK	
609330105002	10x50	20	PAK	
609330106002	10x60	20	PAK	
609330107002	10x70	20	PAK	
609330108002	10x80	20	PAK	
609331010001	10x100	10	PAK	
609330128001	12x80	10	PAK	
609331210001	12x100	10	PAK	
609331212001	12x120	10	PAK	

Vijci s Cilindričnom Glavom DIN 84

Vijci s cilindričnom glavom DIN 84 od Inoxa A2.



Kod	mm	Kom / Pak	MJ	€
600840031410	3x14	100	PAK	
600840032010	3x20	100	PAK	
600840032510	3x25	100	PAK	
600840033010	3x30	100	PAK	
600840042010	4x20	100	PAK	
600840042510	4x25	100	PAK	
600840043010	4x30	100	PAK	
600840043510	4x35	100	PAK	
600840044010	4x40	100	PAK	
600840045010	4x50	100	PAK	
600840052010	5x20	100	PAK	
600840052510	5x25	100	PAK	
600840053010	5x30	100	PAK	
600840053505	5x35	50	PAK	
600840054005	5x40	50	PAK	
600840055005	5x50	50	PAK	
600840056005	5x60	50	PAK	
600840062005	6x20	50	PAK	
600840063005	6x30	50	PAK	
600840064005	6x40	50	PAK	
600840065005	6x50	50	PAK	
600840066005	6x60	50	PAK	
600840068002	6x80	20	PAK	
600840610002	6x100	20	PAK	
600840083005	8x30	50	PAK	
600840084005	8x40	50	PAK	
600840085005	8x50	50	PAK	
600840086002	8x60	20	PAK	
600840088002	8x80	20	PAK	
600840810001	8x100	10	PAK	

Vijci s Upuštenom Ravnom Glavom DIN 963

Vijci s upuštenom ravnom glavom DIN 963 od Inoxa A2.



Kod	mm	Kom / Pak	MJ	€
609630031410	3x14	100	PAK	
609630032010	3x20	100	PAK	
609630032510	3x25	100	PAK	
609630033010	3x30	100	PAK	
609630042010	4x20	100	PAK	
609630042510	4x25	100	PAK	
609630043010	4x30	100	PAK	
609630043510	4x35	100	PAK	
609630044010	4x40	100	PAK	
609630045010	4x50	100	PAK	
609630052010	5x20	100	PAK	
609630052510	5x25	100	PAK	
609630053010	5x30	100	PAK	
609630053505	5x35	50	PAK	
609630054005	5x40	50	PAK	
609630055005	5x50	50	PAK	
609630056005	5x60	50	PAK	
609630062005	6x20	50	PAK	
609630063005	6x30	50	PAK	
609630064005	6x40	50	PAK	
609630065005	6x50	50	PAK	
609630066005	6x60	50	PAK	
609630068002	6x80	20	PAK	
609630610002	6x100	20	PAK	
609630083005	8x30	50	PAK	
609630084005	8x40	50	PAK	
609630085005	8x50	50	PAK	
609630086002	8x60	20	PAK	
609630088002	8x80	20	PAK	
609630810001	8x100	10	PAK	

Vijci s Upuštenom Lečastom Glavom DIN 964

Vijci s upuštenom lečastom glavom DIN 964 od Inoxa A2.



Kod	mm	Kom / Pak	MJ	€
609640031410	3x14	100	PAK	
609640032010	3x20	100	PAK	
609640032510	3x25	100	PAK	
609640033010	3x30	100	PAK	
609640042010	4x20	100	PAK	
609640042510	4x25	100	PAK	
609640043010	4x30	100	PAK	
609640043510	4x35	100	PAK	
609640044010	4x40	100	PAK	
609640045010	4x50	100	PAK	
609640052010	5x20	100	PAK	
609640052510	5x25	100	PAK	
609640053010	5x30	100	PAK	
609640053505	5x35	50	PAK	
609640054005	5x40	50	PAK	
609640055005	5x50	50	PAK	
609640056005	5x60	50	PAK	
609640062005	6x20	50	PAK	
609640063005	6x30	50	PAK	
609640064005	6x40	50	PAK	
609640065005	6x50	50	PAK	
609640066005	6x60	50	PAK	
609640068002	6x80	20	PAK	
609640610002	6x100	20	PAK	
609640083005	8x30	50	PAK	
609640084005	8x40	50	PAK	
609640085005	8x50	50	PAK	
609640086002	8x60	20	PAK	
609640088002	8x80	20	PAK	
609640810001	8x100	10	PAK	

Vijci Imbus sa Šesterokutnom Rupom DIN 912

Vijci imbus sa šesterokutnom rupom DIN 912 od Inoxa A2.



Kod	mm	Kom / Pak	MJ	€
609120052005	5x20	50	PAK	
609120052505	5x25	50	PAK	
609120053005	5x30	50	PAK	
609120053505	5x35	50	PAK	
609120054005	5x40	50	PAK	
609120055005	5x50	50	PAK	
609120056005	5x60	50	PAK	
609120062005	6x20	50	PAK	
609120062505	6x25	50	PAK	
609120063005	6x30	50	PAK	
609120064005	6x40	50	PAK	
609120065005	6x50	50	PAK	
609120066002	6x60	20	PAK	
609120068002	6x80	20	PAK	
609120610001	6x100	10	PAK	
609120082002	8x20	20	PAK	
609120083002	8x30	20	PAK	
609120084002	8x40	20	PAK	
609120085002	8x50	20	PAK	
609120086002	8x60	20	PAK	
609120088001	8x80	10	PAK	
609121010001	10x100	10	PAK	

Vijci sa Šesterokutnom Glavom i Djelomičnim Navojem DIN 931

Vijci sa šesterokutnom glavom od Inoxa A2.



Kod	mm	Kom / Pak	MJ	€
609310065002	6x50	20	PAK	
609310066002	6x60	20	PAK	
609310067002	6x70	20	PAK	
609310068002	6x80	20	PAK	
609310610001	6x100	10	PAK	
609310612001	6x120	10	PAK	
609310086001	8x60	10	PAK	
609310087001	8x70	10	PAK	
609310088001	8x80	10	PAK	
609310810001	8x100	10	PAK	
609310812001	8x120	10	PAK	
609310815001	8x150	10	PAK	
609310108001	10x80	10	PAK	
609311010001	10x100	10	PAK	
609311015001	10x150	10	PAK	
609311020001	10x200	10	PAK	
609310128001	12x80	10	PAK	
609311210001	12x100	10	PAK	
609311215001	12x150	10	PAK	
609311220001	12x200	10	PAK	

Šesterokutne Matice DIN 934

Šesterokutne matice DIN 934 od Inoxa A2.



Kod	mm	Kom / Pak	MJ	€
620093400310	M3	100	PAK	
620093400410	M4	100	PAK	
620093400510	M5	100	PAK	
620093400610	M6	100	PAK	
620093400810	M8	100	PAK	
620093401005	M10	50	PAK	
620093401205	M12	50	PAK	
620093401402	M14	20	PAK	
620093401602	M16	20	PAK	
620093401801	M18	10	PAK	

Samoblokirajuće Matice DIN 985

Samoblokirajuće matice DIN 985 od Inoxa A2.



Kod	mm	Kom / Pak	MJ	€
620098500405	M4	50	PAK	
620098500505	M5	50	PAK	
620098500605	M6	50	PAK	
620098500805	M8	50	PAK	
620098501005	M10	50	PAK	
620098501202	M12	20	PAK	
620098501401	M14	10	PAK	

Slijepe Lećaste Matice DIN 1587

Slijepe lećaste matice DIN 1587 od Inoxa A2.



Kod	mm	Kom / Pak	MJ	€
620158700405	M4	50	PAK	
620158700505	M5	50	PAK	
620158700605	M6	50	PAK	
620158700802	M8	20	PAK	
620158701002	M10	20	PAK	
620158701202	M12	20	PAK	
620158701401	M14	10	PAK	

Krilaste Matice DIN 315

Krilaste matice DIN 315 od Inoxa A2.



Kod	mm	Kom / Pak	MJ	€
620031500505	M5	50	PAK	
620031500605	M6	50	PAK	
620031500802	M8	20	PAK	
620031501002	M10	20	PAK	
620031501201	M12	10	PAK	

Ravne Podloške DIN 125

Ravne podloške DIN 125 od Inoxa A2.



Kod	mm	Kom / Pak	MJ	€
625011250310	D.3	100	PAK	
625011250410	D.4	100	PAK	
625011250510	D.5	100	PAK	
625011250610	D.6	100	PAK	
625011250810	D.8	100	PAK	
625011251010	D.10	100	PAK	
625011251205	D.12	50	PAK	
625011251405	D.14	50	PAK	
625011251602	D.16	20	PAK	
625011251802	D.18	20	PAK	

Ravne Podloške 3 Put Veće od Otvora

Ravne podloške 3 put veće od otvora od Inoxa A2.



Kod	mm	Kom / Pak	MJ	€
625000039010	3x9	100	PAK	
625000103005	10x30	50	PAK	
625000123602	12x36	20	PAK	
625000144202	14x42	20	PAK	
625000041210	4x12	100	PAK	
625000051510	5x15	100	PAK	
625000061810	6x18	100	PAK	
625000082410	8x24	100	PAK	

Podloške Grower DIN 127

Podloške Grower DIN 127 od Inoxa A2.



Kod	mm	Kom / Pak	MJ	€
625011270310	D.3	100	PAK	
625011270410	D.4	100	PAK	
625011270510	D.5	100	PAK	
625011270610	D.6	100	PAK	
625011270810	D.8	100	PAK	
625011271010	D.10	100	PAK	
625011271205	D.12	50	PAK	
625011271405	D.14	50	PAK	
625011271602	D.16	20	PAK	
625011271802	D.18	20	PAK	

Navojne Šipke od 1 Metra DIN 975

Navojne šipke od 1 metra DIN 975 od Inoxa A2.



Kod	mm	MJ	€
6300997504	M4	KOM	
6300997505	M5	KOM	
6300997506	M6	KOM	
6300997508	M8	KOM	
6300997510	M10	KOM	
6300997512	M12	KOM	
6300997514	M14	KOM	
6300997516	M16	KOM	
6300997518	M18	KOM	

Rascjepke DIN 94

Rascjepke DIN 94 od Inoxa A4.



Kod	mm	Kom / Pak	MJ	€
650094152010	1,5x20	100	PAK	
650094152510	1,5x25	100	PAK	
650094022010	2x20	100	PAK	
650094022510	2x25	100	PAK	
650094023010	2x30	100	PAK	
650094252010	2,5x20	100	PAK	
650094252510	2,5x25	100	PAK	
650094253010	2,5x30	100	PAK	
650094253510	2,5x35	100	PAK	
650094032010	3x20	100	PAK	
650094032510	3x25	100	PAK	
650094033010	3x30	100	PAK	
650094033510	3x35	100	PAK	
650094034010	3x40	100	PAK	
650094035010	3x50	100	PAK	
650094043010	4x30	100	PAK	
650094044005	4x40	50	PAK	
650094045005	4x50	50	PAK	
650094054005	5x40	50	PAK	
650094055005	5x50	50	PAK	
650094056005	5x60	50	PAK	
650094065005	6x50	50	PAK	
650094066005	6x60	50	PAK	

Slijepe Zakovice

Slijepe zakovice od Inoxa A2.



Kod	mm	Kom / Pak	MJ	€
6600000326	3,2 x 6	100	PAK	
6600000329	3,2 x 8	100	PAK	
66000003211	3,2 x 10	100	PAK	
66000003212	3,2 x 12	100	PAK	
6600000389	4 x 8	100	PAK	
66000003811	4 x 10	100	PAK	
66000003812	4 x 12	100	PAK	
66000003814	4 x 14	100	PAK	
66000003816	4 x 16	100	PAK	
6600000489	4,8 x 8	100	PAK	
66000004811	4,8 x 10	100	PAK	
66000004812	4,8 x 12	100	PAK	
66000004814	4,8 x 14	100	PAK	
66000004816	4,8 x 16	100	PAK	
66000004818	4,8 x 18	100	PAK	

Vijci s Upuštenom Ravnom Glavom DIN 7982

Vijci s upuštenom ravnom glavom DIN 7982 od Inoxa A2.



Kod	mm	Kom / Pak	MJ	€
607982290910	2,9x9,5	100	PAK	
607982291310	2,9x13	100	PAK	
607982291610	2,9x16	100	PAK	
607982291910	2,9x19	100	PAK	
607982292210	2,9x22	100	PAK	
607982351310	3,5x13	100	PAK	
607982351610	3,5x16	100	PAK	
607982351910	3,5x19	100	PAK	
607982352210	3,5x22	100	PAK	
607982352510	3,5x25	100	PAK	
607982353210	3,5x32	100	PAK	
607982353810	3,5x38	100	PAK	
607982391310	3,9x13	100	PAK	
607982391610	3,9x16	100	PAK	
607982391910	3,9x19	100	PAK	
607982392210	3,9x22	100	PAK	
607982392510	3,9x25	100	PAK	
607982393210	3,9x32	100	PAK	
607982393810	3,9x38	100	PAK	
607982421610	4,2x16	100	PAK	
607982421910	4,2x19	100	PAK	
607982422210	4,2x22	100	PAK	
607982422510	4,2x25	100	PAK	
607982423210	4,2x32	100	PAK	
607982423810	4,2x38	100	PAK	
607982425010	4,2x50	100	PAK	
607982481610	4,8x16	100	PAK	
607982481910	4,8x19	100	PAK	
607982482210	4,8x22	100	PAK	
607982482510	4,8x25	100	PAK	
607982483210	4,8x32	100	PAK	
607982483805	4,8x38	50	PAK	
607982485005	4,8x50	50	PAK	
607982551905	5,5x19	50	PAK	
607982552205	5,5x22	50	PAK	
607982553205	5,5x32	50	PAK	
607982553805	5,5x38	50	PAK	
607982555005	5,5x50	50	PAK	
607982556005	5,5x60	50	PAK	
607982632205	6,3x22	50	PAK	
607982632505	6,3x25	50	PAK	
607982633205	6,3x32	50	PAK	
607982633802	6,3x38	20	PAK	
607982635002	6,3x50	20	PAK	
607982636002	6,3x60	20	PAK	
607982637002	6,3x70	20	PAK	

Vijci s Upuštenom Lečastom Glavom DIN 7983

Vijci s upuštenom lečastom glavom DIN 7983 od Inoxa A2.



Kod	mm	Kom / Pak	MJ	€
607983290910	2,9x9,5	100	PAK	
607983291310	2,9x13	100	PAK	
607983291610	2,9x16	100	PAK	
607983291910	2,9x19	100	PAK	
607983292210	2,9x22	100	PAK	
607983351310	3,5x13	100	PAK	
607983351610	3,5x16	100	PAK	
607983351910	3,5x19	100	PAK	
607983352210	3,5x22	100	PAK	
607983352510	3,5x25	100	PAK	
607983353210	3,5x32	100	PAK	
607983353810	3,5x38	100	PAK	
607983391310	3,9x13	100	PAK	
607983391610	3,9x16	100	PAK	
607983391910	3,9x19	100	PAK	
607983392210	3,9x22	100	PAK	
607983392510	3,9x25	100	PAK	
607983393210	3,9x32	100	PAK	
607983393810	3,9x38	100	PAK	
607983421610	4,2x16	100	PAK	
607983421910	4,2x19	100	PAK	
607983422210	4,2x22	100	PAK	
607983422510	4,2x25	100	PAK	
607983423210	4,2x32	100	PAK	
607983423810	4,2x38	100	PAK	
607983425010	4,2x50	100	PAK	
607983481610	4,8x16	100	PAK	
607983481910	4,8x19	100	PAK	
607983482210	4,8x22	100	PAK	
607983482510	4,8x25	100	PAK	
607983483210	4,8x32	100	PAK	
607983483805	4,8x38	50	PAK	
607983485005	4,8x50	50	PAK	
607983551905	5,5x19	50	PAK	
607983552205	5,5x22	50	PAK	
607983553205	5,5x32	50	PAK	
607983553805	5,5x38	50	PAK	
607983555005	5,5x50	50	PAK	
607983556005	5,5x60	50	PAK	
607983632205	6,3x22	50	PAK	
607983632505	6,3x25	50	PAK	
607983633205	6,3x32	50	PAK	
607983633802	6,3x38	20	PAK	
607983635002	6,3x50	20	PAK	
607983636002	6,3x60	20	PAK	
607983637002	6,3x70	20	PAK	

Vijci s Cilindričnom Glavom DIN 7981

Vijci s cilindričnom glavom DIN 7981 od Inoxa A2.



Kod	mm	Kom / Pak	MJ	€
607981290910	2,9x9,5	100	PAK	
607981291310	2,9x13	100	PAK	
607981291610	2,9x16	100	PAK	
607981291910	2,9x19	100	PAK	
607981292210	2,9x22	100	PAK	
607981351310	3,5x13	100	PAK	
607981351610	3,5x16	100	PAK	
607981351910	3,5x19	100	PAK	
607981352210	3,5x22	100	PAK	
607981352510	3,5x25	100	PAK	
607981353210	3,5x32	100	PAK	
607981353810	3,5x38	100	PAK	
607981391310	3,9x13	100	PAK	
607981391610	3,9x16	100	PAK	
607981391910	3,9x19	100	PAK	
607981392210	3,9x22	100	PAK	
607981392510	3,9x25	100	PAK	
607981393210	3,9x32	100	PAK	
607981393810	3,9x38	100	PAK	
607981421610	4,2x16	100	PAK	
607981421910	4,2x19	100	PAK	
607981422210	4,2x22	100	PAK	
607981422510	4,2x25	100	PAK	
607981423210	4,2x32	100	PAK	
607981423810	4,2x38	100	PAK	
607981425010	4,2x50	100	PAK	
607981481610	4,8x16	100	PAK	
607981481910	4,8x19	100	PAK	
607981482210	4,8x22	100	PAK	
607981482510	4,8x25	100	PAK	
607981483210	4,8x32	100	PAK	
607981483805	4,8x38	50	PAK	
607981485005	4,8x50	50	PAK	
607981551905	5,5x19	50	PAK	
607981552205	5,5x22	50	PAK	
607981553205	5,5x32	50	PAK	
607981553805	5,5x38	50	PAK	
607981555005	5,5x50	50	PAK	
607981556005	5,5x60	50	PAK	
607981632205	6,3x22	50	PAK	
607981632505	6,3x25	50	PAK	
607981633205	6,3x32	50	PAK	
607981633802	6,3x38	20	PAK	
607981635002	6,3x50	20	PAK	
607981636002	6,3x60	20	PAK	
607981637002	6,3x70	20	PAK	

- VIJCI ZA DRVO -**Vijci za Drvene Ploče i Ivericu s Upuštenom Ravnom Glavom**

Vijci za drvene ploče i ivericu DIN 6112 od Inoxa A2.

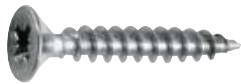

Kod	mm	Kom / Pak	MJ	€
606112301210	3x12	100	PAK	
606112301610	3x16	100	PAK	
606112302010	3x20	100	PAK	
606112302510	3x25	100	PAK	
606112303010	3x30	100	PAK	
606112303510	3x35	100	PAK	
606112351610	3,5x16	100	PAK	
606112352010	3,5x20	100	PAK	
606112352510	3,5x25	100	PAK	
606112353010	3,5x30	100	PAK	
606112353510	3,5x35	100	PAK	
606112354010	3,5x40	100	PAK	
606112402010	4x20	100	PAK	
606112402510	4x25	100	PAK	
606112403010	4x30	100	PAK	
606112403510	4x35	100	PAK	

Kod	mm	Kom / Pak	MJ	€
606112404010	4x40	100	PAK	
606112404510	4x45	100	PAK	
606112405010	4x50	100	PAK	
606112453010	4,5x30	100	PAK	
606112453510	4,5x35	100	PAK	
606112454010	4,5x40	100	PAK	
606112454510	4,5x45	100	PAK	
606112455010	4,5x50	100	PAK	
606112503010	5x30	100	PAK	
606112504010	5x40	100	PAK	
606112504505	5x45	50	PAK	
606112505005	5x50	50	PAK	
606112506005	5x60	50	PAK	
606112507005	5x70	50	PAK	
606112508005	5x80	50	PAK	
606112604005	6x40	50	PAK	
606112605005	6x50	50	PAK	
606112606005	6x60	50	PAK	
606112607002	6x70	20	PAK	
606112608002	6x80	20	PAK	
606112609002	6x90	20	PAK	
606112601002	6x100	20	PAK	

Vijci za Drvo sa Šesterokutnom Glavom DIN 571

Vijci za drvo sa šesterokutnom glavom DIN 571 od Inoxa A2.



Kod	mm	Kom / Pak	MJ	€
615710063002	6x30	20	PAK	
615710064002	6x40	20	PAK	
615710065002	6x50	20	PAK	
615710066002	6x60	20	PAK	
615710068002	6x80	20	PAK	
615710084002	8x40	20	PAK	
615710085002	8x50	20	PAK	
615710086002	8x60	20	PAK	
615710088002	8x80	20	PAK	
615710810001	8x100	10	PAK	
615710812001	8x120	10	PAK	
615710105002	10x50	20	PAK	
615710106002	10x60	20	PAK	
615710108002	10x80	20	PAK	
615711010001	10x100	10	PAK	

Vijci sa Šesterokutnom Glavom DIN 933

Vijci sa šesterokutnom glavom DIN 933 od Inoxa A4.



Kod	mm	Kom / Pak	MJ	€
709330052010	5x20	100	PAK	
709330053010	5x30	100	PAK	
709330054005	5x40	50	PAK	
709330055005	5x50	50	PAK	
709330062005	6x20	50	PAK	
709330063005	6x30	50	PAK	
709330064005	6x40	50	PAK	
709330065005	6x50	50	PAK	
709330066005	6x60	50	PAK	
709330068002	6x80	20	PAK	
709330610002	6x100	20	PAK	
709330083005	8x30	50	PAK	
709330084005	8x40	50	PAK	
709330085005	8x50	50	PAK	
709330086002	8x60	20	PAK	
709330088002	8x80	20	PAK	
709330810001	8x100	10	PAK	
709330104002	10x40	20	PAK	
709330105002	10x50	20	PAK	
709330106002	10x60	20	PAK	
709330108002	10x80	20	PAK	
709331010001	10x100	10	PAK	

Vijci s Upuštenom Ravnom Glavom DIN 963

Vijci s upuštenom ravnom glavom DIN 963 od Inoxa A4.



Kod	mm	Kom / Pak	MJ	€
709630032010	3x20	100	PAK	
709630032510	3x25	100	PAK	
709630033010	3x30	100	PAK	
709630042010	4x20	100	PAK	
709630042510	4x25	100	PAK	
709630043010	4x30	100	PAK	
709630044010	4x40	100	PAK	
709630045010	4x50	100	PAK	
709630052010	5x20	100	PAK	
709630053010	5x30	100	PAK	
709630054005	5x40	50	PAK	
709630055005	5x50	50	PAK	
709630056005	5x60	50	PAK	
709630063005	6x30	50	PAK	
709630064005	6x40	50	PAK	
709630065005	6x50	50	PAK	
709630066005	6x60	50	PAK	
709630068002	6x80	20	PAK	
709630610002	6x100	20	PAK	
709630083005	8x30	50	PAK	
709630084005	8x40	50	PAK	
709630085005	8x50	50	PAK	
709630086002	8x60	20	PAK	
709630088002	8x80	20	PAK	
709630810001	8x100	10	PAK	

- MATICE I PODLOŠKE -

Šesterokutne Matice DIN 934

Šesterokutne matice DIN 934 od Inoxa A4.



Kod	mm	Kom / Pak	MJ	€
720093400410	M4	100	PAK	
720093400510	M5	100	PAK	
720093400610	M6	100	PAK	
720093400810	M8	100	PAK	
720093401005	M10	50	PAK	

Samoblokirajuće Matice DIN 985

Samoblokirajuće matice DIN 985 od Inoxa A4.



Kod	mm	Kom / Pak	MJ	€
720098500405	M4	50	PAK	
720098500505	M5	50	PAK	
720098500605	M6	50	PAK	
720098500805	M8	50	PAK	
720098501005	M10	50	PAK	

- SAMONAREZNI VIJCI -

Vijci s Upuštenom Ravnom Glavom DIN 7982

Vijci s upuštenom ravnom glavom DIN 7982 od Inoxa A4.



Kod	mm	Kom / Pak	MJ	€
707982351310	3,5x13	100	PAK	
707982351610	3,5x16	100	PAK	
707982351910	3,5x19	100	PAK	
707982352210	3,5x22	100	PAK	
707982352510	3,5x25	100	PAK	
707982391310	3,9x13	100	PAK	
707982391610	3,9x16	100	PAK	
707982391910	3,9x19	100	PAK	
707982392210	3,9x22	100	PAK	
707982392510	3,9x25	100	PAK	
707982393210	3,9x32	100	PAK	
707982393810	3,9x38	100	PAK	
707982421610	4,2x16	100	PAK	
707982421910	4,2x19	100	PAK	
707982422210	4,2x22	100	PAK	
707982422510	4,2x25	100	PAK	
707982423210	4,2x32	100	PAK	
707982423810	4,2x38	100	PAK	
707982481610	4,8x16	100	PAK	
707982481910	4,8x19	100	PAK	
707982482210	4,8x22	100	PAK	
707982482510	4,8x25	100	PAK	
707982483210	4,8x32	100	PAK	
707982483805	4,8x38	50	PAK	
707982485005	4,8x50	50	PAK	
707982552205	5,5x22	50	PAK	
707982553205	5,5x32	50	PAK	
707982553805	5,5x38	50	PAK	
707982555005	5,5x50	50	PAK	
707982632505	6,3x25	50	PAK	
707982633205	6,3x32	50	PAK	
707982633802	6,3x38	20	PAK	
707982635002	6,3x50	20	PAK	
707982636002	6,3x60	20	PAK	

Vijci s Cilindričnom Glavom DIN 7981

Vijci s cilindričnom glavom DIN 7981 od Inoxa A4.



Kod	mm	Kom / Pak	MJ	€
707981351310	3,5x13	100	PAK	
707981351610	3,5x16	100	PAK	
707981351910	3,5x19	100	PAK	
707981352210	3,5x22	100	PAK	
707981352510	3,5x25	100	PAK	
707981391310	3,9x13	100	PAK	
707981391610	3,9x16	100	PAK	
707981391910	3,9x19	100	PAK	
707981392210	3,9x22	100	PAK	
707981392510	3,9x25	100	PAK	
707981393210	3,9x32	100	PAK	
707981393810	3,9x38	100	PAK	
707981421610	4,2x16	100	PAK	
707981421910	4,2x19	100	PAK	
707981422210	4,2x22	100	PAK	
707981422510	4,2x25	100	PAK	
707981423210	4,2x32	100	PAK	
707981423810	4,2x38	100	PAK	
707981481610	4,8x16	100	PAK	
707981481910	4,8x19	100	PAK	
707981482210	4,8x22	100	PAK	
707981482510	4,8x25	100	PAK	
707981483210	4,8x32	100	PAK	
707981483805	4,8x38	50	PAK	
707981485005	4,8x50	50	PAK	
707981552205	5,5x22	50	PAK	
707981553205	5,5x32	50	PAK	
707981553805	5,5x38	50	PAK	
707981555005	5,5x50	50	PAK	
707981632505	6,3x25	50	PAK	
707981633205	6,3x32	50	PAK	
707981633802	6,3x38	20	PAK	
707981635002	6,3x50	20	PAK	
707981636002	6,3x60	20	PAK	

Ravne Podloške DIN 125

Ravne podloške DIN 125 od Inoxa A4.



Kod	mm	Kom / Pak	MJ	€
725011250410	D.4	100	PAK	
725011250510	D.5	100	PAK	
725011250610	D.6	100	PAK	
725011250810	D.8	100	PAK	
725011251010	D.10	100	PAK	

Ravne Podloške 3 Put Veće od Otvora

Ravne podloške 3 put veće od otvora od Inoxa A4.



Kod	mm	Kom / Pak	MJ	€
725000041210	4x12	100	PAK	
725000051510	5x15	100	PAK	
725000061810	6x18	100	PAK	
725000082410	8x24	100	PAK	
725000103005	10x30	50	PAK	

Šesterokutne Matice DIN 934

Šesterokutne matice DIN 934 od Inoxa A4 u blister pakiranju.



Kod	mm	Kom / Pak	MJ	€
7934004	M4	15	PAK	
7934005	M5	15	PAK	
7934006	M6	10	PAK	
7934008	M8	5	PAK	
7934010	M10	4	PAK	

Šesterokutne Samoblokirajuće Matice DIN 985

Šesterokutne samoblokirajuće matice DIN 985 od Inoxa A4 u blister pakiranju.



Kod	mm	Kom / Pak	MJ	€
7985004	M4	6	PAK	
7985005	M5	6	PAK	
7985006	M6	4	PAK	
7985008	M8	4	PAK	
7985010	M10	2	PAK	

Ravne Podloške DIN 125

Ravne podloške DIN 125 od Inoxa A4 u blister pakiranju.



Kod	mm	Kom / Pak	MJ	€
7125004	D.4	20	PAK	
7125005	D.5	20	PAK	
7125006	D.6	20	PAK	
7125008	D.8	20	PAK	
7125010	D.10	10	PAK	

Ravne Podloške 3 Put Veće od Otvora DIN 9021

Ravne podloške 3 put veće od otvora DIN 9021 od Inoxa A4 u blister pakiranju.



Kod	mm	Kom / Pak	MJ	€
7902104	4x12	20	PAK	
7902105	5x15	20	PAK	
7902106	6x18	20	PAK	
7902108	8x24	10	PAK	
7902110	10x30	4	PAK	

Vijci s Cilindričnom Glavom DIN 7985

Vijci s cilindričnom glavom DIN 7985 od Inoxa A4 u blister pakiranju koji uključuje matice.



Kod	mm	Kom / Pak	MJ	€
798504020	4x20	8	PAK	
798504025	4x25	6	PAK	
798504030	4x30	6	PAK	
798504040	4x40	6	PAK	
798504050	4x50	6	PAK	
798505020	5x20	6	PAK	
798505030	5x30	6	PAK	
798505040	5x40	4	PAK	
798505050	5x50	4	PAK	
798506020	6x20	4	PAK	
798506025	6x25	4	PAK	
798506040	6x40	4	PAK	
798506050	6x50	4	PAK	
798506060	6x60	4	PAK	

Vijci sa Šesterokutnom Rupom DIN 912

Vijci sa šesterokutnom rupom i djelomičnim navojem DIN 912 od Inoxa A4 u blister pakiranju koji uključuje matice.



Kod	mm	Kom / Pak	MJ	€
791205020	5x20	6	PAK	
791205025	5x25	6	PAK	
791205030	5x30	6	PAK	
791205040	5x40	6	PAK	
791205050	5x50	4	PAK	
791205060	5x60	4	PAK	
791206020	6x20	4	PAK	
791206025	6x25	4	PAK	
791206030	6x30	4	PAK	
791206040	6x40	4	PAK	
791206050	6x50	4	PAK	
791206060	6x60	4	PAK	
791208030	8x30	2	PAK	
791208040	8x40	2	PAK	
791208050	8x50	2	PAK	
791208060	8x60	2	PAK	
791208080	8x80	2	PAK	
791208100	8x100	2	PAK	

Vijci s Upuštenom Ravnom Glavom DIN 965

Vijci s upuštenom ravnom glavom DIN 965 od Inoxa A4 u blister pakiranju koji uključuje matice.



Kod	mm	Kom / Pak	MJ	€
796504020	4x20	8	PAK	
796504025	4x25	6	PAK	
796504030	4x30	6	PAK	
796504040	4x40	6	PAK	
796504050	4x50	4	PAK	
796505020	5x20	6	PAK	
796505025	5x25	6	PAK	
796505030	5x30	6	PAK	
796505040	5x40	6	PAK	
796505050	5x50	4	PAK	
796505060	5x60	4	PAK	
796506020	6x20	4	PAK	
796506025	6x25	4	PAK	
796506030	6x30	4	PAK	
796506040	6x40	4	PAK	
796506050	6x50	4	PAK	
796506060	6x60	4	PAK	
796506070	6x70	4	PAK	
796506090	6x90	2	PAK	
796508030	8x30	4	PAK	
796508040	8x40	4	PAK	
796508050	8x50	2	PAK	
796508060	8x60	2	PAK	
796508080	8x80	2	PAK	

Vijci sa Šesterokutnom Glavom DIN 933

Vijci sa šesterokutnom glavom DIN 933 od Inoxa A4 u blister pakiranju koji uključuje matice.



Kod	mm	Kom / Pak	MJ	€
793305020	5x20	8	PAK	
793305025	5x25	6	PAK	
793305030	5x30	6	PAK	
793305040	5x40	6	PAK	
793305050	5x50	4	PAK	
793305060	5x60	4	PAK	
793306020	6x20	6	PAK	
793306025	6x25	6	PAK	
793306030	6x30	4	PAK	
793306040	6x40	4	PAK	
793306050	6x50	4	PAK	
793306060	6x60	4	PAK	
793306080	6x80	2	PAK	
793306100	6x100	2	PAK	
793308030	8x30	4	PAK	
793308040	8x40	4	PAK	
793308050	8x50	2	PAK	
793308060	8x60	2	PAK	
793308080	8x80	2	PAK	
793308100	8x100	2	PAK	
793310030	10x30	2	PAK	
793310040	10x40	2	PAK	
793310050	10x50	2	PAK	
793310060	10x60	2	PAK	
793310080	10x80	1	PAK	
793310100	10x100	1	PAK	

Samonarezni Vijci s Cilindričnom Glavom DIN 7981

Vijci s cilindričnom glavom DIN 7981 od Inoxa A4 u blister pakiranju.



Kod	mm	Kom / Pak	MJ	€
798129009	2,9x9,5	20	PAK	
798129013	2,9x13	20	PAK	
798129016	2,9x16	20	PAK	
798129019	2,9x19	20	PAK	
798135013	3,5x13	15	PAK	
798135016	3,5x16	12	PAK	
798135019	3,5x19	12	PAK	
798135025	3,5x25	12	PAK	
798139016	3,9x16	12	PAK	
798139019	3,9x19	12	PAK	
798139025	3,9x25	12	PAK	
798139032	3,9x32	10	PAK	
798139038	3,9x38	10	PAK	
798142016	4,2x16	12	PAK	
798142019	4,2x19	12	PAK	
798142025	4,2x25	10	PAK	
798142032	4,2x32	10	PAK	
798142038	4,2x38	6	PAK	
798148016	4,8x16	10	PAK	
798148019	4,8x19	10	PAK	
798148025	4,8x25	10	PAK	
798148032	4,8x32	6	PAK	
798148038	4,8x38	6	PAK	
798155019	5,5x19	6	PAK	
798155025	5,5x25	6	PAK	
798155032	5,5x32	6	PAK	
798155038	5,5x38	6	PAK	
798155050	5,5x50	4	PAK	
798163019	6,3x19	6	PAK	
798163025	6,3x25	6	PAK	
798163032	6,3x32	6	PAK	
798163038	6,3x38	6	PAK	
798163050	6,3x50	4	PAK	

Vijci za Drvo sa Šesterokutnom Glavom DIN 571

Vijci za drvo sa šesterokutnom glavom DIN 571 od Inoxa A4 u blister pakiranju.



Kod	mm	Kom / Pak	MJ	€
75716030	6x30	4	PAK	
75716040	6x40	4	PAK	
75716050	6x50	4	PAK	
75716060	6x60	4	PAK	
75718040	8x40	4	PAK	
75718060	8x60	2	PAK	
75718080	8x80	2	PAK	
75718100	8x100	2	PAK	

Samonarezni Vijci s Upuštenom Ravnom Glavom

Samonarezni vijci s upuštenom ravnom glavom DIN 7982 od Inoxa A4 u blister pakiranju.



Kod	mm	Kom / Pak	MJ	€
798229009	2,9x9,5	20	PAK	
798229013	2,9x13	20	PAK	
798229016	2,9x16	20	PAK	
798229019	2,9x19	20	PAK	
798235013	3,5x13	15	PAK	
798235016	3,5x16	12	PAK	
798235019	3,5x19	12	PAK	
798235025	3,5x25	12	PAK	
798239019	3,9x19	12	PAK	
798239025	3,9x25	12	PAK	
798239032	3,9x32	10	PAK	
798239038	3,9x38	10	PAK	
798242016	4,2x16	12	PAK	
798242019	4,2x19	12	PAK	
798242025	4,2x25	10	PAK	
798242032	4,2x32	10	PAK	
798242038	4,2x38	6	PAK	
798248016	4,8x16	10	PAK	
798248019	4,8x19	10	PAK	
798248025	4,8x25	10	PAK	
798248032	4,8x32	6	PAK	
798248038	4,8x38	6	PAK	
798255019	5,5x19	6	PAK	
798255025	5,5x25	6	PAK	
798255032	5,5x32	6	PAK	
798255038	5,5x38	6	PAK	
798255045	5,5x45	6	PAK	
798263025	6,3x25	6	PAK	
798263032	6,3x32	6	PAK	
798263038	6,3x38	6	PAK	
798263050	6,3x50	6	PAK	

Samonarezni Vijci s Upuštenom Lečastom Glavom

Samonarezni vijci s upuštenom glavom i kapicom DIN 7983 od Inoxa A4 u blister pakiranju.



Kod	mm	Kom / Pak	MJ	€
798329009	2,9x9,5	20	PAK	
798329013	2,9x13	20	PAK	
798329016	2,9x16	20	PAK	
798329019	2,9x19	15	PAK	
798335013	3,5x13	15	PAK	
798335016	3,5x16	12	PAK	
798335019	3,5x19	12	PAK	
798335025	3,5x25	12	PAK	
798339016	3,9x16	12	PAK	
798339019	3,9x19	12	PAK	
798339025	3,9x25	12	PAK	
798342016	4,2x16	12	PAK	
798342019	4,2x19	12	PAK	
798342025	4,2x25	10	PAK	
798342032	4,2x32	10	PAK	
798342038	4,2x38	6	PAK	
798348016	4,8x16	10	PAK	
798348019	4,8x19	10	PAK	
798348025	4,8x25	10	PAK	
798348032	4,8x32	6	PAK	
798348038	4,8x38	6	PAK	
798355019	5,5x19	6	PAK	
798355025	5,5x25	6	PAK	
798355032	5,5x32	6	PAK	
798355038	5,5x38	6	PAK	
798355050	5,5x50	4	PAK	
798363019	6,3x19	6	PAK	
798363025	6,3x25	6	PAK	
798363038	6,3x38	6	PAK	
798363050	6,3x50	4	PAK	

Vijci za Drvene Ploče i Ivericu s Upuštenom Ravnom Glavom DIN 6112

Vijci za drvene ploče i ivericu s upuštenom ravnom glavom DIN 6112 od Inoxa A4 u blister pakiranju.



Kod	mm	Kom / Pak	MJ	€
761123016	3x16	10	PAK	
761123020	3x20	10	PAK	
761123025	3x25	8	PAK	
761123030	3x30	8	PAK	
761123516	3,5x16	8	PAK	
761123520	3,5x20	8	PAK	
761123530	3,5x30	8	PAK	
761123540	3,5x40	8	PAK	
761124020	4x20	8	PAK	
761124030	4x30	8	PAK	
761124040	4x40	6	PAK	
761124050	4x50	4	PAK	
761125030	5x30	4	PAK	
761125040	5x40	4	PAK	
761125050	5x50	4	PAK	
761125060	5x60	2	PAK	
761126040	6x40	2	PAK	
761126050	6x50	2	PAK	
761126060	6x60	2	PAK	
761126080	6x80	2	PAK	