

2

FERRAMENTA /
CHIUSURE /
VITERIA

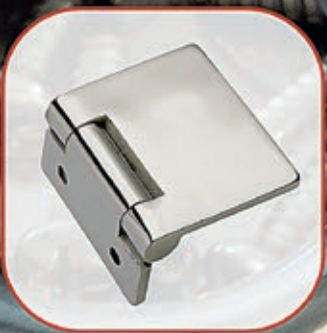

MTM

Grillo Dritto

Grillo Dritto in Acciaio Inox AISI 316.

| Cod. | D mm | L mm | W mm | UM | € |
|---------|------|------|------|----|---|
| 0120004 | 4 | 16 | 8 | PZ | |
| 0120005 | 5 | 20 | 10 | PZ | |
| 0120006 | 6 | 24 | 12 | PZ | |
| 0120008 | 8 | 32 | 16 | PZ | |
| 0120010 | 10 | 40 | 20 | PZ | |
| 0120012 | 12 | 48 | 24 | PZ | |
| 0120014 | 14 | 56 | 28 | PZ | |
| 0120016 | 16 | 64 | 32 | PZ | |

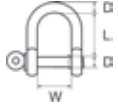
**Grillo Dritto Asse Imperdibile**

Grillo Dritto in Acciaio Inox AISI 316 con asse imperdibile.

| Cod. | D mm | L mm | W mm | UM | € |
|---------|------|------|------|----|---|
| 0120104 | 4 | 16 | 8 | PZ | |
| 0120105 | 5 | 20 | 10 | PZ | |
| 0120106 | 6 | 24 | 12 | PZ | |
| 0120108 | 8 | 32 | 16 | PZ | |
| 0120110 | 10 | 40 | 20 | PZ | |

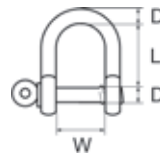
**Grillo Omega**

Grillo Omega in Acciaio Inox AISI 316.

| Cod. | D mm | L mm | W mm | UM | € |
|---------|------|------|------|----|---|
| 0120505 | 5 | 16 | 9 | PZ | |
| 0120506 | 6 | 21 | 12 | PZ | |
| 0120508 | 8 | 27 | 16 | PZ | |
| 0120510 | 10 | 33 | 20 | PZ | |
| 0120512 | 12 | 40 | 23 | PZ | |
| 0120514 | 14 | 51 | 27 | PZ | |
| 0120516 | 16 | 60 | 32 | PZ | |

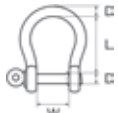
**Grillo Omega Asse Imperdibile**

Grillo Omega in Acciaio Inox AISI 316 con asse imperdibile.

| Cod. | D mm | L mm | W mm | UM | € |
|---------|------|------|------|----|---|
| 0120545 | 5 | 25 | 10 | PZ | |
| 0120546 | 6 | 30 | 12 | PZ | |
| 0120548 | 8 | 40 | 16 | PZ | |
| 0120550 | 10 | 50 | 20 | PZ | |

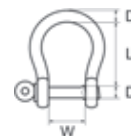
**Grillo Lungo**

Grillo Lungo in Acciaio Inox AISI 316.

| Cod. | D mm | L mm | W mm | UM | € |
|---------|------|------|------|----|---|
| 0120804 | 4 | 32 | 8 | PZ | |
| 0120805 | 5 | 40 | 10 | PZ | |
| 0120806 | 6 | 48 | 12 | PZ | |
| 0120808 | 8 | 64 | 16 | PZ | |
| 0120810 | 10 | 80 | 20 | PZ | |

**Grillo Lungo Asse Imperdibile**

Grillo Lungo in Acciaio Inox AISI 316 con asse imperdibile.

| Cod. | D mm | L mm | W mm | UM | € |
|---------|------|------|------|----|---|
| 0120704 | 4 | 32 | 8 | PZ | |
| 0120705 | 5 | 40 | 10 | PZ | |
| 0120706 | 6 | 48 | 12 | PZ | |
| 0120708 | 8 | 64 | 16 | PZ | |

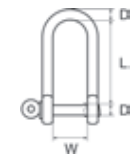
**Grillo Largo**

Grillo Largo in Acciaio Inox AISI 316.

| Cod. | D mm | L mm | W mm | UM | € |
|---------|------|------|------|----|---|
| 0121106 | 6 | 36 | 24 | PZ | |
| 0121108 | 8 | 36 | 28 | PZ | |
| 0121110 | 10 | 60 | 40 | PZ | |
| 0121112 | 12 | 72 | 48 | PZ | |

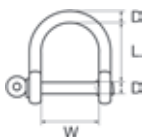
**Grillo Torto**

Grillo Torto in Acciaio Inox AISI 316.

| Cod. | D mm | L mm | W mm | UM | € |
|---------|------|------|------|----|---|
| 0121005 | 5 | 30 | 10 | PZ | |
| 0121006 | 6 | 36 | 12 | PZ | |
| 0121008 | 8 | 40 | 16 | PZ | |
| 0121010 | 10 | 50 | 20 | PZ | |

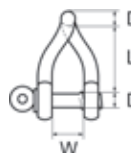
**Grillo Lungo Key Pin**

Grillo Lungo in Acciaio Inox AISI 316 a scatto con asse imperdibile.

| Cod. | D mm | L mm | W mm | UM | € |
|---------|------|------|------|----|---|
| 0120905 | 5 | 40 | 13 | PZ | |
| 0120906 | 6 | 45 | 16 | PZ | |
| 0120908 | 8 | 64 | 22 | PZ | |

**Grillo Lungo Key Pin B**

Grillo Lungo in Acciaio Inox AISI 316 con asse imperdibile e barretta.

| Cod. | D mm | L mm | W mm | UM | € |
|---------|------|------|------|----|---|
| 0120915 | 5 | 40 | 13 | PZ | |
| 0120916 | 6 | 45 | 16 | PZ | |
| 0120918 | 8 | 64 | 22 | PZ | |



Grillo Dritto Wichard

Grillo Dritto Wichard in Acciaio Inox AISI 316 con asse autobloccante. Testato e garantito nel carico di rottura (BL).

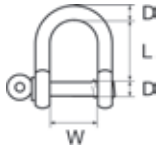

| Cod. | D mm | L mm | W mm | BL Kg | UM | € |
|---------|------|------|------|-------|----|---|
| 3521004 | 4 | 13 | 8 | 700 | PZ | |
| 3521005 | 5 | 16 | 10 | 1000 | PZ | |
| 3521006 | 6 | 20 | 12 | 1600 | PZ | |
| 3521008 | 8 | 26 | 16 | 2700 | PZ | |
| 3521010 | 10 | 33 | 20 | 4300 | PZ | |
| 3521012 | 12 | 39 | 24 | 6000 | PZ | |

**Grillo Dritto Asse Imperdibile Wichard**

Grillo Wichard Standard in Acciaio Inox AISI 316 con asse imperdibile autobloccante. Testato e garantito nel carico di rottura (BL).

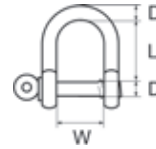

| Cod. | D mm | L mm | W mm | BL Kg | UM | € |
|---------|------|------|------|-------|----|---|
| 3521024 | 4 | 13 | 8 | 1000 | PZ | |
| 3521025 | 5 | 16 | 10 | 1500 | PZ | |
| 3521026 | 6 | 20 | 12 | 2200 | PZ | |
| 3521028 | 8 | 26 | 16 | 3600 | PZ | |
| 3521030 | 10 | 33 | 20 | 5200 | PZ | |

**Grillo Omega Wichard**

Grillo Wichard Omega in Acciaio Inox AISI 316 con asse autobloccante. Testato e garantito nel carico di rottura (BL).

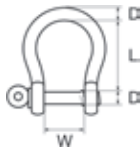

| Cod. | D mm | L mm | W mm | BL Kg | UM | € |
|---------|------|------|------|-------|----|---|
| 3521204 | 4 | 18 | 8 | 700 | PZ | |
| 3521205 | 5 | 23 | 10 | 1000 | PZ | |
| 3521206 | 6 | 28 | 12 | 1600 | PZ | |
| 3521208 | 8 | 37 | 16 | 2700 | PZ | |
| 3521210 | 10 | 47 | 20 | 4300 | PZ | |
| 3521212 | 12 | 55 | 24 | 6000 | PZ | |

**Grillo Omega Asse Imperdibile Wichard**

Grillo Wichard Omega in Acciaio Inox AISI 316 con asse imperdibile autobloccante. Testato e garantito nel carico di rottura (BL).

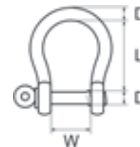

| Cod. | D mm | L mm | W mm | BL Kg | UM | € |
|---------|------|------|------|-------|----|---|
| 3521224 | 4 | 18 | 8 | 1000 | PZ | |
| 3521225 | 5 | 23 | 10 | 1500 | PZ | |
| 3521226 | 6 | 28 | 12 | 2200 | PZ | |
| 3521228 | 8 | 37 | 16 | 3700 | PZ | |
| 3521230 | 10 | 47 | 20 | 5200 | PZ | |

**Grillo Lungo Wichard**

Grillo Wichard Lungo in Acciaio Inox AISI 316 con asse autobloccante. Testato e garantito nel carico di rottura (BL).

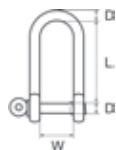

| Cod. | D mm | L mm | W mm | BL Kg | UM | € |
|---------|------|------|------|-------|----|---|
| 3521104 | 4 | 22 | 8 | 700 | PZ | |
| 3521105 | 5 | 29 | 10 | 1000 | PZ | |
| 3521106 | 6 | 33 | 12 | 1600 | PZ | |
| 3521108 | 8 | 45 | 16 | 2700 | PZ | |
| 3521110 | 10 | 55 | 20 | 4300 | PZ | |

**Grillo Lungo Asse Imperdibile Wichard**

Grillo Wichard Lungo in Acciaio Inox AISI 316 con asse imperdibile autobloccante. Testato e garantito nel carico di rottura (BL).



| Cod. | D mm | L mm | W mm | BL Kg | UM | € |
|---------|------|------|------|-------|----|---|
| 3521124 | 4 | 31 | 8 | 1000 | PZ | |
| 3521125 | 5 | 39 | 10 | 1500 | PZ | |
| 3521126 | 6 | 46 | 12 | 2200 | PZ | |
| 3521128 | 8 | 62 | 16 | 3600 | PZ | |

**Grillo Torto Wichard**

Grillo Wichard Torto in Acciaio Inox AISI 316 con asse autobloccante. Testato e garantito nel carico di rottura (BL).

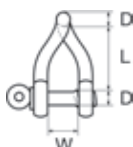

| Cod. | D mm | L mm | W mm | BL Kg | UM | € |
|---------|------|------|------|-------|----|---|
| 3521305 | 5 | 26 | 10 | 1100 | PZ | |
| 3521306 | 6 | 30 | 12 | 1500 | PZ | |
| 3521308 | 8 | 40 | 16 | 3000 | PZ | |

**Grillo Torto Asse Imperdibile Wichard**

Grillo Wichard Torto in Acciaio Inox AISI 316 con asse imperdibile autobloccante. Testato e garantito nel carico di rottura (BL).



| Cod. | D mm | L mm | W mm | BL Kg | UM | € |
|---------|------|------|------|-------|----|---|
| 3521325 | 5 | 38 | 10 | 1500 | PZ | |
| 3521326 | 6 | 44 | 12 | 2100 | PZ | |
| 3521328 | 8 | 59 | 16 | 3700 | PZ | |

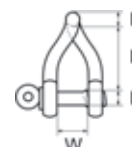

Grillo Dritto MTM

Grillo Dritto in Acciaio Inox 316 di qualità superiore fornito su Card da esposizione. Carico di lavoro (WL) testato e garantito. Il carico di rottura (BL) è 4 volte il carico di lavoro.

| Cod. | D mm | L mm | W mm | WL Kg | BL Kg | UM | € |
|----------|------|------|------|-------|-------|----|---|
| 0120005C | 5 | 20 | 10 | 230 | 920 | PZ | |
| 0120006C | 6 | 24 | 12 | 330 | 1320 | PZ | |
| 0120008C | 8 | 32 | 16 | 600 | 2400 | PZ | |
| 0120010C | 10 | 40 | 20 | 930 | 3720 | PZ | |
| 0120012C | 12 | 48 | 24 | 1400 | 5600 | PZ | |
| 0120014C | 14 | 56 | 28 | 1800 | 7200 | PZ | |

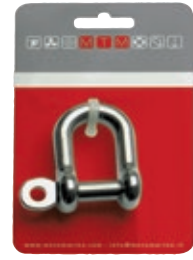
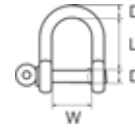

MTM

Grillo Omega MTM

Grillo Omega in Acciaio Inox 316 di qualità superiore fornito su Card da esposizione. Carico di lavoro (WL) testato e garantito. Il carico di rottura (BL) è 4 volte il carico di lavoro.

| Cod. | D mm | L mm | W mm | WL Kg | BL Kg | UM | € |
|----------|------|------|------|-------|-------|----|---|
| 0120506C | 6 | 21 | 12 | 330 | 1320 | PZ | |
| 0120508C | 8 | 27 | 16 | 590 | 2370 | PZ | |
| 0120510C | 10 | 33 | 20 | 930 | 3720 | PZ | |
| 0120512C | 12 | 40 | 23 | 1370 | 5490 | PZ | |
| 0120514C | 14 | 51 | 27 | 1800 | 7200 | PZ | |
| 0120516C | 16 | 60 | 32 | 2440 | 9760 | PZ | |

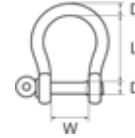

MTM

Grillo Lungo MTM

Grillo Lungo in Acciaio Inox 316 di qualità superiore fornito su Card da esposizione. Carico di lavoro (WL) testato e garantito. Il carico di rottura (BL) è 4 volte il carico di lavoro.

| Cod. | D mm | L mm | W mm | WL Kg | BL Kg | UM | € |
|----------|------|------|------|-------|-------|----|---|
| 0120805C | 5 | 40 | 10 | 230 | 920 | PZ | |
| 0120806C | 6 | 48 | 12 | 330 | 1320 | PZ | |
| 0120808C | 8 | 64 | 16 | 600 | 2400 | PZ | |
| 0120810C | 10 | 80 | 20 | 930 | 3720 | PZ | |

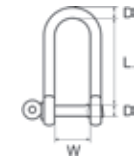

MTM

Grillo Torto MTM

Grillo Torto in Acciaio Inox 316 di qualità superiore fornito su Card da esposizione. Carico di lavoro (WL) testato e garantito. Il carico di rottura (BL) è 4 volte il carico di lavoro.

| Cod. | D mm | L mm | W mm | WL Kg | BL Kg | UM | € |
|----------|------|------|------|-------|-------|----|---|
| 0121005C | 5 | 30 | 10 | 230 | 920 | PZ | |
| 0121006C | 6 | 36 | 12 | 330 | 1320 | PZ | |
| 0121008C | 8 | 40 | 16 | 600 | 2400 | PZ | |
| 0121010C | 10 | 50 | 20 | 930 | 3720 | PZ | |

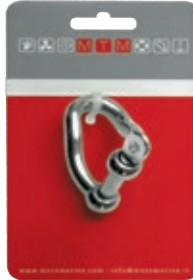
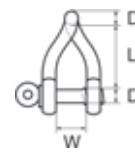

MTM

Grillo Largo MTM

Grillo Largo in Acciaio Inox 316 di qualità superiore fornito su Card da esposizione. Carico di lavoro (WL) testato e garantito. Il carico di rottura (BL) è 4 volte il carico di lavoro.

| Cod. | D mm | L mm | W mm | WL Kg | BL Kg | UM | € |
|----------|------|------|------|-------|-------|----|---|
| 0121106C | 6 | 36 | 24 | 330 | 1320 | PZ | |
| 0121108C | 8 | 36 | 28 | 600 | 2400 | PZ | |
| 0121110C | 10 | 60 | 40 | 930 | 3720 | PZ | |
| 0121112C | 12 | 72 | 48 | 1400 | 5600 | PZ | |

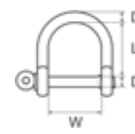

MTM

Grillo Lungo Key Pin MTM

Grillo Lungo a scatto con perno imperdibile in Acciaio Inox 316 di qualità superiore fornito su Card da esposizione. Carico di lavoro (WL) testato e garantito. Il carico di rottura (BL) è 4 volte il carico di lavoro.

| Cod. | D mm | L mm | W mm | WL Kg | BL Kg | UM | € |
|----------|------|------|------|-------|-------|----|---|
| 0120905C | 5 | 40 | 13 | 230 | 920 | PZ | |
| 0120906C | 6 | 45 | 16 | 330 | 1320 | PZ | |
| 0120908C | 8 | 64 | 22 | 600 | 2400 | PZ | |

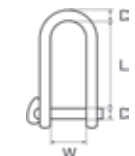

MTM

Grillo Lungo Key Pin B MTM

Grillo lungo a scatto con barretta in Acciaio Inox 316 di qualità superiore fornito su Card da esposizione. Carico di lavoro (WL) testato e garantito. Il carico di rottura (BL) è 4 volte il carico di lavoro.

| Cod. | D mm | L mm | W mm | WL Kg | BL Kg | UM | € |
|----------|------|------|------|-------|-------|----|---|
| 0120915C | 5 | 40 | 13 | 230 | 920 | PZ | |
| 0120916C | 6 | 45 | 16 | 330 | 1320 | PZ | |
| 0120918C | 8 | 64 | 22 | 600 | 2400 | PZ | |

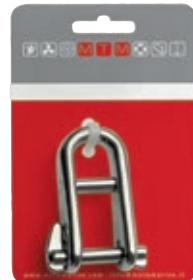
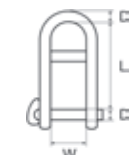

MTM

Grillo Dritto Stampato

Grillo Dritto in Acciaio Inox AISI 316 stampato.



| Cod. | D mm | L mm | W mm | UM | € |
|---------|------|------|------|----|---|
| 0121515 | 4 | 15 | 10 | PZ | |
| 0121517 | 5 | 17 | 12 | PZ | |
| 0121524 | 4 | 20 | 10 | PZ | |
| 0121525 | 5 | 24 | 16 | PZ | |
| 0121526 | 5 | 25 | 13,5 | PZ | |
| 0121542 | 6 | 23 | 16 | PZ | |

**Grillo Lungo Stampato**

Grillo Dritto in Acciaio Inox AISI 316 stampato.



| Cod. | D mm | L mm | W mm | UM | € |
|---------|------|------|------|----|---|
| 0121540 | 5 | 36 | 16 | PZ | |
| 0121543 | 6 | 40 | 14 | PZ | |
| 0121544 | 8 | 42 | 18 | PZ | |

**Grillo Torto**

Grillo Torto in Acciaio Inox AISI 316 stampato.

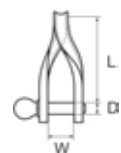

| Cod. | D mm | L mm | W mm | UM | € |
|---------|------|------|------|----|---|
| 0121552 | 5 | 22 | 12 | PZ | |
| 0121557 | 6 | 36 | 14 | PZ | |

**Grillo Dritto HS Stretto**

Grillo Dritto HS stretto in Acciaio Inox AISI 316 stampato. Testati nel carico di lavoro (WL). Il carico di rottura (BL) è 4 volte il carico di lavoro.



| Cod. | D mm | L mm | W mm | WL Kg | UM | € |
|---------|------|------|------|-------|----|---|
| 0121614 | 4 | 16 | 8 | 150 | PZ | |
| 0121615 | 5 | 20 | 8 | 250 | PZ | |
| 0121616 | 5 | 22 | 12 | 275 | PZ | |
| 0121617 | 6 | 25 | 13 | 325 | PZ | |

**Grillo Dritto HS Largo**

Grillo Dritto HS largo in Acciaio Inox AISI 316 stampato. Testati nel carico di lavoro (WL). Il carico di rottura (BL) è 4 volte il carico di lavoro.



| Cod. | D mm | L mm | W mm | WL Kg | UM | € |
|---------|------|------|------|-------|----|---|
| 0121624 | 4 | 20 | 10 | 150 | PZ | |
| 0121626 | 5 | 22 | 15 | 275 | PZ | |
| 0121627 | 6 | 25 | 17 | 325 | PZ | |

**Grillo Dritto Key Pin**

Grillo Dritto a scatto in Acciaio Inox AISI 316 stampato.

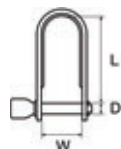

| Cod. | D mm | L mm | W mm | UM | € |
|---------|------|------|------|----|---|
| 0121562 | 4 | 22 | 11 | PZ | |
| 0121563 | 5 | 36 | 15 | PZ | |
| 0121564 | 6 | 40 | 15 | PZ | |

**Grillo Dritto Key Pin B**

Grillo Dritto a scatto in Acciaio Inox AISI 316 stampato con barretta.



| Cod. | D mm | L mm | L1 mm | W mm | UM | € |
|---------|------|------|-------|------|----|---|
| 0121573 | 5 | 21 | 12 | 15 | PZ | |
| 0121574 | 6 | 25 | 12 | 15 | PZ | |
| 0121575 | 8 | 26 | 12 | 20 | PZ | |

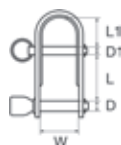

Moschettone Girevole Standard

Moschettone in Acciaio Inox AISI 316 con occhio girevole.

| Cod. | L mm | O mm | UM | € |
|---------|------|------|----|---|
| 0211565 | 68 | 13 | PZ | |
| 0211585 | 85 | 18 | PZ | |

**Moschettone Girevole Standard Bolt**

Moschettone in Acciaio Inox AISI 316 con occhiello girevole. Apertura a pistone.

| Cod. | L mm | O mm | UM | € |
|---------|------|------|----|---|
| 0211506 | 64 | 10 | PZ | |
| 0211508 | 80 | 13 | PZ | |

**Moschettone Girevole Square Bolt**

Moschettone in Acciaio Inox AISI 316 con occhiello girevole passacinghia. Apertura a pistone.

| Cod. | L mm | O mm | UM | € |
|---------|------|------|----|---|
| 0211516 | 61 | 13 | PZ | |
| 0211518 | 81 | 21 | PZ | |

**Moschettone Fisso Standard**

Moschettone in Acciaio Inox AISI 316 con occhio fisso.

| Cod. | L mm | O mm | UM | € |
|---------|------|------|----|---|
| 0211453 | 53 | 10 | PZ | |
| 0211473 | 73 | 16 | PZ | |

**Moschettone con Passacinghia**

Moschettone in Acciaio Inox AISI 316 con passacinghia.

| Cod. | A mm | C mm | UM | € |
|---------|------|------|----|---|
| 0211450 | 48 | 25 | PZ | |

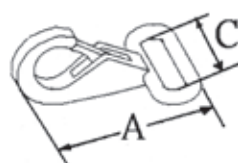
**Moschettone di Sicurezza Standard**

Moschettone di sicurezza con passa cima/cinghia per cinture di sicurezza e imbracature su barche a vela. Costruzione robustissima in Acciaio Inox AISI 316.

| Cod. | D mm | L mm | A mm | O mm | UM | € |
|---------|------|------|------|------|----|---|
| 0212580 | 8 | 80 | 14 | 16 | PZ | |
| 0212510 | 10 | 100 | 20 | 20 | PZ | |

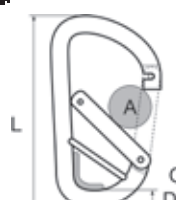
**Moschettone Assimetrico Wide Spring**

Moschettone in Acciaio Inox A4-AISI 316 tipo largo con ampia apertura e ritorno a molla.

| Cod. | D mm | L mm | A mm | UM | € |
|---------|------|------|------|----|---|
| 0211928 | 8 | 81 | 13 | PZ | |
| 0211930 | 10 | 102 | 15 | PZ | |
| 0211932 | 12 | 122 | 21 | PZ | |

MTM
QUALITY

Moschettone Standard

Moschettone Standard in Acciaio Inox AISI 316.

| Cod. | D mm | L mm | A mm | UM | € |
|---------|------|------|------|----|---|
| 0211150 | 5 | 50 | 8 | PZ | |
| 0211160 | 6 | 60 | 9 | PZ | |
| 0211170 | 7 | 70 | 9 | PZ | |
| 0211180 | 8 | 80 | 10 | PZ | |
| 0211110 | 10 | 100 | 12 | PZ | |
| 0211112 | 11 | 120 | 16 | PZ | |
| 0211114 | 12 | 140 | 20 | PZ | |
| 0211116 | 13 | 160 | 26 | PZ | |

**Moschettone Standard Eye**

Moschettone Standard in Acciaio Inox AISI 316 con occhio.

| Cod. | D mm | L mm | A mm | O mm | UM | € |
|---------|------|------|------|------|----|---|
| 0211350 | 5 | 50 | 8 | 7.5 | PZ | |
| 0211360 | 6 | 60 | 9 | 9 | PZ | |
| 0211370 | 7 | 70 | 9 | 10 | PZ | |
| 0211380 | 8 | 80 | 10 | 11.5 | PZ | |
| 0211310 | 10 | 100 | 12 | 14 | PZ | |
| 0211312 | 11 | 120 | 16 | 16.5 | PZ | |
| 0211314 | 12 | 140 | 20 | 18 | PZ | |
| 0211316 | 13 | 160 | 26 | 20 | PZ | |

**Moschettone Side**

Moschettone in Acciaio Inox AISI 316 con grande apertura laterale. Non impiglia cavi e cime.

| Cod. | D mm | L mm | A mm | UM | € |
|---------|------|------|------|----|---|
| 0211791 | 8 | 80 | 22 | PZ | |
| 0211792 | 10 | 100 | 24 | PZ | |
| 0211793 | 11 | 120 | 26 | PZ | |

**Moschettone Wide**

Moschettone in Acciaio Inox AISI 316 tipo largo con grande apertura.

| Cod. | D mm | L mm | A mm | UM | € |
|---------|------|------|------|----|---|
| 0211890 | 6 | 60 | 10 | PZ | |
| 0211891 | 8 | 80 | 13 | PZ | |
| 0211892 | 10 | 100 | 17 | PZ | |
| 0211893 | 11 | 120 | 22 | PZ | |

**Moschettone Wide Lock**

Moschettone in Acciaio Inox AISI 316 con grande apertura e ghiera di sicurezza.

| Cod. | D mm | L mm | A mm | UM | € |
|---------|------|------|------|----|---|
| 0211860 | 6 | 60 | 10 | PZ | |
| 0211880 | 8 | 80 | 14 | PZ | |
| 0211810 | 10 | 100 | 20 | PZ | |
| 0211812 | 11 | 120 | 24 | PZ | |

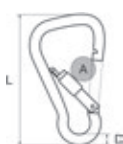
**Moschettone Wide Lock Eye**

Moschettone in Acciaio Inox AISI 316 con grande apertura, ghiera di sicurezza e occhio.

| Cod. | D mm | L mm | A mm | O mm | UM | € |
|---------|------|------|------|------|----|---|
| 0212060 | 6 | 60 | 10 | 9 | PZ | |
| 0212080 | 8 | 80 | 14 | 11 | PZ | |
| 0212010 | 10 | 100 | 20 | 14 | PZ | |
| 0212012 | 11 | 120 | 24 | 18 | PZ | |

**Moschettone Standard MTM**

Moschettone Standard in in Acciaio Inox 316 di qualità superiore fornito su Card da esposizione. Carico di lavoro (WL) testato e garantito. Il carico di rottura (BL) è 4 volte il carico di lavoro.

| Cod. | D mm | L mm | A mm | WL Kg | BL Kg | UM | € |
|----------|------|------|------|-------|-------|----|---|
| 0211150C | 5 | 50 | 8 | 90 | 360 | PZ | |
| 0211160C | 6 | 60 | 9 | 130 | 520 | PZ | |
| 0211180C | 8 | 80 | 10 | 180 | 720 | PZ | |
| 0211110C | 10 | 100 | 12 | 280 | 1120 | PZ | |

**Moschettone Standard Eye MTM**

Moschettone Standard in in Acciaio Inox 316 di qualità superiore con occhio fornito su Card da esposizione. Carico di lavoro (WL) testato e garantito. Il carico di rottura (BL) è 4 volte il carico di lavoro.

| Cod. | D mm | L mm | A mm | O mm | WL Kg | BL Kg | UM | € |
|----------|------|------|------|------|-------|-------|----|---|
| 0211350C | 5 | 50 | 8 | 7,5 | 90 | 360 | PZ | |
| 0211360C | 6 | 60 | 9 | 9 | 130 | 520 | PZ | |
| 0211380C | 8 | 80 | 10 | 11,5 | 180 | 720 | PZ | |
| 0211310C | 10 | 100 | 12 | 14 | 280 | 1120 | PZ | |



Moschettone Kong Standard

Moschettone in Acciaio Inox AISI 316 con sistema di aggancio antigrip. Non impiglia le cime.

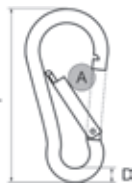

| Cod. | D mm | L mm | A mm | UM | € |
|---------|------|------|------|----|---|
| 0211605 | 5 | 50 | 7 | PZ | |
| 0211606 | 6 | 60 | 8 | PZ | |
| 0211607 | 7 | 72 | 10 | PZ | |
| 0211608 | 8 | 80 | 10 | PZ | |
| 0211610 | 10 | 103 | 15,5 | PZ | |
| 0211612 | 10,5 | 121 | 17 | PZ | |
| 0211613 | 13 | 160 | 30 | PZ | |

**Moschettone Kong Standard Eye**

Moschettone in Acciaio Inox AISI 316 con occhio sistema di aggancio antigrip. Non impiglia le cime.

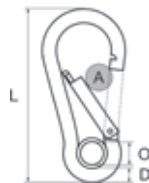

| Cod. | D mm | L mm | A mm | O mm | UM | € |
|---------|------|------|------|------|----|---|
| 0211615 | 5 | 50 | 7 | 6 | PZ | |
| 0211616 | 6 | 60 | 8 | 7 | PZ | |
| 0211617 | 7 | 72 | 10 | 9 | PZ | |
| 0211618 | 8 | 80 | 10 | 10 | PZ | |
| 0211620 | 10 | 103 | 15,5 | 12 | PZ | |
| 0211622 | 10,5 | 121 | 17 | 15 | PZ | |
| 0211623 | 13 | 160 | 30 | 22 | PZ | |

**Moschettone Kong Side**

Moschettone in Acciaio Inox AISI 316 con grande apertura laterale. Sistema di aggancio antigrip. Non impiglia le cime.

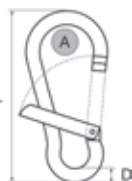

| Cod. | D mm | L mm | A mm | UM | € |
|---------|------|------|------|----|---|
| 0211781 | 8 | 80 | 22 | PZ | |
| 0211711 | 10 | 100 | 24 | PZ | |
| 0211712 | 11 | 120 | 26 | PZ | |

**Moschettone Kong Side Eye**

Moschettone in Acciaio Inox AISI 316 con grande apertura laterale e occhio. Sistema di aggancio antigrip. Non impiglia le cime.

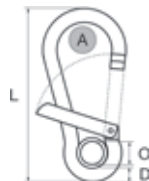

| Cod. | D mm | L mm | A mm | O mm | UM | € |
|---------|------|------|------|------|----|---|
| 0211981 | 8 | 80 | 24 | 11 | PZ | |
| 0211911 | 10 | 100 | 24 | 14 | PZ | |
| 0211912 | 11 | 120 | 26 | 18 | PZ | |

**Moschettone Kong Wide**

Moschettone in Acciaio Inox AISI 316 con grande apertura. Sistema di aggancio antigrip. Non impiglia le cime.

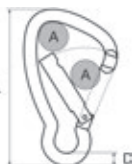

| Cod. | D mm | L mm | A mm | UM | € |
|---------|------|------|------|----|---|
| 0212150 | 5 | 52 | 9 | PZ | |
| 0212160 | 6 | 65 | 12 | PZ | |
| 0212180 | 8 | 85 | 18 | PZ | |
| 0212110 | 10 | 100 | 19 | PZ | |
| 0212112 | 11 | 125 | 26 | PZ | |

**Moschettone Kong Wide Eye**

Moschettone in Acciaio Inox AISI 316 con grande apertura e occhio. Sistema di aggancio antigrip. Non impiglia le cime.

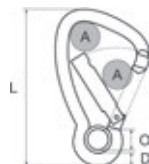

| Cod. | D mm | L mm | A mm | O mm | UM | € |
|---------|------|------|------|------|----|---|
| 0212350 | 5 | 52 | 9 | 8 | PZ | |
| 0212360 | 6 | 65 | 12 | 9 | PZ | |
| 0212380 | 8 | 85 | 18 | 11 | PZ | |
| 0212310 | 10 | 100 | 19 | 14 | PZ | |
| 0212312 | 11 | 125 | 26 | 18 | PZ | |

**Moschettone Kong Out Lock**

Moschettone in Acciaio Inox AISI 316 con apertura in fuori e ghiera di sicurezza. Sistema di aggancio antigrip. Non impiglia le cime.



| Cod. | D mm | L mm | A mm | UM | € |
|---------|------|------|------|----|---|
| 0211780 | 8 | 80 | 20 | PZ | |
| 0211710 | 10 | 100 | 24 | PZ | |

**Moschettone Kong Out Lock Eye**

Moschettone in Acciaio Inox AISI 316 con apertura in fuori, ghiera di sicurezza e occhio. Sistema di aggancio antigrip. Non impiglia le cime.



| Cod. | D mm | L mm | A mm | O mm | UM | € |
|---------|------|------|------|------|----|---|
| 0211980 | 8 | 80 | 20 | 11,5 | PZ | |
| 0211910 | 10 | 100 | 24 | 14 | PZ | |



Moschettone da Fiocco Aperto

Moschettone da fiocco aperto in Acciaio Inox AISI 316, utilizzato per l'attacco del fiocco su golfare di prua. Viene cucito su cinghia oppure piombato su cima, poi ribattuto.

| Cod. | L mm | O mm | UM | € |
|---------|------|------|----|---|
| 0222252 | 52 | 8 | PZ | |
| 0222265 | 65 | 10 | PZ | |

**Moschettone da Fiocco Chiuso**

Moschettone da fiocco chiuso in Acciaio Inox AISI 316, utilizzato per l'attacco del fiocco su golfare di prua. Viene cucito su cinghia oppure piombato su cima.

| Cod. | L mm | O mm | UM | € |
|---------|------|------|----|---|
| 0222350 | 50 | 7 | PZ | |
| 0222370 | 70 | 9 | PZ | |
| 0222310 | 100 | 14 | PZ | |

**Moschettone Spi Occhio Fisso**

Moschettone da spi fisso in Acciaio Inox AISI 316, utilizzato per le scotte e le drizze dello spinnaker o del fiocco. La scotta/drizza può essere piombata o annodata.

| Cod. | L mm | O mm | UM | € |
|---------|------|------|----|---|
| 0222550 | 55 | 9 | PZ | |
| 0222560 | 75 | 12 | PZ | |
| 0222590 | 99 | 15 | PZ | |

**Moschettone Spi Occhio Girevole**

Moschettone da spi girevole in Acciaio Inox AISI 316, utilizzato per le scotte e le drizze dello spinnaker o del fiocco. La scotta/drizza può essere piombata o annodata.

| Cod. | L mm | O mm | UM | € |
|---------|------|------|----|---|
| 0222670 | 70 | 12 | PZ | |
| 0222690 | 90 | 16 | PZ | |
| 0222613 | 127 | 22 | PZ | |

**Moschettone Spi con Grillo Girevole**

Moschettone da spi in Acciaio Inox AISI 316 con grillo girevole, utilizzato per le drizze dello spinnaker o del fiocco. Nel caso di drizze piombate, l'asse del grillo può essere facilmente sostituito se usurato.

| Cod. | L mm | O mm | UM | € |
|---------|------|------|----|---|
| 0222770 | 74 | 12 | PZ | |
| 0222790 | 94 | 14 | PZ | |
| 0222713 | 138 | 22 | PZ | |

**Moschettone da Fiocco Aperto MTM**

Moschettone da fiocco aperto in Acciaio Inox 316 di grado superiore. Controllo e finitura per il duro uso in mare. Fornito su elegante Card da esposizione. Testato e garantito nel carico di lavoro (WL). Il carico di rottura (BL) è 4 volte il carico di lavoro.

| Cod. | L mm | O mm | WL Kg | BL Kg | UM | € |
|---------|------|------|-------|-------|----|---|
| 022252C | 50 | 9 | 90 | 360 | PZ | |
| 022265C | 65 | 9 | 120 | 480 | PZ | |

**Moschettone da Fiocco Chiuso MTM**

Moschettone da fiocco chiuso in Acciaio Inox 316 di grado superiore. Controllo e finitura per il duro uso in mare. Fornito su elegante Card da esposizione. Testato e garantito nel carico di lavoro (WL). Il carico di rottura (BL) è 4 volte il carico di lavoro.

| Cod. | L mm | O mm | WL Kg | BL Kg | UM | € |
|----------|------|------|-------|-------|----|---|
| 0222350C | 50 | 7 | 65 | 260 | PZ | |
| 0222370C | 70 | 9 | 125 | 500 | PZ | |
| 0222310C | 100 | 14 | 225 | 900 | PZ | |

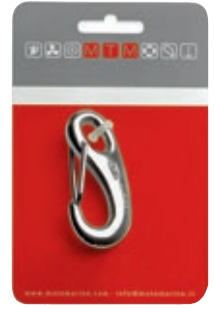
**Moschettone Spi Occhio Fisso MTM**

Moschettone da spi in Acciaio Inox 316 di grado superiore. Controllo e finitura per il duro uso in mare. Fornito su elegante Card da esposizione. Testato e garantito nel carico di lavoro (WL). Il carico di rottura (BL) è 4 volte il carico di lavoro.

| Cod. | L mm | O mm | WL Kg | BL Kg | UM | € |
|----------|------|------|-------|-------|----|---|
| 0222560C | 70 | 20 | 450 | 1800 | PZ | |
| 0222590C | 100 | 20 | 830 | 3320 | PZ | |

**Moschettone Spi Occhio Girevole MTM**

Moschettone girevole da spi in Acciaio Inox 316 di grado superiore. Controllo e finitura per il duro uso in mare. Fornito su elegante Card da esposizione. Testato e garantito nel carico di lavoro (WL). Il carico di rottura (BL) è 4 volte il carico di lavoro.

| Cod. | L mm | O mm | WL Kg | BL Kg | UM | € |
|----------|------|------|-------|-------|----|---|
| 0222670C | 70 | 12 | 160 | 640 | PZ | |
| 0222690C | 90 | 16 | 220 | 880 | PZ | |
| 0222613C | 127 | 22 | 400 | 1600 | PZ | |

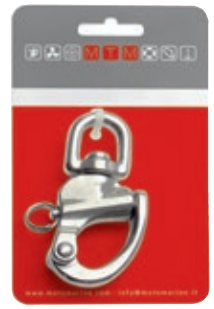
**Moschettone Spi con Grillo Girevole MTM**

Moschettone da spi in Acciaio Inox 316 di grado superiore con grillo girevole. Controllo e finitura per il duro uso in mare. Fornito su elegante Card da esposizione. Testato e garantito nel carico di lavoro (WL). Il carico di rottura (BL) è 4 volte il carico di lavoro.

| Cod. | L mm | O mm | WL Kg | BL Kg | UM | € |
|----------|------|------|-------|-------|----|---|
| 0222770C | 74 | 12 | 160 | 640 | PZ | |
| 0222790C | 94 | 12 | 220 | 880 | PZ | |
| 0222713C | 138 | 22 | 400 | 1600 | PZ | |



Ponticelli in Tondino

Ponticello lavorato in tondino di Acciaio Inox lucidato in confezioni da 10 pz.

| Cod. | D mm | W mm | W1 mm | UM | € |
|---------|------|------|-------|----|---|
| 0333340 | 4 | 40 | 10 | PZ | |
| 0333350 | 5 | 51 | 12 | PZ | |
| 0333360 | 6 | 60 | 14 | PZ | |
| 0333363 | 8 | 63 | 15 | PZ | |

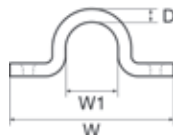
**Ponticelli Stampati S**

Ponticelli stampati in Acciaio Inox a base stretta in confezioni da 10 pz.

| Cod. | W mm | W1 mm | UM | € |
|---------|------|-------|----|---|
| 0333022 | 38 | 10 | PZ | |
| 0333024 | 47 | 14 | PZ | |
| 0333026 | 55 | 20 | PZ | |

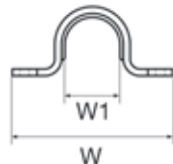
**Ponticelli Stampati L**

Ponticelli stampati in Acciaio Inox a base larga in confezioni da 10 pz.

| Cod. | W mm | W1 mm | UM | € |
|---------|------|-------|----|---|
| 0333213 | 45 | 13 | PZ | |
| 0333216 | 48 | 16 | PZ | |

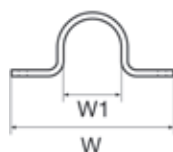
**Ponte Passacinghia**

Ponte passacinghia lavorato in tondino di Acciaio Inox lucidato in confezioni da 10 pz.

| Cod. | D mm | W mm | W1 mm | UM | € |
|---------|------|------|-------|----|---|
| 0333355 | 5 | 78 | 40 | PZ | |
| 0333362 | 6 | 92 | 50 | PZ | |

**Anello su Piastra 4 Fori**

Piastra a 4 fori con anello tondo in Acciaio Inox.

| Cod. | W mm | L mm | O mm | D mm | H mm | UM | € |
|---------|------|------|------|------|------|----|---|
| 0234430 | 30 | 35 | 30 | 5 | 20 | PZ | |
| 0234435 | 35 | 40 | 40 | 6 | 26 | PZ | |
| 0234440 | 40 | 50 | 40 | 8 | 32 | PZ | |

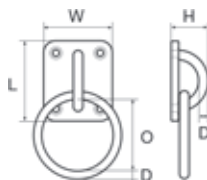
**Anello su Piastra 3 Fori HD**

Piastra a 3 fori con anello in Acciaio Inox da fusione. Finitura e qualità eccezionali.

| Cod. | L mm | W mm | D mm | UM | € |
|---------|------|------|------|----|---|
| 0234346 | 44 | 44 | 6 | PZ | |
| 0234348 | 57 | 60 | 8 | PZ | |
| 0234350 | 76 | 75 | 10 | PZ | |

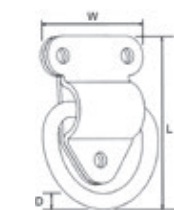
**Anello Doppio su Piastra 4 Fori HD**

Piastra a 4 fori con doppio anello in Acciaio Inox da fusione. Finitura e qualità eccezionali.

| Cod. | L mm | W mm | D mm | UM | € |
|---------|------|------|------|----|---|
| 0234360 | 79 | 45 | 10 | PZ | |



Ponticello su Piastra Pad Eye 2

Ponticello su piastra in Acciaio Inox con 2 fori.

| Cod. | D mm | L mm | W mm | UM | € |
|---------|------|------|------|----|---|
| 0235045 | 5 | 45 | 15 | PZ | |
| 0235060 | 6 | 60 | 20 | PZ | |
| 0235080 | 8 | 80 | 26 | PZ | |

**Ponticello su Piastra Pad Eye 4**

Ponticello su piastra in Acciaio Inox con 4 fori.

| Cod. | D mm | L mm | W mm | UM | € |
|---------|------|------|------|----|---|
| 0234035 | 5 | 35 | 30 | PZ | |
| 0234040 | 6 | 40 | 35 | PZ | |
| 0234050 | 8 | 50 | 40 | PZ | |

**- GOLFARI E ANELLI IN ACCIAIO INOX -****Golfare-Cavallotto U-Bolt P**

Golfare-Cavallotto in Acciaio Inox AISI316 con rondino pizzicato.

| Cod. | D mm | M mm | L mm | W mm | H mm | UM | € |
|---------|------|------|------|------|------|----|---|
| 0230004 | 4 | 4 | 64 | 30 | 30 | PZ | |
| 0230005 | 5 | 5 | 80 | 35 | 40 | PZ | |
| 0230006 | 6 | 6 | 90 | 35 | 40 | PZ | |
| 0230008 | 8 | 8 | 100 | 35 | 50 | PZ | |
| 0230010 | 10 | 10 | 130 | 50 | 55 | PZ | |
| 0230012 | 12 | 12 | 150 | 60 | 65 | PZ | |

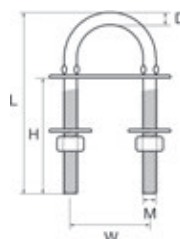
**Golfare-Cavallotto U-Bolt S**

Golfare-Cavallotto in Acciaio Inox con rondino ingrossato.

| Cod. | D mm | M mm | L mm | W mm | H mm | UM | € |
|---------|------|------|------|------|------|----|---|
| 0230105 | 6 | 5 | 78 | 36 | 48 | PZ | |
| 0230106 | 8 | 6 | 90 | 36 | 42 | PZ | |
| 0230108 | 10 | 8 | 100 | 45 | 52 | PZ | |
| 0230110 | 12 | 10 | 135 | 50 | 80 | PZ | |
| 0230112 | 14 | 12 | 150 | 60 | 85 | PZ | |

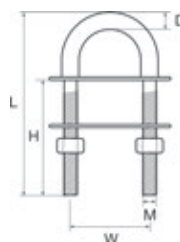
**Golfare-Cavallotto U-Bolt Roca**

Golfare-Cavallotto Roca in Acciaio Inox svedese di resistenza superiore con rondino pizzicato, due piastrelle e dadi autobloccanti. Finitura perfetta lucidata a specchio.

| Cod. | D mm | M mm | L mm | W mm | H mm | UM | € |
|---------|------|------|------|------|------|----|---|
| 0230320 | 8 | 8 | 60 | 32 | 30 | PZ | |
| 0230321 | 8 | 8 | 70 | 32 | 35 | PZ | |
| 0230322 | 8 | 8 | 80 | 32 | 45 | PZ | |
| 0230323 | 8 | 8 | 90 | 32 | 55 | PZ | |
| 0230324 | 10 | 10 | 105 | 40 | 65 | PZ | |

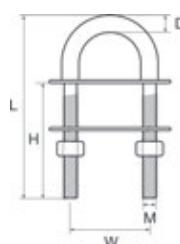
**Golfare-Cavallotto U-Bolt G**

Golfare-Cavallotto in Acciaio Inox con rondino ingrossato e dadi autogrippanti con serraggio facilitato.

| Cod. | D mm | M mm | L mm | W mm | H mm | UM | € |
|---------|------|------|------|------|------|----|---|
| 0230118 | 10 | 8 | 100 | 40 | 60 | PZ | |
| 0230120 | 12 | 10 | 100 | 40 | 48 | PZ | |
| 0230122 | 14 | 12 | 120 | 50 | 58 | PZ | |

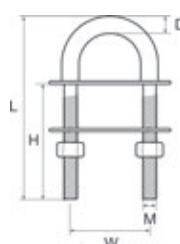

Golfare con Occhio Saldato

Golfare Inox con perno e occhio saldato.

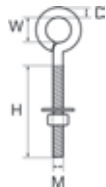

| Cod. | M mm | H mm | W mm | D mm | UM | € |
|---------|------|------|------|------|----|---|
| 0231040 | 6 | 40 | 13 | 6 | PZ | |
| 0231060 | 6 | 60 | 13 | 6 | PZ | |
| 0231180 | 8 | 70 | 17 | 8 | PZ | |
| 0231110 | 10 | 90 | 21 | 10 | PZ | |
| 0231112 | 12 | 105 | 25 | 12 | PZ | |

Golfare con Occhio Tornito

Golfare Inox con perno e occhio tornito.

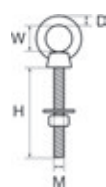

| Cod. | M mm | H mm | W mm | D mm | UM | € |
|---------|------|------|------|------|----|---|
| 0231240 | 6 | 40 | 12 | 5 | PZ | |
| 0231260 | 6 | 60 | 12 | 5 | PZ | |
| 0231280 | 8 | 80 | 14 | 6 | PZ | |
| 0231210 | 10 | 100 | 16 | 8 | PZ | |
| 0231212 | 12 | 140 | 18 | 10 | PZ | |

Anello su Perno Ring Bolt

Anello su perno filettato in Acciaio Inox.



| Cod. | M mm | H mm | W mm | D mm | UM | € |
|---------|------|------|------|------|----|---|
| 0232008 | 8 | 75 | 45 | 8 | PZ | |
| 0232010 | 10 | 65 | 50 | 9 | PZ | |
| 0232012 | 12 | 80 | 60 | 12 | PZ | |

Testa Golfare M

Testa golfare maschio in Acciaio Inox.



| Cod. | M mm | W mm | D mm | UM | € |
|---------|------|------|------|----|---|
| 0231606 | 6 | 15 | 6 | PZ | |
| 0231608 | 8 | 20 | 8 | PZ | |
| 0231610 | 10 | 25 | 10 | PZ | |
| 0231612 | 12 | 30 | 10 | PZ | |
| 0231616 | 16 | 35 | 14 | PZ | |

Testa Golfare F

Testa golfare femmina in Acciaio Inox.

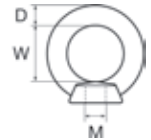

| Cod. | M mm | W mm | D mm | UM | € |
|---------|------|------|------|----|---|
| 0231506 | 6 | 19 | 8 | PZ | |
| 0231508 | 8 | 19 | 8 | PZ | |
| 0231510 | 10 | 24 | 10 | PZ | |
| 0231512 | 12 | 28 | 12 | PZ | |
| 0231516 | 16 | 35 | 14 | PZ | |

Anello Tondo

Anello tondo in Acciaio Inox.



| Cod. | D mm | W mm | UM | € |
|---------|------|------|----|---|
| 0236020 | 3 | 20 | PZ | |
| 0236025 | 3 | 25 | PZ | |
| 0236028 | 4 | 25 | PZ | |
| 0236030 | 4 | 30 | PZ | |
| 0236040 | 5 | 40 | PZ | |
| 0236050 | 5 | 50 | PZ | |
| 0236055 | 6 | 50 | PZ | |
| 0236060 | 6 | 60 | PZ | |
| 0236065 | 8 | 60 | PZ | |
| 0236070 | 8 | 70 | PZ | |

Anello a D

Anello a D in Acciaio Inox.

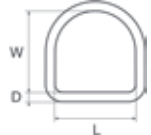

| Cod. | D mm | W mm | L mm | UM | € |
|---------|------|------|------|----|---|
| 0236332 | 3 | 17 | 20 | PZ | |
| 0236333 | 3 | 22 | 26 | PZ | |
| 0236342 | 4 | 22 | 27 | PZ | |
| 0236343 | 4 | 25 | 30 | PZ | |
| 0236353 | 5 | 25 | 30 | PZ | |
| 0236354 | 5 | 34 | 40 | PZ | |
| 0236364 | 6 | 35 | 40 | PZ | |
| 0236365 | 6 | 50 | 47 | PZ | |

Anello Triangolo

Anello triangolare in Acciaio Inox.



| Cod. | D mm | L mm | UM | € |
|---------|------|------|----|---|
| 0236384 | 5 | 30 | PZ | |
| 0236385 | 6 | 40 | PZ | |
| 0236386 | 6 | 50 | PZ | |
| 0236388 | 8 | 50 | PZ | |

Anello a D con Barra

Anello a D con barra in Acciaio Inox.



| Cod. | D mm | L mm | H mm | UM | € |
|---------|------|------|------|----|---|
| 0236390 | 5 | 45 | 5,5 | PZ | |
| 0236391 | 6 | 50 | 7 | PZ | |
| 0236392 | 8 | 50 | 8 | PZ | |

Gancetto Stampato Inox

Gancetto stampato in Acciaio Inox.

| Cod. | L mm | W mm | H mm | UM | € |
|----------------|------|------|------|----|---|
| 0332500 | 19 | 33 | 12 | PZ | |



Gancetto Stampato Cromato

Gancetto stampato in Ottone Cromato.

| Cod. | L mm | W mm | H mm | UM | € |
|----------------|------|------|------|----|---|
| 0332501 | 19 | 33 | 12 | PZ | |



Gancetto Inox

Gancetto classico in Acciaio Inox.

| Cod. | L mm | W mm | H mm | UM | € |
|----------------|------|------|------|----|---|
| 0331010 | 27 | 27 | 19 | PZ | |

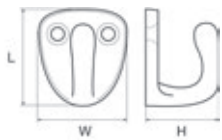

Gancetto Cromato

Gancetto classico in Ottone Cromato.

| Cod. | L mm | W mm | H mm | UM | € |
|----------------|------|------|------|----|---|
| 0331000 | 27 | 27 | 19 | PZ | |

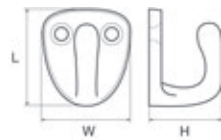

Gancetto Stretto Inox

Gancetto stretto in Acciaio Inox.

| Cod. | L mm | W mm | H mm | UM | € |
|----------------|------|------|------|----|---|
| 0331009 | 39 | 17 | 31 | PZ | |

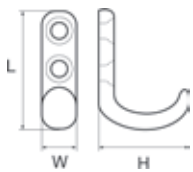

Gancetto Stretto HQ Inox

Gancetto stretto in Acciaio Inox A4-AISI 316.

| Cod. | L mm | W mm | H mm | UM | € |
|----------------|------|------|------|----|---|
| 0331008 | 40 | 13 | 27 | PZ | |

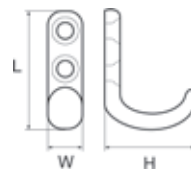

Gancetto Chiuso Inox

Gancetto chiuso in Acciaio Inox.

| Cod. | L mm | W mm | H mm | O mm | UM | € |
|----------------|------|------|------|------|----|---|
| 0331300 | 35 | 30 | 21 | 10 | PZ | |



Gancetto Chiuso Cromato

Gancetto chiuso in Ottone Cromato.

| Cod. | L mm | W mm | H mm | O mm | UM | € |
|----------------|------|------|------|------|----|---|
| 0331301 | 30 | 30 | 19 | 9 | PZ | |



Gancetto Spring Inox

Gancetto a scatto in Acciaio Inox per parabordi e cime.

| Cod. | L mm | W mm | H mm | A mm | UM | € |
|----------------|------|------|------|------|----|---|
| 0331614 | 38 | 34 | 24 | 6 | PZ | |
| 0331617 | 42 | 32 | 32 | 10 | PZ | |

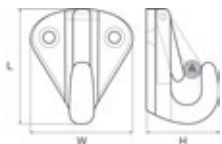

Gancetto Spring Cromato

Gancetto a scatto in Ottone Cromato per parabordi e cime.

| Cod. | L mm | W mm | H mm | A mm | UM | € |
|----------------|------|------|------|------|----|---|
| 0331604 | 36 | 33 | 25 | 8 | PZ | |
| 0331607 | 43 | 33 | 33 | 10 | PZ | |

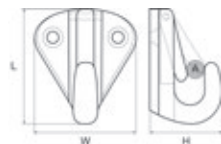

Gancetto Doppio

Gancetto a 2 punte in Acciaio Inox AISI 316-A4.

| Cod. | L mm | W mm | Interasse fori mm | UM | € |
|----------------|------|------|-------------------|----|---|
| 1113505 | 50 | 10 | 8,5 | PZ | |
| 1113508 | 80 | 10 | 16,8 | PZ | |



Bitta Light Weight

Bittina ferma-bandiera/ferma-teli in Acciaio Inox 316. Base con 2 fori di fissaggio.

| Cod. | L mm | Interasse fori mm | UM | € |
|----------------|------|-------------------|----|---|
| 1113506 | 67 | 10 | PZ | |
| 1113511 | 112 | 21 | PZ | |

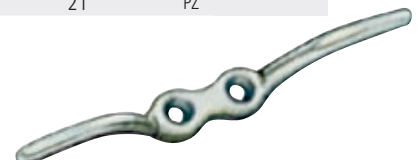

FERRAMENTA/CHIUSURE/VITERIA

2

Gancetto L a Vite

Gancetto L a vite in Acciaio Inox.

| Cod. | L mm | H mm | UM | € |
|----------------|------|------|----|---|
| 0333450 | 40 | 15 | PZ | |
| 0333460 | 45 | 20 | PZ | |
| 0333470 | 50 | 22 | PZ | |



Gancetto U a Vite

Gancetto U a vite in Acciaio Inox.

| Cod. | L mm | W mm | UM | € |
|----------------|------|------|----|---|
| 0333650 | 35 | 10 | PZ | |
| 0333660 | 41 | 12 | PZ | |
| 0333670 | 50 | 17 | PZ | |



Gancetto O a Vite

Gancetto O a vite in Acciaio Inox.

| Cod. | L mm | W mm | UM | € |
|----------------|------|------|----|---|
| 0333850 | 33 | 7 | PZ | |
| 0333860 | 36 | 8 | PZ | |
| 0333870 | 46 | 10 | PZ | |



Gancetto Porta Tazze

Gancetto porta tazze in Ottone Cromato completo con vite L40 mm e tassello M6.

| Cod. | L mm | W mm | UM | € |
|----------------|------|------|----|---|
| 0335500 | 27 | 10 | PZ | |
| 0335502 | 32 | 12 | PZ | |

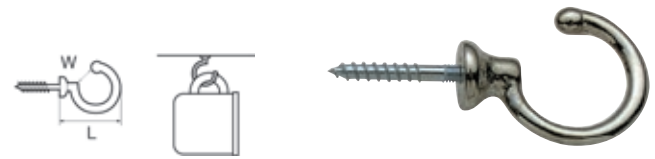

Gancio Appendiabiti Singolo

Gancio appendiabiti singolo in Ottone.

| Cod. | Base mm | Ottone | UM | € |
|----------------|---------|---------|----|---|
| 0335601 | 15 x 40 | Oro | PZ | |
| 0335501 | 15 x 40 | Cromato | PZ | |



Gancio Appendiabiti Doppio

Gancio appendiabiti doppio in Ottone.

| Cod. | mm | Ottone | UM | € |
|----------------|---------|---------|----|---|
| 0335302 | 40 x 55 | Oro | PZ | |
| 0335301 | 40 x 55 | Cromato | PZ | |

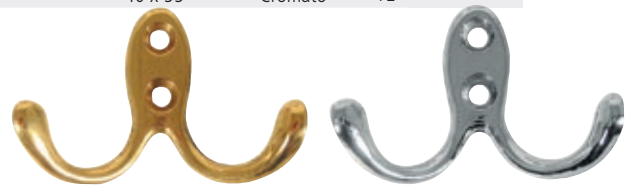

Appendiabiti a 3 Ganci Pieghevoli

Appendiabiti a 3 ganci pieghevoli in Ottone.

| Cod. | Base mm | Ottone | UM | € |
|----------------|---------|---------|----|---|
| 0335303 | 73 x 36 | Oro | PZ | |
| 0335305 | 73 x 36 | Cromato | PZ | |



Appendiabiti a 4 Ganci Pieghevoli

Appendiabiti a 4 ganci pieghevoli in Ottone.

| Cod. | Base mm | Ottone | UM | € |
|----------------|---------|---------|----|---|
| 0335304 | 73 x 36 | Oro | PZ | |
| 0335306 | 73 x 36 | Cromato | PZ | |



Gancio Appendiabiti Doppio Long

Gancio appendiabiti doppio in Ottone.

| Cod. | Base mm | Ottone | UM | € |
|----------------|---------|---------|----|---|
| 0335308 | 28 x 39 | Oro | PZ | |
| 0335309 | 28 x 39 | Cromato | PZ | |

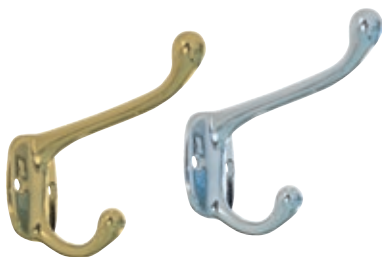

Gancio a Scomparsa

Gancio a scomparsa a scomparsa.

| Cod. | Base mm | Materiale | UM | € |
|----------------|---------|----------------|----|---|
| 0335605 | 80 x 25 | Acciaio Inox | PZ | |
| 0335606 | 75 x 25 | Ottone Cromato | PZ | |



Gancio a Scomparsa Inox Mini

Gancio a scomparsa a scomparsa in Acciaio Inox A4-AISI 316.

| Cod. | Base mm | UM | € |
|----------------|---------|----|---|
| 0335604 | 50 x 28 | PZ | |



Gancio Inox Hanger M

Gancio da lavoro in Acciaio Inox stampato.

| Cod. | L mm | UM | € |
|----------------|------|----|---|
| 0332921 | 98 | PZ | |



Gancio Inox Hanger L

Gancio in Acciaio Inox per salvagenti, cime, sagole e qualsiasi attrezzatura di bordo.

| Cod. | L mm | UM | € |
|----------------|------|----|---|
| 0332922 | 178 | PZ | |



Ganci Appendicime in Nylon

Ganci appendicime in Nylon.

| Cod. | L mm | W mm | H mm | UM | € |
|----------------|------|------|------|----|---|
| 0332912 | 80 | 57 | 50 | PZ | |
| 0332913 | 95 | 57 | 65 | PZ | |



Gancio Appendicime in Nylon con Morsetto

Gancio appendicime in Nylon con attacco a morsetto per tubi da 22<>25 mm.

| Cod. | UM | € |
|----------------|----|---|
| 0332915 | PZ | |



- GANCI E GANCETTI IN PLASTICA -

Gancetto Orizzontale in Nylon

Gancetto orizzontale in Nylon in confezione da 10 pezzi.

| Cod. | L mm | W mm | H mm | Colore | UM | € |
|----------------|------|------|------|--------|----|---|
| 0332200 | 29 | 30 | 16 | NERO | PZ | |
| 0332210 | 29 | 30 | 16 | BIANCO | PZ | |



Gancetto Verticale in Nylon

Gancetto verticale in Nylon in confezione da 10 pezzi.

| Cod. | L mm | W mm | H mm | Colore | UM | € |
|----------------|------|------|------|--------|----|---|
| 0331901 | 40 | 18 | 16 | NERO | PZ | |
| 0331902 | 40 | 18 | 16 | BIANCO | PZ | |

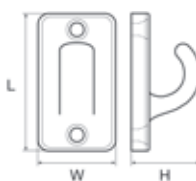

Gancetto Ovale in Nylon

Gancetto ovale in Nylon in confezione da 50 pezzi.

| Cod. | L mm | W mm | H mm | UM | € |
|----------------|------|------|------|----|---|
| 0331900 | 39 | 19 | 17 | PZ | |

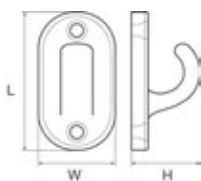

Gancetto Passante in Nylon

Gancetto passante in Nylon in confezione da 10 pezzi.

| Cod. | L mm | W mm | ø mm | Colore | UM | € |
|----------------|------|------|------|--------|----|---|
| 0332214 | 30 | 15 | 10 | NERO | PZ | |
| 0332215 | 30 | 15 | 10 | BIANCO | PZ | |

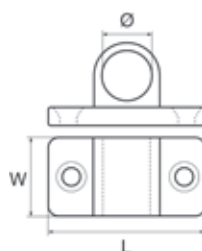

Gancetto Bianco per Elastici

Gancetto per elastici in Nylon Bianco.

| Cod. | Elastico ø mm | UM | € |
|---------|---------------|----|---|
| 0332804 | 4 | PZ | |
| 0332805 | 5* | PZ | |
| 0332806 | 6 | PZ | |
| 0332808 | 8 | PZ | |
| 0332810 | 10 | PZ | |

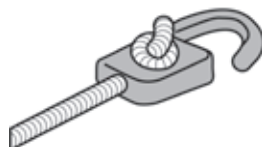
**Gancetto Nero per Elastici**

Gancetto per elastici in Nylon Nero.

| Cod. | Elastico ø mm | UM | € |
|---------|---------------|----|---|
| 0332704 | 4 | PZ | |
| 0332705 | 5* | PZ | |
| 0332706 | 6 | PZ | |
| 0332708 | 8 | PZ | |
| 0332710 | 10 | PZ | |

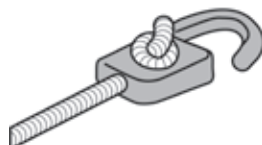
**Gancetto Flat per Elastici**

Gancetto in Nylon largo e piatto in confezioni da 10 pz per attacco sul bordo di gommoni.

| Cod. | Elastico ø mm | Colore | UM | € |
|---------|---------------|--------|----|---|
| 0332600 | 6/8 | NERO | PZ | |
| 0332610 | 6/8 | BIANCO | PZ | |
| 0332620 | 6/8 | GRIGIO | PZ | |

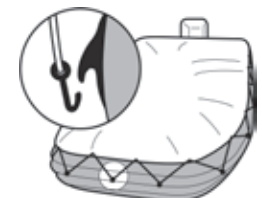
**Clip Autobloccante per Elastici**

Clip autobloccante in Nylon per elastici.

| Cod. | Elastico ø mm | Colore | UM | € |
|---------|---------------|--------|----|---|
| 0332835 | 5/6 | BLUE | PZ | |
| 0332836 | 5/6 | NERO | PZ | |

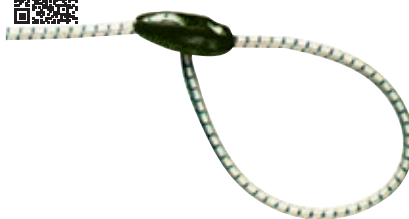
**Gancetto Autobloccante Bianco per Elastici**

Gancetto Autobloccante in Nylon Bianco per elastici.

| Cod. | Elastico ø mm | UM | € |
|---------|---------------|----|---|
| 0332843 | 5<>6 | PZ | |
| 0332844 | 8 | PZ | |

**Gancetto Autobloccante Nero per Elastici**

Gancetto Autobloccante in Nylon Nero per elastici.

| Cod. | Elastico ø mm | UM | € |
|---------|---------------|----|---|
| 0332840 | 5<>6 | PZ | |
| 0332842 | 8 | PZ | |

**Gancetto Inox per Elastici**

Gancetto in Acciaio Inox per elastici.

| Cod. | Elastico ø mm | UM | € |
|---------|---------------|----|---|
| 0332816 | 6 | PZ | |
| 0332818 | 8 | PZ | |
| 0332820 | 10 | PZ | |



Gancio Fermaporte Semplice Ottone Cromato

Gancio fermaporte in Ottone Cromato.

| Cod. | mm | UM | € |
|----------------|----|----|---|
| 0334708 | 80 | PZ | |

**Gancio Fermaporte Inox**

Gancio fermaporte in Acciaio Inox AISI 316.

| Cod. | mm | UM | € |
|----------------|----|----|---|
| 0334805 | 51 | PZ | |
| 0334807 | 76 | PZ | |

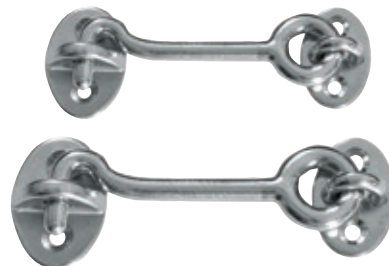
**Gancio Fermaporte Doppio Snodo Ottone Cromato**

Gancio fermaporte doppio snodo in Ottone Cromato.

| Cod. | mm | UM | € |
|----------------|-----|----|---|
| 0334806 | 60 | PZ | |
| 0334808 | 80 | PZ | |
| 0334810 | 100 | PZ | |

**Gancio Fermaporte Doppio Snodo Inox**

Gancio fermaporte doppio snodo in Acciaio Inox.

| Cod. | mm | UM | € |
|----------------|-----|----|---|
| 0334820 | 100 | PZ | |

**Chiusura a Tavella Semplice**

Chiusura a tavella in Ottone Cromato.

| Cod. | mm | UM | € |
|----------------|---------|----|---|
| 0335233 | 52 x 43 | PZ | |

**Catenaccio Smooth Ottone Cromato**

Catenaccio in Ottone Cromato con angoli smussati.

| Cod. | mm | UM | € |
|----------------|---------|----|---|
| 0342459 | 59 x 27 | PZ | |
| 0342490 | 90 x 30 | PZ | |

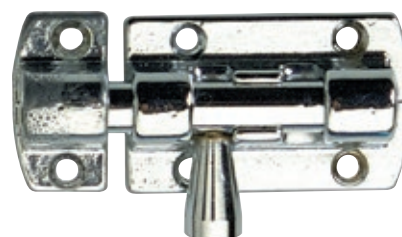

Catenaccio Standard Ottone Cromato

Catenaccio in Ottone Cromato.

| Cod. | mm | UM | € |
|---------|----------|----|---|
| 0342412 | 115 x 25 | PZ | |

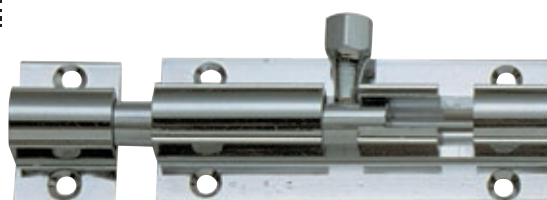
**Catenaccio Standard Inox**

Catenaccio a barra classico in Acciaio Inox 316.

| Cod. | mm | UM | € |
|---------|---------|----|---|
| 0342572 | 70 x 25 | PZ | |

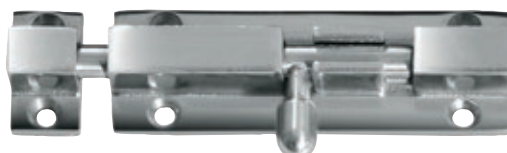
**Catenaccio Smooth Inox**

Catenaccio in Acciaio Inox con angoli smussati.

| Cod. | mm | UM | € |
|---------|----------|----|---|
| 0342580 | 75 x 30 | PZ | |
| 0342581 | 90 x 38 | PZ | |
| 0342582 | 115 x 38 | PZ | |

**Catenaccio Silenziato Smooth Handle Ottone Cromato**

Catenaccio in Ottone Cromato con maniglia antirumore rivestita in Nylon nero.

| Cod. | mm | UM | € |
|---------|---------|----|---|
| 0342491 | 85 x 30 | PZ | |

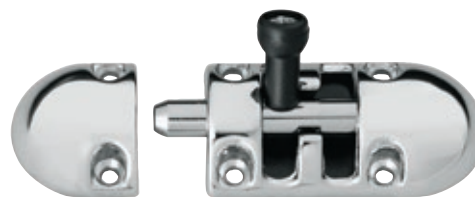
**Catenaccio a Molla Smooth Ottone Cromato**

Catenaccio in Ottone Cromato con meccanismo a molla. Corpo senza appigli con angoli smussati.

| Cod. | mm | UM | € |
|---------|----------------|----|---|
| 0342450 | 120 x 40 x H12 | PZ | |

**Catenaccio a Molla Tmarine Inox**

Catenaccio ad appoggio in Acciaio Inox 316 extralucido con meccanismo a molla.

| Cod. | A mm | B mm | C mm | D mm | Sconto | UM | € |
|---|------|------|------|------|-------------|----|---|
| 0342590 | 15 | 67 | 22 | 31 | da Appoggio | PZ | |
| 0342591  | 15 | 67 | 15 | 35 | a Incasso | PZ | |

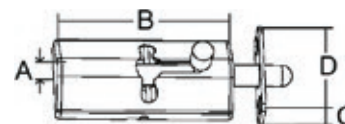
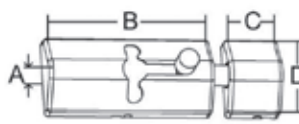
 Tmarine

Chiusura a Molla Locking Hasp

Chiusura a spinta in Acciaio Inox per gavoni. Pulsante a molla con anello e foro portaluchetto.

| Cod. | L mm | Piastra mm | UM | € |
|----------------|------|------------|----|---|
| 0342101 | 56 | 50 x 34 | PZ | |

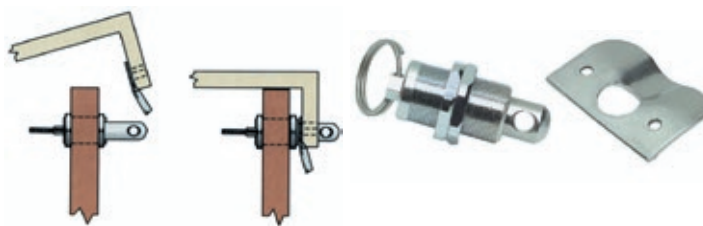
**Chiusura a Molla Pin Latch**

Chiusura in Acciaio Inox 316 con perno a molla per fissare, bloccare o chiudere gavoni e cassoni.

| Cod. | A mm | B mm | C mm | D max mm | UM | € |
|----------------|------|------|------|----------|----|---|
| 0342104 | 9,5 | 56,2 | 28 | 18,5 | PZ | |

**Arresto a Spinta Snap In**

Arresto a spinta in gomma e nylon per portelli, gavoni e cassoni con montaggio della base ad incasso (spessore paratia max 13 mm). L'attacco maschio può essere regolato in altezza grazie al distanziatore incluso (H11<>16 mm). Per un montaggio preciso si consiglia l'uso del punzone che quando inserito segna il punto di contatto esatto.

| Cod. | Base dim mm | Accessori | UM | € |
|--|-------------|-----------|----|---|
| 0342760 | ø 39 x H46 | | PZ | |
| 0342775  | | Punzone | PZ | |

**Arresto a Spinta Snap In Inox**

Arresto a spinta in gomma e nylon con cornice in Acciaio Inox AISI316 per portelli, gavoni e cassoni con montaggio della base ad incasso. L'attacco maschio può essere regolato in altezza grazie al distanziatore incluso (H11<>16 mm). Per un montaggio preciso si consiglia l'uso del punzone che quando inserito segna il punto di contatto esatto.

| Cod. | Base dim mm | Accessori | UM | € |
|----------------|-------------|-----------|----|---|
| 0342770 | ø 28 x H26 | | PZ | |
| 0342775 | | Punzone | PZ | |

**Arresto a Spinta Snap Top**

Arresto a spinta in gomma e nylon per portelli, gavoni e cassoni con montaggio della base sulla superficie. L'attacco maschio può essere regolato in altezza grazie al distanziatore incluso (H11<>16 mm). Per un montaggio preciso si consiglia l'uso del punzone che quando inserito segna il punto di contatto esatto.

| Cod. | Base dim mm | Accessori | UM | € |
|--|-------------|-----------|----|---|
| 0342750 | ø 21 x H20 | | PZ | |
| 0342775  | | Punzone | PZ | |

**Arresto a Spinta Snap Side**

Arresto a spinta in Nylon e Gomma per portelli, gavoni e cassoni. Montaggio dell'attacco maschio su supporto in Acciaio Inox che può essere fissato a paratia all'altezza desiderata. Fissaggio base a superficie.

| Cod. | Base dim mm | Supporto inox dim mm | UM | € |
|----------------|-------------|----------------------|----|---|
| 0342752 | ø 21 x H20 | 32 x 16 x P22 | PZ | |



Chiusura a Molla Tmarine a Incasso

Chiusura a incasso in Acciaio Inox AISI316 per portelli e paglioli. Con meccanismo a molla che può essere aperto dall'esterno e dall'interno.



| Cod. | Dim mm | UM | € |
|---------|---------|----|---|
| 0342584 | 56 x 91 | PZ | |

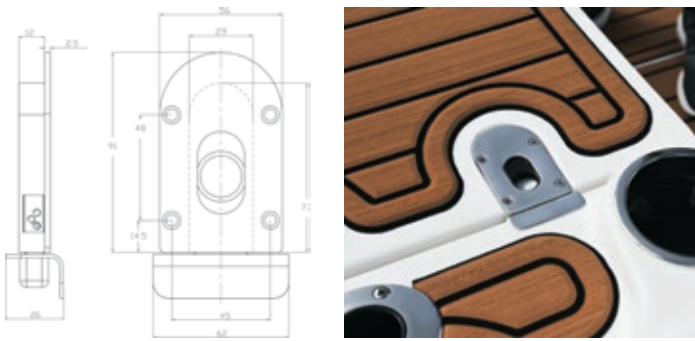

Tmarine Tamarini

Sgancio a Strappo Sundecker

Southco Sundecker è una chiusura con sgancio a strappo per chiudere ed aprire a distanza portelli, gavoni e cassoni (basta tirare la cinghietta). Installazione facile e veloce in più versi e posizioni. Lunghezza cinghia 1 metro.



| Cod. | Dim mm | L cinghia | Verso | UM | € |
|---------|----------|-----------|-------|----|---|
| 0342730 | 53 x 115 | 1 m | North | PZ | |
| 0342731 | 53 x 115 | 1 m | South | PZ | |

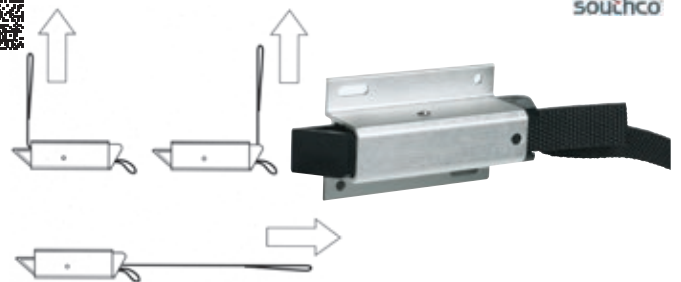

southco

Chiusura a Spinta Parrot

Chiusura a scomparsa parziale o totale Southco Parrot. Piastrina fonoassorbente per eliminare rumori alla chiusura. Riscontro regolabile per risolvere problemi di allineamento. Corpo in Plastica rinforzata.



| Cod. | Dim mm | UM | € |
|---------|---------|----|---|
| 0342715 | 70 x 50 | PZ | |



southco

Chiusura a Dente in Ottone

Chiusura a dente in Ottone per portelli e antine. Si usa con maniglie passanti o praticando un semplice foro nel portello.

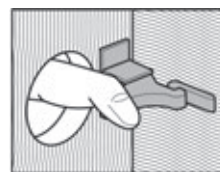

| Cod. | UM | € |
|---------|----|---|
| 0335015 | PZ | |

**Arresto a Spinta Ottone Cromato**

Arresto a spinta in Ottone Cromato per porte e portelli.



| Cod. | Dim mm | UM | € |
|---------|---------|----|---|
| 0342802 | 60 x 12 | PZ | |

**Arresto a Spinta Inox**

Arresto a spinta in Acciaio Inox per porte e portelli.



| Cod. | Dim mm | UM | € |
|---------|---------|----|---|
| 0342805 | 29 x 26 | PZ | |
| 0342806 | 40 x 32 | PZ | |

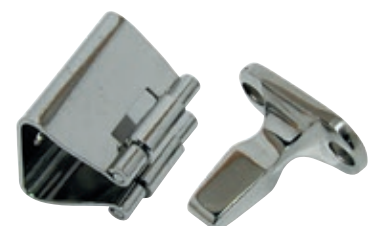

Arresto a Spinta Mini

Arresto a spinta per cassetti e antine. Base e attacco in Plastica.

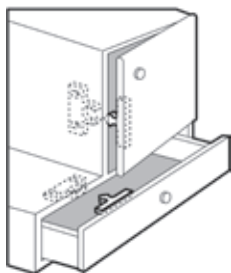

| Cod. | Dim mm | UM | € |
|---------|--------|----|---|
| 0342700 | 30 x 7 | PZ | |

**Arresto a Spinta Grab**

Arresto a spinta in plastica rinforzata per porte e portelli.

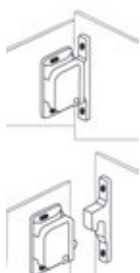

| Cod. | Dim base mm | Dim gancio mm | UM | € |
|---------|---------------|---------------|----|---|
| 0342703 | 48 x 28 x H14 | 73 x 11 | PZ | |

**Arresto a Spinta PL**

Arresto a spinta in Plastica per porte e portelli completo di viteria. Meccanismo di incastro morbido a molla.

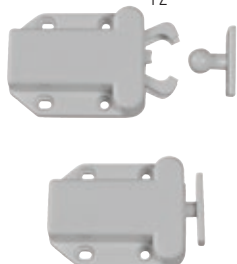
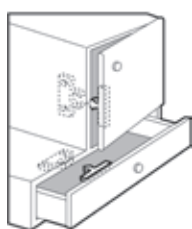

| Cod. | Dim mm | UM | € |
|---------|---------------|----|---|
| 0342707 | 43 x 55 x H17 | PZ | |

**Arresto a Spinta YD**

Arresto a spinta per cassetti e antine. Base e attacco in lega Zamac con finitura Ottone oppure Cromato. Venduti in coppia.

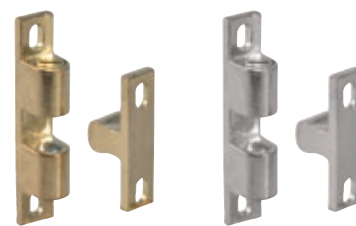
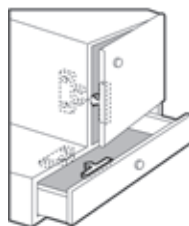

| Cod. | Finitura | Dim base mm | Dim attacco mm | UM | € |
|---------|----------|-------------|----------------|----|---|
| 0342801 | Ottone | 49 x 9 | 32 x 9 | CP | |
| 0342803 | Cromato | 49 x 9 | 32 x 9 | CP | |

**Arresto a Spinta Grabber**

Arresto a spinta Southco Grabber in plastica rinforzata per cassetti e porte.



| Cod. | Dim base mm | Dim gancio mm | UM | € |
|---------|---------------|---------------|----|---|
| 0342704 | 48 x 28 x H13 | 72 x 12 | PZ | |

**Arresto a Spinta Snappy**

Chiusura a spinta Southco Snappy in Plastica rinforzata. Arresto autoregolante resistente alle vibrazioni.

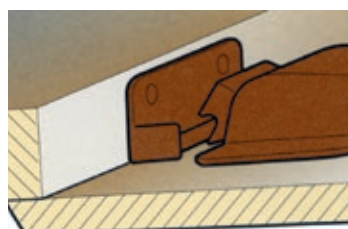

| Cod. | Dim mm | UM | € |
|---------|---------|----|---|
| 0342710 | 37 x 38 | PZ | |

**- ARRESTI FERMA PORTE E PORTELLI -****Arresto Magnetico Mag-PF3**

Ferma porte e portelli magnetico in plastica bianca con piastrina. Composto da due parti che si montano separatamente sulla parte fissa e sulla parte mobile. Venduto in coppia.

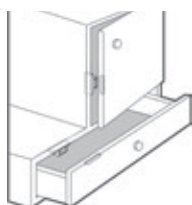

| Cod. | Dim mm | UM | € |
|---------|---------------|----|---|
| 0342702 | 45 x 16 x H13 | CP | |

**Arresto Magnetico Mag-PF2**

Ferma porte e portelli magnetico in plastica bianca con rondella. Composto da due parti che si montano separatamente sulla parte fissa e sulla parte mobile. Venduto in coppia.

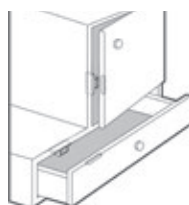

| Cod. | Dim mm | UM | € |
|---------|---------------|----|---|
| 0342701 | 35 x 22 x H18 | CP | |

**Arresto Magnetico Mag-PF3 Inox**

Ferma porte e portelli magnetico in Acciaio Inox con piastrina. Composto da due parti che si montano separatamente sulla parte fissa e sulla parte mobile.

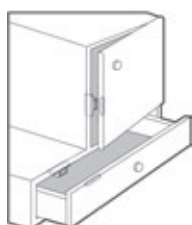

| Cod. | Dim mm | UM | € |
|---------|---------------|----|---|
| 0342706 | 53 x 22 x H14 | PZ | |

**Arresto Magnetico Mag-PF1**

Ferma porte e portelli magnetico a calamita. Composto da due parti: una viene montata esternamente, la seconda va incassata. Guscio in Plastica rinforzata. Tenuta 2,5 Kg.



| Cod. | L mm | L1 mm | H mm | H1 mm | UM | € |
|---------|------|-------|------|-------|----|---|
| 0336120 | 62 | 46 | 15 | 10 | PZ | |



Fermaporte Magnetico Mag1

Ferma porte e portelli magnetico a calamita. Composto da due parti: la prima con base a staffa va montata a pavimento, la seconda va montata sulla porta. Guscio in Ottone Cromato.



| Cod. | Dim mm | UM | € |
|----------------|------------|----|---|
| 0336102 | ø 39 x H40 | PZ | |

**Fermaporte Magnetico Mag0**

Ferma porte e portelli magnetico a calamita in Ottone Cromato con magneti orientabile fino a 20°. Composto da due parti: la prima viene montata esternamente, la seconda va incassata.



| Cod. | Dim mm | UM | € |
|----------------|------------|----|---|
| 0336101 | ø 39 x H26 | PZ | |

**Fermaporte Magnetico Mag4**

Ferma porte e portelli magnetico in Acciaio Inox satinato. Composto da due parti che si montano separatamente sulla parte fissa e sulla parte mobile. Fissaggio con base adesiva 3M oppure con viti incluse.



| Cod. | Dim mm | UM | € |
|----------------|------------|----|---|
| 0336405 | ø 60 x H28 | PZ | |

**Fermaporte Stopper Inox**

Fermaporte classico a sfera in Acciaio Inox Cromato con inserto in gomma. Montaggio a pavimento con base adesiva 3M oppure con vite inclusa.



| Cod. | Dim mm | UM | € |
|----------------|------------|----|---|
| 0336404 | ø 44 x H23 | PZ | |

**Fermaporte Magnetico Mag3**

Ferma porte e portelli magnetico a calamita in Acciaio Inox. Composto da due parti: la prima con base a staffa va montata a pavimento, la seconda va montata sulla porta.



| Cod. | A mm | B mm | C mm | D mm | E mm | UM | € |
|----------------|------|------|------|------|------|----|---|
| 0336105 | 42 | 38 | 18 | 15 | 47 | PZ | |

**Fermaporte Magnetico Mag2**

Ferma porte e portelli magnetico a calamita in Ottone Cromato con corpo orientabile fino a 20°. Completo di piastrina di riscontro.



| Cod. | Dim mm | UM | € |
|----------------|------------|----|---|
| 0336107 | ø 39 x H70 | PZ | |

**Fermaporte a Gancio**

Fermaporte a gancio in Ottone Cromato.



| Cod. | A mm | B mm | UM | € |
|----------------|------|------|----|---|
| 0336435 | 40 | 35 | PZ | |
| 0336445 | 50 | 45 | PZ | |

**Fermaporte Stopper Rubber**

Ferma porte classico a cuneo in gomma con manico in Acciaio Inox.



| Cod. | Dim mm | UM | € |
|----------------|----------------|----|---|
| 0336400 | 124 x 50 x H32 | PZ | |

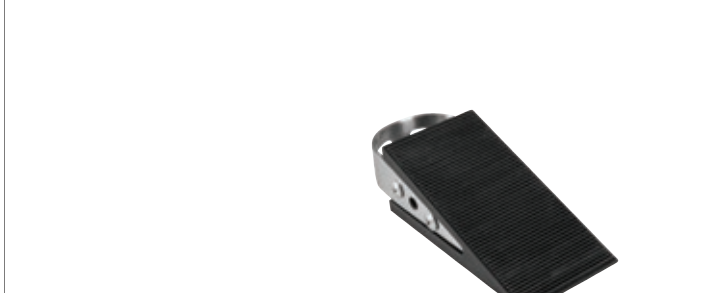

Chiusura a Spinta JF

Chiusura a spinta per portelli e paglioli completa di scontro e viteria. Corpo in Nylon con montaggio a incasso.



| Cod. | Ø Foro mm | Ø Esterno mm | D mm | Colore | Chiavi | UM | € |
|----------------|-----------|--------------|-------|--------|--------|----|---|
| 0342227 | 50 | 61 | 2<>14 | BIANCO | No | PZ | |
| 0342225 | 50 | 61 | 2<>14 | BIANCO | Si | PZ | |
| 0342228 | 50 | 61 | 2<>14 | NERO | No | PZ | |



Chiusura a Spinta Southco

Chiusura a spinta Southco per portelli e paglioli, montaggio a incasso. Corpo in Resina rinforzata.



| Cod. | Ø Foro mm | Ø Esterno mm | D mm | Chiavi | UM | € |
|----------------|-----------|--------------|-------|--------|----|---|
| 0342244 | 50 | 60 | 6<>12 | No | PZ | |
| 0342246 | 50 | 60 | 6<>12 | Si | PZ | |



Chiusura a Spinta SS

Chiusura a spinta per portelli e paglioli, montaggio a incasso. Corpo in Acciaio Inox lucidato a specchio.



| Cod. | Ø Foro mm | Ø Esterno mm | D mm | Chiavi | UM | € |
|----------------|-----------|--------------|-------|--------|----|---|
| 0342233 | 50 | 60 | 6<>12 | No | PZ | |
| 0342234 | 50 | 60 | 6<>12 | Si | PZ | |



Chiusura a Spinta SS Evo

Chiusura a spinta per portelli e paglioli con ampia maniglia per una presa più comoda. Corpo in Acciaio Inox lucidato a specchio, montaggio a incasso con guarnizione stagna.



| Cod. | Ref | Dim foro mm | Dim esterne mm | D mm | UM | € |
|----------------|----------|-------------|----------------|-------|----|---|
| 0342250 | Tonda | Ø 45 | Ø 57 | 9<>22 | PZ | |
| 0342252 | Quadrata | Ø 45 | 57 x 57 | 9<>22 | PZ | |



Chiusura a Spinta Roca

Chiusura a spinta Roca per portelli e paglioli con montaggio a incasso. Corpo in Acciaio Inox AISI 316 lucidato a specchio con componenti antivibranti.



| Cod. | Ø Foro mm | Ø Esterno mm | D mm | UM | € |
|----------------|-----------|--------------|-------|----|---|
| 0342262 | 50 | 61 | 2<>22 | PZ | |



FERRAMENTA/CHIUSURE/VITERIA

2

Chiusura a Compressione SS1

Chiusura a compressione in Acciaio Inox 316 con tavella regolabile. Per aprire e chiudere paglioli e boccaporti. Completa di tavella dritta e angolata che può essere montata in posizione normale oppure girata (Rev) per coprire tutti gli spessori (A) richiesti.



| Cod. | C mm | C1 mm | D mm | A mm | T mm | UM | € |
|----------------|------|-------|------|---------------------|--------|----|---|
| 0341009 | 64 | 50 | 62 | 20<>40 (45<>60 Rev) | 10<>20 | PZ | |

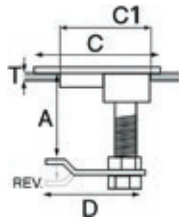

Chiusura a Compressione SS

Chiusura a compressione in Acciaio Inox 316 con tavella regolabile. Per aprire e chiudere paglioli e boccaporti. La tavella può essere montata in posizione normale oppure girata (Rev) per coprire tutti gli spessori (A) richiesti.



| Cod. | Chiavi | C mm | C1 mm | D mm | A mm | T mm | UM | € |
|----------------|--------|------|-------|------|---------------------|--------|----|---|
| 0341002 | No | 64 | 50 | 62 | 20<>40 (45<>60 Rev) | 10<>20 | PZ | |
| 0341012 | Si | 64 | 50 | 62 | 20<>40 (45<>60 Rev) | 10<>20 | PZ | |

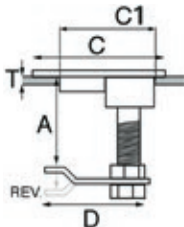

Chiusura a Compressione Southco M1-20

Chiusura a compressione Southco stagna IP65 in Acciaio Inox di qualità superiore con tavella regolabile. Per aprire e chiudere paglioli e boccaporti. La tavella può essere montata in posizione normale oppure girata (Rev) per coprire tutti gli spessori (A) richiesti.



| Cod. | Chiavi | C mm | C1 mm | A mm | T mm | UM | € |
|----------------|--------|------|-------|---------------------|----------|----|---|
| 0341133 | No | 61,5 | 50 | 27<>40 (51<>64 Rev) | 12<>22,5 | PZ | |
| 0341134 | Si | 61,5 | 50 | 27<>40 (51<>64 Rev) | 12<>22,5 | PZ | |

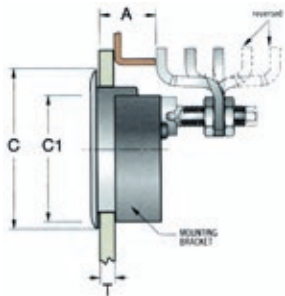

Chiusura a Compressione Southco M1-25

Chiusura a compressione Southco stagna IP65 in Acciaio Inox di qualità superiore con tavella regolabile. Per aprire e chiudere paglioli e boccaporti. La tavella può essere montata in posizione normale oppure girata (Rev) per coprire tutti gli spessori (A) richiesti.



| Cod. | Chiavi | C mm | C1 mm | A mm | T mm | UM | € |
|----------------|--------|------|-------|---------------------|----------|----|---|
| 0341153 | No | 76 | 63,5 | 34<>48 (60<>75 Rev) | 12<>22,5 | PZ | |
| 0341154 | Si | 76 | 63,5 | 34<>48 (60<>75 Rev) | 12<>22,5 | PZ | |

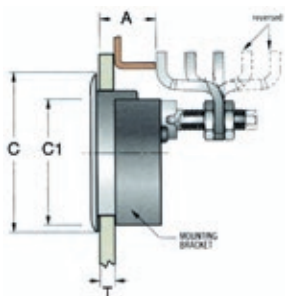



Chiusura a Compressione Roca 61

Chiusura a compressione stagna Roca in Acciaio Inox AISI 316 lucidato a specchio con tavella regolabile. Per aprire e chiudere paglioli e boccaporti. Le tavelle angolate possono essere montate in posizione normale oppure girate (Rev) per coprire tutti gli spessori (A) richiesti. Spessore portello 2<>22 mm (T).



| Cod. | Tavella | A mm | C mm | C1 mm | UM | € |
|----------------|----------|---------------------|------|-------|----|---|
| 0341060 | Angolata | 14<>40 (Rev 65<>91) | 61,5 | 50 | PZ | |
| 0341061 | Dritta | 40<>65 | 61,5 | 50 | PZ | |

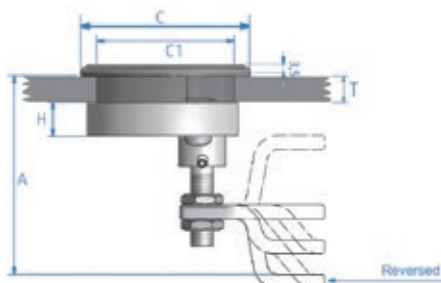

Chiusura a Compressione Roca 76

Chiusura a compressione stagna Roca in Acciaio Inox AISI 316 lucidato a specchio con tavella regolabile. Per aprire e chiudere paglioli e boccaporti. Le tavelle angolate possono essere montate in posizione normale oppure girate (Rev) per coprire tutti gli spessori (A) richiesti. Spessore portello 2<>22 mm (T).



| Cod. | Tavella | A mm | C mm | C1 mm | UM | € |
|----------------|----------|---------------------|------|-------|----|---|
| 0341062 | Angolata | 18<>44 (Rev 69<>99) | 76 | 63,5 | PZ | |
| 0341063 | Dritta | 44<>69 | 76 | 63,5 | PZ | |

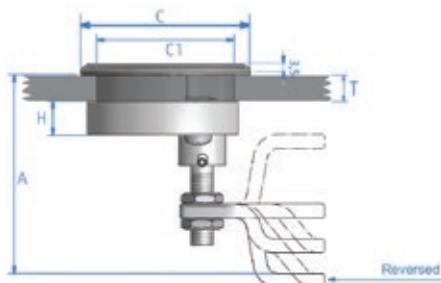

Chiusura a Compressione Roca 70T

Chiusura a compressione Roca in Acciaio Inox AISI 316 lucidato a specchio con maniglia a T e tavella regolabile. Per aprire e chiudere paglioli e boccaporti. La chiusura va completata con tavella a scelta.



| Cod. | C mm | C1 mm | Accessori | UM | € |
|----------------|------|-------|------------------------------|----|---|
| 0341030 | 70 | 62 | | PZ | |
| 0341031 | | | Tavella dritta A 47<>90 mm | PZ | |
| 0341032 | | | Tavella angolata A 27<>70 mm | PZ | |

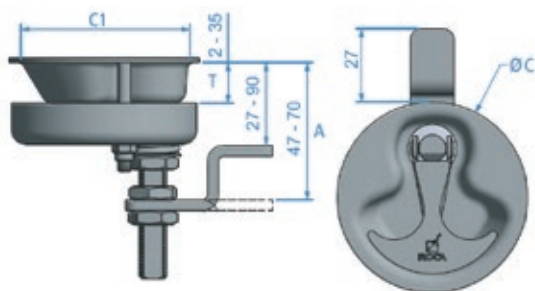

FERRAMENTA/CHIUSURE/VALERIA

2

Chiusura a Compressione R1

Chiusura a compressione tonda in Acciaio Inox con tavella regolabile. Piastra a vista senza fori vite, montaggio con viti dall'interno. Per aprire e chiudere paglioli e boccaporti.



| Cod. | C mm | C1 mm | D mm | A mm | T mm | UM | € |
|---------|------|-------|------|--------|-------|----|---|
| 0341007 | 79 | 65 | 50 | 60<>75 | 5<>25 | PZ | |

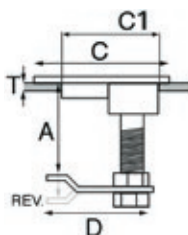

Chiusura a Compressione Q1

Chiusura a compressione rettangolare in Acciaio Inox con tavella regolabile. Piastra a vista senza fori vite, montaggio con viti dall'interno. Per aprire e chiudere paglioli e boccaporti.



| Cod. | B mm | C mm | D mm | A mm | T mm | UM | € |
|---------|------|------|------|--------|-------|----|---|
| 0341023 | 63 | 78 | 60 | 55<>75 | 8<>30 | PZ | |

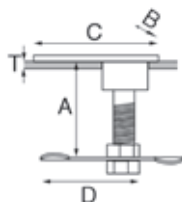

Chiusura a Compressione Q2

Chiusura a compressione rettangolare in Acciaio Inox con tavella regolabile. Piastra a vista con fori vite, montaggio con viti dall'esterno. Per aprire e chiudere paglioli e boccaporti.



| Cod. | B mm | C mm | D mm | A mm | T mm | UM | € |
|---------|------|------|------|--------|-------|----|---|
| 0341025 | 75 | 97 | 50 | 55<>75 | 8<>30 | PZ | |

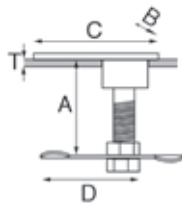

Chiusura a Compressione Q4

Chiusura a compressione in Acciaio Inox AISI316 con copertura a filo. Tavella regolabile per aprire e chiudere paglioli e boccaporti.



| Cod. | A mm | B mm | C mm | D mm | F mm | E mm | UM | € |
|---------|------|------|------|------|------|------|----|---|
| 0341020 | 110 | 115 | 91 | 51 | 75 | 15 | PZ | |

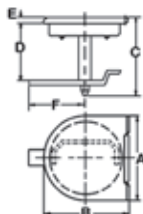

Maniglia a Incasso Inox

Maniglia a incasso in Acciaio Inox per paglioli e boccaporti.

| Cod. | Molla | Dim mm | UM | € |
|---------|-------|---------|----|---|
| 0340475 | No | 57 x 76 | PZ | |
| 0340476 | Si | 57 x 76 | PZ | |

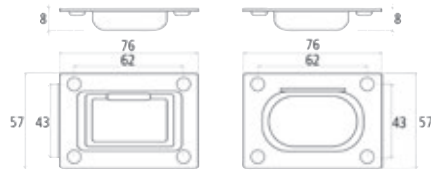

Maniglie a Incasso Inox con Molla

Maniglie alza paglioli a incasso in Acciaio Inox con molla.

| Cod. | Dim mm | UM | € |
|---------|---------|----|---|
| 0340438 | 38 x 40 | PZ | |
| 0340455 | 55 x 65 | PZ | |
| 0340456 | 57 x 76 | PZ | |



Maniglie a Incasso Inox con Molla Roca

Maniglie alza paglioli a incasso Roca in Acciaio Inox con molla lucidate a specchio di qualità e finitura superiore.

| Cod. | Dim mm | UM | € |
|---------|---------|----|---|
| 0340410 | 38 x 44 | PZ | |
| 0340411 | 50 x 60 | PZ | |

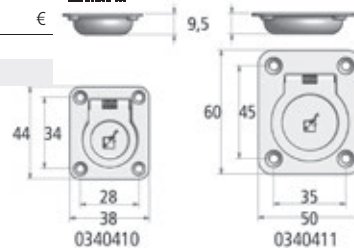

Maniglia a Incasso Inox Roca Comfort

Maniglia a incasso Roca in Acciaio Inox per paglioli e boccaporti lucidata a specchio di qualità e finitura superiore. Presa comoda e facile.

| Cod. | Dim mm | UM | € |
|---------|---------|----|---|
| 0340412 | 60 x 75 | PZ | |

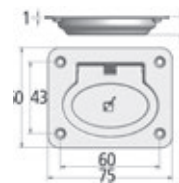

Maniglia Alza-Paglioli Inox Flush

Maniglia Alza-Paglioli a incasso tonda e quadra in Acciaio Inox.

| Cod. | Dim mm | UM | € |
|---------|---------|----|---|
| 0340481 | ∅ 50 | PZ | |
| 0340482 | 50 x 50 | PZ | |



Maniglia a Incasso Inox Ring Pull

Maniglia alza paglioli a incasso in Acciaio Inox AISI 316.

| Cod. | Dim mm | UM | € |
|---------|--------|----|---|
| 0340433 | ∅ 50 | PZ | |



Maniglia a Incasso Inox con Molla Roca Ring Pull

Maniglia Alza-Paglioli Roca a incasso con molla in Acciaio Inox lucidato a specchio di qualità e finitura superiore.

| Cod. | Dim mm | UM | € |
|---------|--------|----|---|
| 0340415 | ∅ 50 | PZ | |



FERRAMENTA/CHIUSURE/VITERIA

2

Maniglia a Incasso in Ottone BS1

Maniglia a incasso rettangolare in Ottone. Impugnatura dritta.

| Cod. | Dim mm | Finitura | UM | € |
|---------|-------------|----------------|----|---|
| 0340675 | 74 x 50 x 8 | OTTONE LUCIDO | PZ | |
| 0340676 | 74 x 50 x 8 | OTTONE CROMATO | PZ | |
| 0340696 | 92 x 63 x 9 | OTTONE LUCIDO | PZ | |
| 0340697 | 92 x 63 x 9 | OTTONE CROMATO | PZ | |

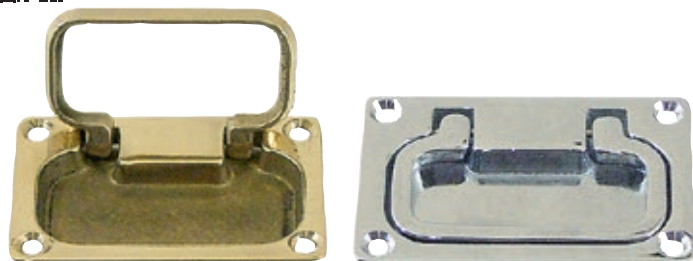

Maniglia a Incasso in Ottone BS2

Maniglia a incasso rettangolare in Ottone. Impugnatura curva.

| Cod. | Dim mm | Finitura | UM | € |
|---------|--------------|----------------|----|---|
| 0340674 | 70 x 43 x 13 | OTTONE LUCIDO | PZ | |
| 0340683 | 70 x 43 x 13 | OTTONE CROMATO | PZ | |
| 0340684 | 80 x 49 x 13 | OTTONE LUCIDO | PZ | |
| 0340685 | 80 x 49 x 13 | OTTONE CROMATO | PZ | |

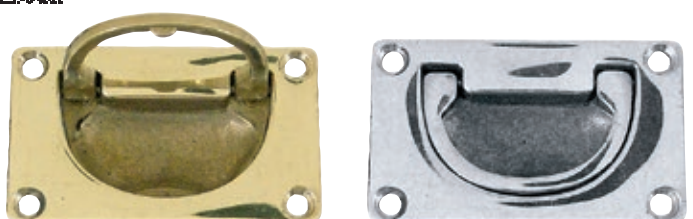

Chiusura a Incasso T Inox

Chiusura a incasso in Acciaio Inox con maniglia a T per portelli e paglioli.

| Cod. | Dim mm | UM | € |
|---------|---------|----|---|
| 0342206 | 57 x 65 | PZ | |

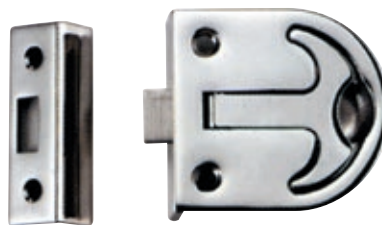

Chiusura a Incasso Inox

Chiusura a incasso per portelli e paglioli in Acciaio Inox.

| Cod. | Dim mm | UM | € |
|---------|---------|----|---|
| 0342205 | 57 x 40 | PZ | |



Maniglia a Incasso in Plastica PS1

Maniglie a incasso compatte in Plastica rinforzata.

| Cod. | Dim mm | Colore | UM | € |
|---------|---------|--------|----|---|
| 0341557 | 57 x 57 | BIANCO | PZ | |
| 0341558 | 57 x 57 | CREMA | PZ | |



Maniglia a Incasso in Plastica PS2

Maniglia a incasso in Plastica rinforzata.

| Cod. | Dim mm | UM | € |
|---------|----------|----|---|
| 4010000 | 85 x 175 | PZ | |



Maniglia Passante in Ottone

Maniglia passante in Ottone lucido oppure cromato.

| Cod. | ø mm | Finitura | UM | € |
|---------|------|----------------|----|---|
| 0341326 | 32 | OTTONE LUCIDO | PZ | |
| 0341327 | 32 | OTTONE CROMATO | PZ | |



Maniglietta Cromata S

Maniglietta di servizio in Ottone Cromato Lucido.



| Cod. | L mm | UM | € |
|----------------|------|----|---|
| 0340807 | 75 | PZ | |



Maniglia Ottone Cromato M

Maniglia in Ottone Cromato. Fissaggio dall'interno con viti da 6 mm.



| Cod. | L mm | H mm | UM | € |
|----------------|------|------|----|---|
| 0340810 | 97 | 30 | PZ | |



Maniglia Inox Lift

Maniglia di servizio in Acciaio Inox. Diametro maniglia 10 mm, foro vite da 5 mm.



| Cod. | L mm | H mm | UM | € |
|----------------|------|------|----|---|
| 0340814 | 143 | 38 | PZ | |



Maniglia Inox Grab

Maniglia in Acciaio Inox AISI 316 lucidato a specchio con presa ergonomica. Fissaggio con 2 viti M6 passanti.



| Cod. | L mm | H mm | UM | € |
|----------------|------|------|----|---|
| 0340850 | 170 | 32 | PZ | |



Marine Tools

Maniglia Inox Stud

Maniglia in Acciaio Inox lucidato a specchio. Fissaggio con 2 prigionieri da 8 mm.



| Cod. | L mm | H mm | UM | € |
|----------------|------|------|----|---|
| 0340819 | 170 | 40 | PZ | |



Maniglia Inox HD Screw

Maniglia in Acciaio Inox lucidato a specchio. Fissaggio con 2 viti passanti.



| Cod. | L mm | H mm | UM | € |
|----------------|------|------|----|---|
| 0340818 | 170 | 40 | PZ | |



Maniglia Corta in Plastica

Maniglie corte (14 cm) in Plastica rinforzata. Montaggio con viti a vista.



| Cod. | L mm | H mm | Colore | UM | € |
|----------------|------|------|--------|----|---|
| 0340710 | 140 | 40 | GRIGIO | PZ | |
| 0340711 | 140 | 40 | NERO | PZ | |
| 0340712 | 140 | 40 | BIANCO | PZ | |



Maniglie Sidney Corte in PVC

Maniglie corte (20 cm) in morbido PVC con anima rinforzata. Montaggio con viti passanti a scomparsa.



| Cod. | L mm | H mm | Colore | UM | € |
|----------------|------|------|--------------------|----|---|
| 0340724 | 205 | 55 | GRIGIO SCURO 7046 | PZ | |
| 0340726 | 205 | 55 | GRIGIO CHIARO 7035 | PZ | |



Pomoli Globe

Pomoli in Ottone Cromato per portelli e cassetti.



| Cod. | ø mm x H mm | UM | € |
|----------------|-------------|----|---|
| 0340922 | 15 x 20 | PZ | |



Pomolo Double-Cone

Pomolo in Ottone Cromato per portelli e cassetti.



| Cod. | ø mm x H mm | UM | € |
|----------------|-------------|----|---|
| 0340912 | 23 x 18 | PZ | |



FERRAMENTA/CHIUSURE/VITERIA

2

Chiusura a Farfalla

Chiusura a farfalla in Ottone Cromato per portelli e oblò. Dimensioni base con farfalla: 38 x 15 mm. Interasse fori 26 mm. Dimensioni scontro: 40 x 22 mm. Interasse fori 10 mm.



| Cod. | mm | UM | € |
|---------|---------|----|---|
| 0343100 | 40 x 38 | PZ | |



Chiusura Piana a Leva

Chiusura piana a leva in Ottone Cromato.



| Cod. | mm | UM | € |
|---------|---------|----|---|
| 0343001 | 70 x 35 | PZ | |



Chiusura Verticale a Leva

Chiusura verticale a leva in Ottone Cromato.



| Cod. | mm | UM | € |
|---------|---------|----|---|
| 0343002 | 70 x 35 | PZ | |



Chiusura Porta Lucchetto Standard

Chiusura porta lucchetto a leva in Acciaio Inox.



| Cod. | mm | UM | € |
|---------|----------|----|---|
| 0343013 | 100 x 45 | PZ | |



Chiusura Porta Lucchetto a Leva Reverse

Chiusura porta lucchetto a leva in Ottone Cromato.



| Cod. | mm | UM | € |
|---------|----------|----|---|
| 0343003 | 100 x 45 | PZ | |

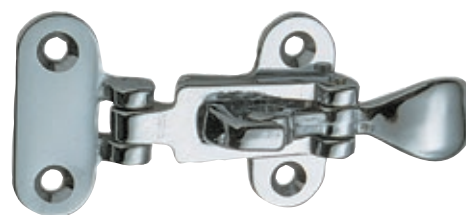

Chiusura Porta Lucchetto Regolabile

Chiusura porta lucchetto a leva regolabile in Acciaio Inox.



| Cod. | mm | UM | € |
|---------|----------|----|---|
| 0343006 | 66<>75 | PZ | |
| 0343007 | 115<>125 | PZ | |



Chiusura Porta Lucchetto Classica a Ribalta Inox

Chiusura porta lucchetto classica a ribalta in Acciaio Inox.



| Cod. | mm | UM | € |
|---------|---------|----|---|
| 0342034 | 72 x 34 | PZ | |



Chiusura Porta Lucchetto Occhio Fisso Inox

Chiusura porta lucchetto a ribalta in Acciaio Inox.

| Cod. | mm | UM | € |
|---------|---------|----|---|
| 0342028 | 71 x 28 | PZ | |



Chiusura Porta Lucchetto Occhio Girevole Inox

Chiusura porta lucchetto a ribalta con occhio girevole in Acciaio Inox.

| Cod. | mm | UM | € |
|---------|---------|----|---|
| 0342029 | 69 x 30 | PZ | |



Chiusura Porta Lucchetto Piana Inox

Chiusura porta lucchetto piana a leva in Acciaio Inox.

| Cod. | mm | UM | € |
|---------|----------|----|---|
| 0343011 | 100 x 30 | PZ | |

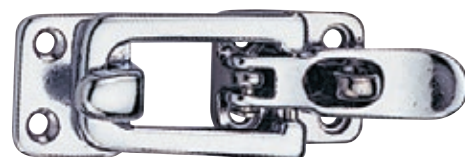

Chiusura Porta Lucchetto Verticale Inox

Chiusura porta lucchetto verticale a leva in Acciaio Inox.

| Cod. | mm | UM | € |
|---------|----------|----|---|
| 0343012 | 100 x 30 | PZ | |



Chiusura Porta Lucchetto a Leva Extra Ottone Cromato

Chiusura porta lucchetto a leva in Ottone Cromato con fori vite nascosti.

| Cod. | mm | UM | € |
|---------|---------|----|---|
| 0343004 | 82 x 30 | PZ | |



Chiusura Porta Lucchetto Doppia Ribalta Ottone Cromato

Chiusura porta lucchetto doppia ribalta in Ottone Cromato.

| Cod. | mm | UM | € |
|---------|----------|----|---|
| 0342035 | 150 x 35 | PZ | |



Chiusura a Ribalta con Serratura Inox

Chiusura a ribalta in Acciaio Inox con serratura e chiavi.

| Cod. | mm | UM | € |
|---------|---------|----|---|
| 0342200 | 76 x 34 | PZ | |



Chiusura a Leva Classic Inox

Chiusura a leva in Acciaio Inox AISI 316 ideale per portelli, cassoni e ghiacciaie.

| Cod. | Dim mm | UM | € |
|---------|----------|----|---|
| 0343009 | 115 x 16 | PZ | |



Chiusura a Leva Classic Compact Inox

Chiusura a leva in Acciaio Inox AISI 316 ideale per portelli, cassoni e ghiacciaie.

| Cod. | Dim mm | UM | € |
|---------|---------|----|---|
| 0343018 | 55 x 23 | PZ | |



Chiusura a Leva Classic Wide Inox

Chiusura a leva in Acciaio Inox AISI 316 ideale per portelli, cassoni e ghiacciaie.

| Cod. | Dim mm | UM | € |
|---------|---------|----|---|
| 0343014 | 52 x 42 | PZ | |



Chiusura a Leva Roca Safelock

Chiusura a leva Roca in Acciaio Inox AISI 316 lucidato a specchio oppure in Acciaio Inox Nero. Completamente coperta per evitare danni a cose e persone, ideale per portelli, cassoni e ghiacciaie.

| Cod. | Acciaio Inox | Dim mm | UM | € |
|---------|--------------|----------|----|---|
| 0343025 | Lucido | 93 x 23 | PZ | |
| 0343035 | Nero | 93 x 23 | PZ | |
| 0343026 | Lucido | 145 x 31 | PZ | |



Chiusura Amortizzata Soft Latch Inox

Chiusura in Elastomero Termoplastico amortizzato per portelli e cassoni. Rivetto, aggancio, supporto e spine in Acciaio Inox.

| Cod. | L Agganciata mm | L Sganciata mm | Colore | UM | € |
|---------|-----------------|----------------|--------|----|---|
| 0343015 | 105 | 97,5 | NERO | PZ | |
| 0343016 | 105 | 97,5 | BIANCO | PZ | |



Chiusura a Leva Southco F7

Chiusura flessibile in elastomero termoplastico resistente raggi UV che assorbe e riduce le vibrazioni. Ideale per portelli, cassoni e ghiacciaie.

| Cod. | A mm | B mm | C mm | D mm | UM | € |
|---------|------|------|------|------|----|---|
| 0343020 | 112 | 62 | 25 | 19 | PZ | |



Chiusura a Leva Roca Soft

Chiusura a leva Roca in elastomero termoplastico con componenti antigelo e base di attacco in Acciaio Inox. Ideale per portelli, cassoni e ghiacciaie.

| Cod. | Dim mm | UM | € |
|---------|----------|----|---|
| 0343028 | 130 x 34 | PZ | |



Chiusura a Pulsante Southco Push/Pull

Chiusura a spinta Southco con apertura a trazione: per aprire si tira il pomello, per chiudere si spinge la porta. Il pomello si richiude a filo e fuoriesce con un semplice tocco. Corpo in PC/ABS resistente alla corrosione e raggi UV. Spessore porta 1,5<->19 mm.



southco

| Cod. | Foro ø mm | L mm | Spessore porta mm | Finitura | UM | € |
|---------|-----------|------|-------------------|----------|----|---|
| 0343250 | 32 | 47 | 1,5<->19 | CROMATA | PZ | |

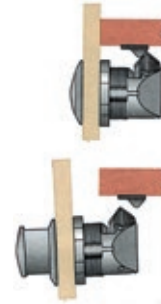

Chiusura a Spinta Southco Push/Twist

Chiusura a spinta Southco con pomello girevole: il pomello rimane a filo quando chiuso, ma fuoriesce con un semplice tocco in modo da fornire una presa sicura per chiudere e aprire la porta. Ruotare il pomello per aprire, spingere la porta per chiudere. Nottolino a regolazione automatica. Corpo e dado in PC/ABS anti-corrosione. Per porte a filo o sporgenti.



southco

| Cod. | Foro ø mm | L mm | Spessore porta mm | Finitura | Per Porte | UM | € |
|---------|-----------|------|-------------------|----------|-----------|----|---|
| 0343245 | 32 | 47 | 1,5<->19 | CROMATA | a filo | PZ | |
| 0343246 | 32 | 47 | 1,5<->19 | CROMATA | a battuta | PZ | |

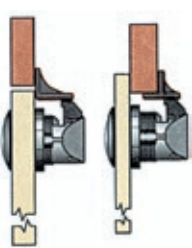

Chiusura a Spinta Southco Point R

Chiusura a spinta Southco con pulsante a filo e flangia tonda. Il pulsante a scatto rimane a filo in posizione chiusa e fuoriesce in posizione aperta. Corpo e dado in Nylon Nero, flangia e pomello in Ottone. Da completare con un aggancio fisso o regolabile.



southco

| Cod. | Foro ø mm | L mm | Spessore porta mm | Finitura | Aggancio | UM | € |
|---------|-----------|------|-------------------|----------|------------|----|---|
| 0343260 | 25 | 50 | 4<->25,4 | CROMATA | | PZ | |
| 0343261 | 25 | 50 | 4<->25,4 | SATINATA | | PZ | |
| 0343271 | | | | | Fisso | PZ | |
| 0343272 | | | | | Regolabile | PZ | |

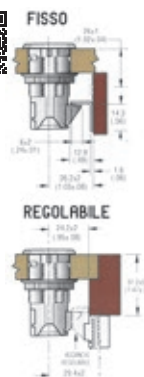

Chiusura a Spinta Southco Point Q

Chiusura a spinta Southco con pulsante a filo e flangia quadra. Il pulsante a scatto rimane a filo in posizione chiusa e fuoriesce in posizione aperta. Corpo e dado in Nylon Nero, flangia e pomello in Ottone. Da completare con un aggancio fisso o regolabile.



southco

| Cod. | Foro ø mm | L mm | Spessore porta mm | Finitura | Aggancio | UM | € |
|---------|-----------|------|-------------------|----------|------------|----|---|
| 0343265 | 25 | 50 | 4<->25,4 | CROMATA | | PZ | |
| 0343266 | 25 | 50 | 4<->25,4 | SATINATA | | PZ | |
| 0343271 | | | | | Fisso | PZ | |
| 0343272 | | | | | Regolabile | PZ | |

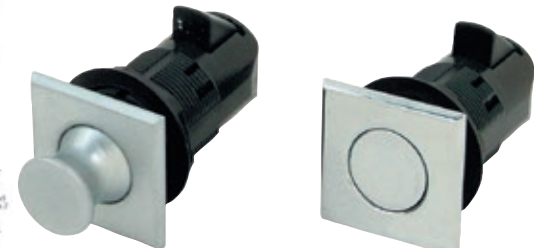
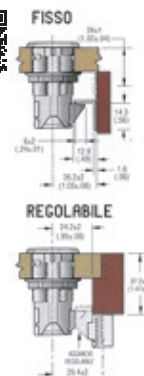

Chiusura a Spinta Novibra

Chiusura a spinta Novibra per porte, portelli, gavoni, cassetti ed altre applicazioni simili. Facile e veloce da installare, elimina i rumori causati dalle vibrazioni del motore. Parte a vista impermeabile, corpo in PC/ABS resistente alla corrosione e raggi UV.



southco

| Cod. | Foro ø | L mm | Spessore porta | Piatto | Maniglia | UM | € |
|---------|--------|------|----------------|----------|----------|----|---|
| 0343254 | 38 mm | 44,5 | 3<->22 mm | SATINATO | SATINATA | PZ | |
| 0343255 | 38 mm | 44,5 | 3<->22 mm | CROMATO | CROMATA | PZ | |
| 0343256 | 38 mm | 44,5 | 3<->22 mm | BIANCO | BIANCA | PZ | |
| 0343259 | 38 mm | 44,5 | 3<->22 mm | NERO | NERA | PZ | |



FERRAMENTA/CHIUSURE/VITERIA

2

Chiusura a Spinta JF Push/Twist Knob

Chiusura a spinta con pomello cromato e corpo in ABS. Completa con scontro inox e viteria. Il pomello rimane a filo in posizione chiusa e fuoriesce con un semplice tocco per fornire una presa sicura per chiudere e aprire la porta. Si ruota il pomello per aprire, si spinge la porta per chiudere.

| Cod. | Ø Foro mm | Spessore porta mm | UM | € |
|---------|-----------|-------------------|----|---|
| 0343242 | 30 | 1<>22 | PZ | |

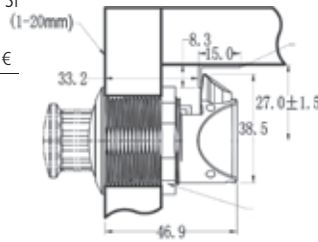

Chiusura a Spinta JF Turn

Chiusura a spinta per porte, portelli, gavoni e cassette. Corpo in ABS rinforzato, installazione facile, completa di scontro e viteria.

| Cod. | Ø Foro mm | Ø Esterno mm | Spessore porta mm | UM | € |
|---------|-----------|--------------|-------------------|----|---|
| 0343290 | 43 | 49 | 1<>20 | PZ | |

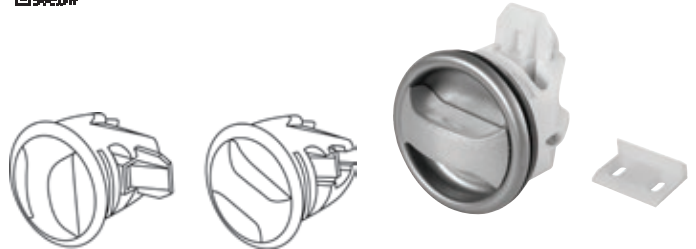
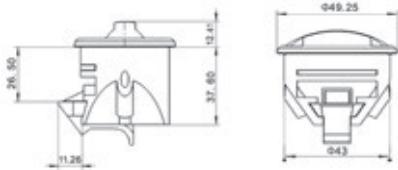

Chiusura a Pulsante JF Compact

Chiusura a pulsante per portelli e cassette completa di scontro e viteria. Cassa in ABS, pulsante cromato e parti meccaniche in lega Zamac. Dimensioni 35 x 48 mm.

| Cod. | Ø Foro mm | Spessore porta mm | UM | € |
|---------|-----------|-------------------|----|---|
| 0343140 | 20 | 10<>20 | PZ | |

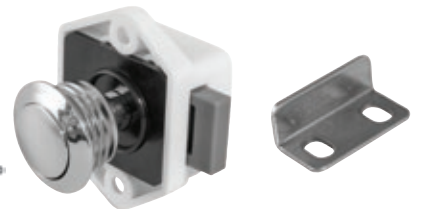
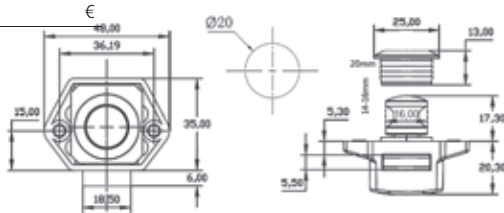

Chiusura a Pulsante JF

Chiusura a pulsante per portelli e cassette completa di scontro e viteria. Cassa in ABS, pulsante cromato e parti meccaniche in lega Zamac. Dimensioni 45 x 78 mm.

| Cod. | Ø Foro mm | Spessore porta mm | UM | € |
|---------|-----------|-------------------|----|---|
| 0343144 | 26 | 12<>22 | PZ | |

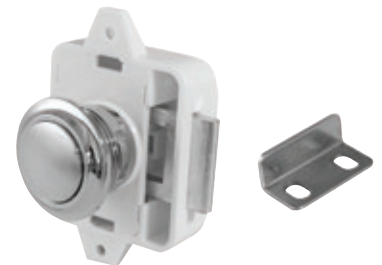
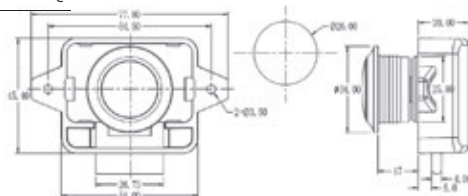

Chiusura a Pulsante F&S Compact

Chiusura a pulsante F&S per portelli e cassette. Pulsante in Ottone Cromato, cassa in Plastica Bianca. Dimensioni 50 x 35 mm.

| Cod. | Ø Foro mm | Spessore porta mm | UM | € |
|---------|-----------|-------------------|----|---|
| 0343113 | 15 | >13< | PZ | |
| 0343116 | 15 | >16< | PZ | |
| 0343119 | 15 | >19< | PZ | |

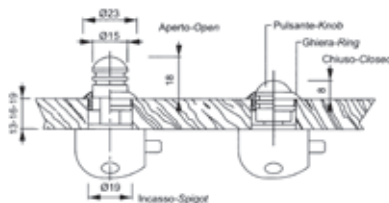

Chiusura a Pulsante F&S Std

Chiusura F&S in Plastica con pulsanti in Ottone Cromato per portelli e cassette. Da completare con pulsante a scelta. Dimensioni cassa serratura 70 x 50 mm.

| Cod. | Serratura | Pulsante | UM | € |
|---------|-----------|------------------------------|----|---|
| 0343230 | BIANCA | | PZ | |
| 0343231 | CROMATA | | PZ | |
| 0343213 | | Ø 23 mm per portelli >13< mm | PZ | |
| 0343216 | | Ø 23 mm per portelli >16< mm | PZ | |
| 0343219 | | Ø 23 mm per portelli >19< mm | PZ | |
| 0343222 | | Ø 23 mm per portelli >23< mm | PZ | |



Serratura a Pulsante JF

Serratura a pulsante in Nylon caricato con doppia chiave. Completa con rondella di fissaggio e scontro in Acciaio Inox.



| Cod. | Ø Foro mm | L mm | Spessore porta mm | UM | € |
|---------|-----------|------|-------------------|----|---|
| 0343282 | 25 | 42 | 1<>12 | PZ | |

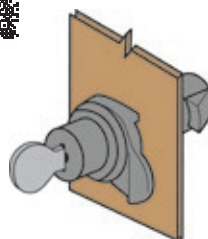

MTM

Serratura a Pulsante Southco

Serratura a pulsante Southco in Resina rinforzata con fibre di Nylon. Resistente alla corrosione, molle interne in Acciaio Inox 302. Spessore porta max 12,5 mm.



| Cod. | Ø Foro mm | L mm | Spessore porta mm | UM | € |
|---------|-----------|------|-------------------|----|---|
| 0343284 | 25 | 40 | 1,5<>12,5 | PZ | |

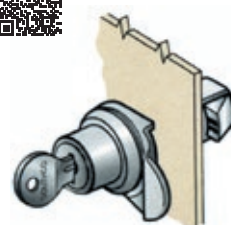
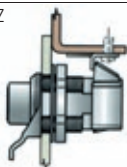

southco

Chiusura a Tavella con Chiave

Chiusura a tavella in Ottone Cromato con chiave quadrata per gavoni, portelli e paglioli.



| Cod. | Ref | Dim mm | UM | € |
|---------|----------|---------|----|---|
| 0343301 | Destra | 80 x 25 | PZ | |
| 0343302 | Sinistra | 80 x 25 | PZ | |



Mini Nottolino con Chiavi

Mini nottolino con chiusura a perno e chiavi. Perno in lega ottonata e ghiera in Acciaio Inox.



| Cod. | M mm | H mm | UM | € |
|---------|------|------|----|---|
| 0343308 | 12 | 10 | PZ | |

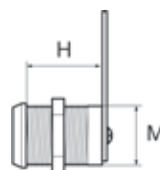

Nottolino a Tavella con Chiavi

Nottolino a tavella con doppia chiave. Corpo cromato in lega ottonata con tavella in Acciaio cromato.



| Cod. | M mm | H mm | UM | € |
|---------|------|------|----|---|
| 0343316 | 19 | 16 | PZ | |
| 0343320 | 19 | 20 | PZ | |
| 0343325 | 19 | 25 | PZ | |
| 0343330 | 19 | 30 | PZ | |

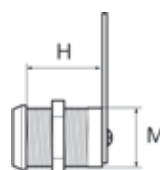

Serratura Compact Eco

Serratura compatta in lega cromata per cassette, porte e portelli, completa di doppia chiave.



| Cod. | Dim mm | Ø Foro mm | Spessore porta mm | UM | € |
|---------|--------------|-----------|-------------------|----|---|
| 0343340 | 40 x 40 x H7 | 19 | 2<>16 | PZ | |



Serratura a Incasso con Maniglia

Cornice in Acciaio Inox per portelli e paglioli. Da completare con serratura a tavella e chiavi.



| Cod. | Dim mm | Accessori | UM | € |
|---------|---------|------------------|----|---|
| 0342202 | 50 x 55 | | PZ | |
| 0343316 | | Serratura H16 mm | PZ | |
| 0343320 | | Serratura H20 mm | PZ | |
| 0343325 | | Serratura H25 mm | PZ | |
| 0343330 | | Serratura H30 mm | PZ | |



FERRAMENTA/CHIUSURE/VITERIA

2

Serratura da Accostare con Pomolo 3.656P

Serratura da accostare con chiavi, cilindro di sicurezza, scontro piano e pomolo per aprire dall'interno. Corpo in Ottone Cromato e componenti inossidabili. Mano universale DX/SX. Interasse fori 83 x 36 mm.

| Cod. | mm | D mm | H mm | UM | € |
|----------------|---------|------|------|----|---|
| 0343362 | 98 x 58 | 20 | 25 | PZ | |
| 0343363 | 98 x 58 | 20 | 30 | PZ | |

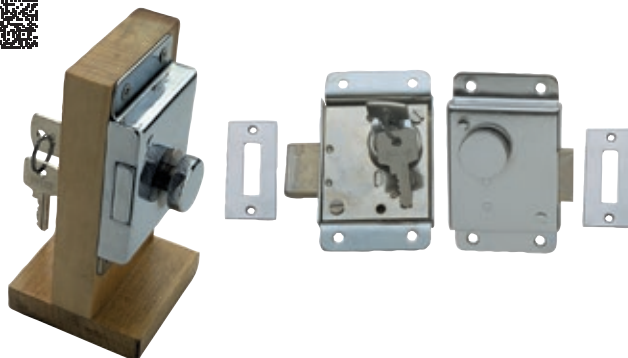
**Serratura da Accostare con Pomolo 3.656B**

Serratura da accostare con chiavi, cilindro di sicurezza, scontro a cassetta e pomolo per aprire dall'interno. Corpo in Ottone Cromato e componenti inossidabili. Mano universale DX/SX.

| Cod. | mm | D mm | H mm | UM | € |
|----------------|---------|------|------|----|---|
| 0343360 | 98 x 58 | 20 | 25 | PZ | |
| 0343361 | 98 x 58 | 20 | 30 | PZ | |

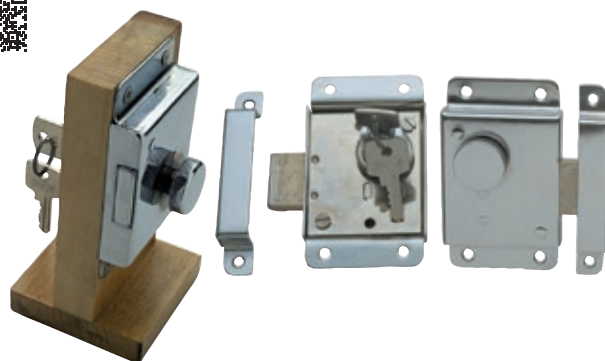
**Serratura da Accostare 4.062P**

Serratura da accostare con chiavi e scontro piano. Corpo in Ottone Cromato, componenti inossidabili. Maniglie da ordinare a parte.

| Cod. | mm | Mano | UM | € |
|----------------|----------|------|----|---|
| 0343382 | 112 x 46 | DX | PZ | |
| 0343372 | 112 x 46 | SX | PZ | |

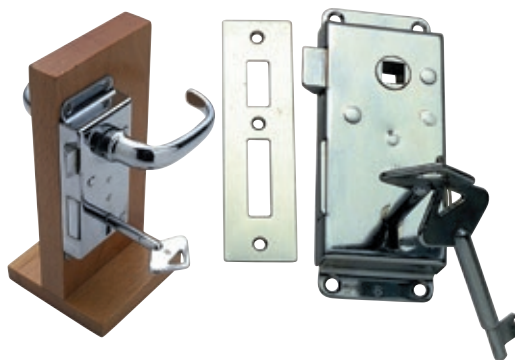
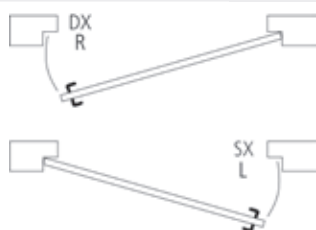
**Serratura da Accostare 4.062B**

Serratura da accostare con chiavi e scontro a cassetta. Corpo in Ottone Cromato, componenti inossidabili. Maniglie da ordinare a parte.

| Cod. | mm | Mano | UM | € |
|----------------|----------|------|----|---|
| 0343378 | 112 x 46 | DX | PZ | |
| 0343379 | 112 x 46 | SX | PZ | |

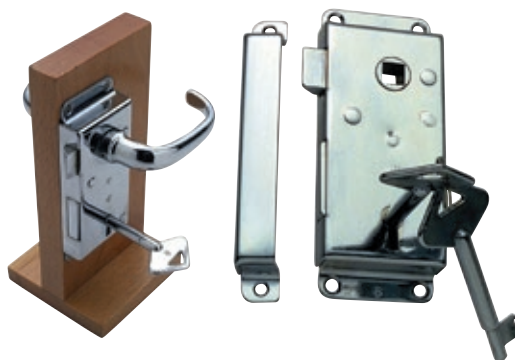
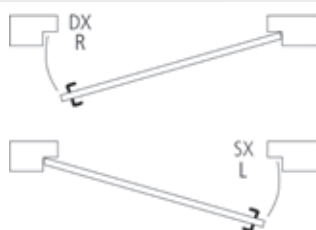
**Serratura da Infilare 4.021**

Serratura da infilare con chiavi e scontro piano. Corpo in Ottone Cromato, componenti inossidabili. Maniglie da ordinare a parte.

| Cod. | mm | Mostrina mm | Quadro maniglia | Mano | UM | € |
|----------------|--------------|-------------|-----------------|------|----|---|
| 0343381 | 93 x 44 >12< | 133 x 15 | 8 x 8 mm | DX | PZ | |
| 0343371 | 93 x 44 >12< | 133 x 15 | 8 x 8 mm | SX | PZ | |

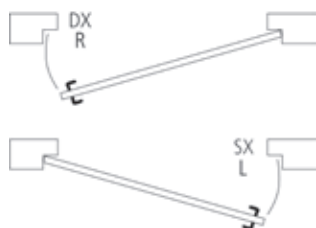

Serratura Inox Privacy Door Latch con Chiavi

Serratura in Inox Privacy con chiavi ideale per porte, portelli e gavoni. Completa di blocco privacy interno. Corpo e componenti in Acciaio Inox AISI316 e Nylon. Lo scontro va acquistato separatamente. Spessore porta 17<>22 mm.



| Cod. | Mano | Accessori | UM | € |
|---------|------|-----------|----|---|
| 0343310 | SX | | PZ | |
| 0343311 | DX | | PZ | |
| 0343312 | | Scontro | PZ | |



Esterno
External

Interno
Internal

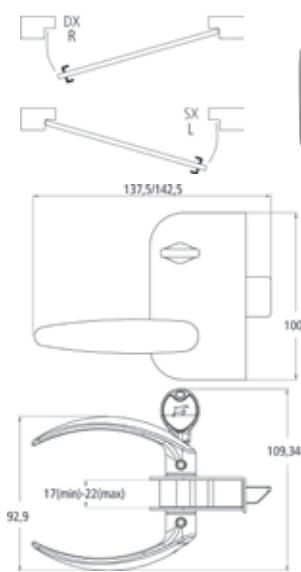

Serratura da Infilare 2.035

Serratura da infilare con chiavi, maniglie e scontro piano incassato. Corpo in Ottone Cromato, componenti inossidabili e scivolo antivibrante.



| Cod. | mm | Mostrina mm | Quadro maniglia | Mano | UM | € |
|---------|---------------|-------------|-----------------|------|----|---|
| 0343385 | 163 x 75 >13< | 212 x 22 | 9 x 9 mm | DX | PZ | |
| 0343375 | 163 x 75 >13< | 212 x 22 | 9 x 9 mm | SX | PZ | |

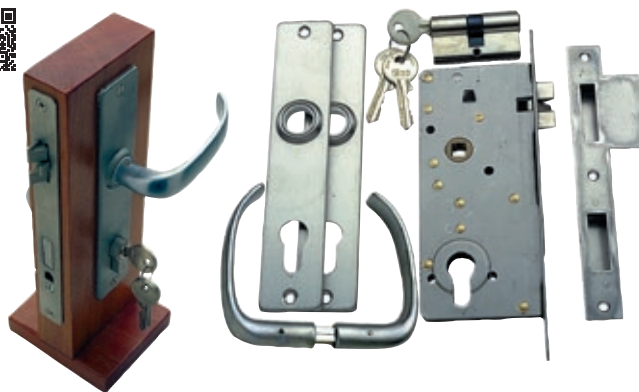
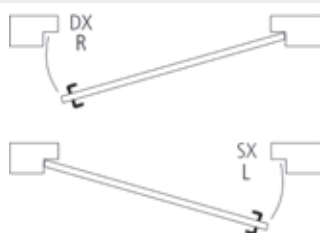

- SERRATURE CON BLOCCO (PRIVACY) -

Serratura da Accostare con Blocco Interno 3.656

Serratura da accostare con blocco di privacy interno e scontro a cassetta oppure piano. Corpo in Ottone Cromato con componenti inossidabili. Mano universale DX/SX. Maniglie da ordinare a parte.

| Cod. | mm | Scontro | UM | € |
|---------|---------|------------|----|---|
| 0343391 | 72 x 46 | a Cassetto | PZ | |
| 0343491 | 72 x 46 | Piano | PZ | |

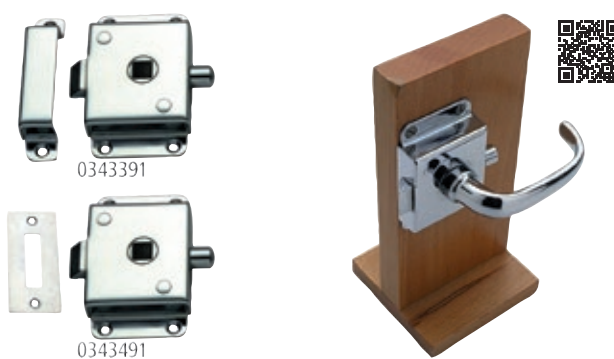

Set Serratura da Infilare con Blocco Interno 70.1500

Set serratura da infilare con blocco di privacy interno e scontro antivibrante piano. Corpo in Ottone Cromato. Componenti inossidabili. Completa di maniglie e placche.



| Cod. | mm | Mano | UM | € |
|---------|-------------|------|----|---|
| 0343392 | 68 x 60 >9< | DX | PZ | |
| 0343393 | 68 x 60 >9< | SX | PZ | |

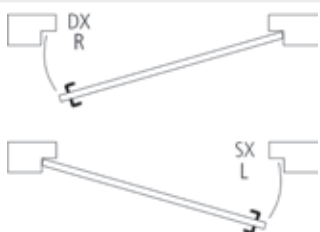

FERRAMENTA/CHIUSURE/VITERIA

2

Serratura da Infilare 40.9714

Serratura da infilare con scontro piano e scivolo antivibrante. Corpo in Ottone Cromato, componenti inossidabili. Adatta per porte sottili. Maniglie da ordinare a parte.

| Cod. | mm | Mano | UM | € |
|---------|-------------|------|----|---|
| 0343345 | 68 x 60 >9< | DX | PZ | |
| 0343346 | 68 x 60 >9< | SX | PZ | |

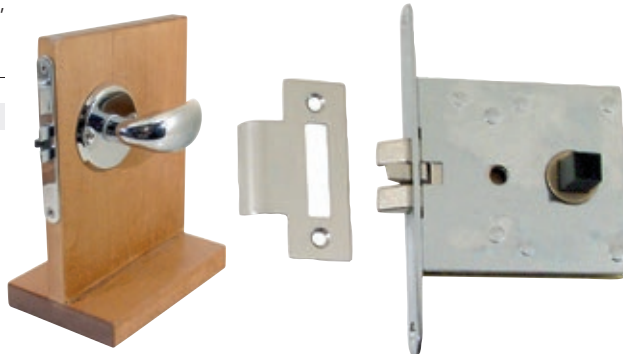
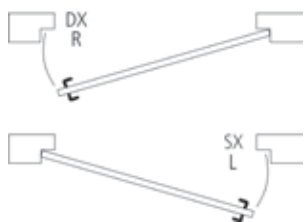
**Serratura da Infilare 4.023**

Serratura da infilare con scontro piano. Corpo in Ottone Cromato, componenti inossidabili. Maniglie da ordinare a parte.

| Cod. | mm | Mostrina mm | Mano | UM | € |
|---------|----------------|-------------|------|----|---|
| 0343343 | 44 x 42,5 >12< | 80 x 15 | DX | PZ | |
| 0343344 | 44 x 42,5 >12< | 80 x 15 | SX | PZ | |

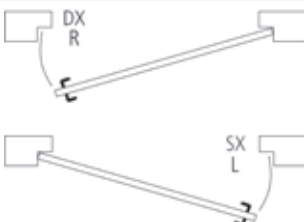
**Maniglia Serratura a Rotazione**

Maniglia serratura a rotazione in Ottone Cromato per chiusure di frigoriferi, porte ed ante. Scontro standard oppure angolato per spessori porta fino a 30 mm.

| Cod. | mm | Scontro | UM | € |
|---------|----------------|----------|----|---|
| 0343820 | 157 x 30 x H35 | Standard | PZ | |
| 0343822 | 157 x 30 x H35 | Angolato | PZ | |

**- SERRATURE PER PORTE SCORREVOLI -****Set Serratura da Infilare 4.070**

Serratura da infilare per porte scorrevoli completa di maniglie, chiavi, scontro piano e placche in Acciaio Inox. Componenti inossidabili. Mano universale DX/SX.

| Cod. | Dim mm | Mostrina mm | Quadro maniglia mm | UM | € |
|---------|---------------|-------------|--------------------|----|---|
| 0343383 | 140 x 70 >12< | 140 x 15 | 8 x 8 | PZ | |

**Set Serratura da Infilare 3.448**

Serratura da infilare per porte scorrevoli completa di maniglie a filo, chiavi, scontro piano e placche in Acciaio Inox. Componenti inossidabili. Spessore porta minimo 20 mm. Mano universale DX/SX.

| Cod. | Dim mm | Mostrina mm | Spessore porta mm | UM | € |
|---------|----------|-------------|-------------------|----|---|
| 0343386 | 158 x 87 | 112 x 15 | Minimo >20< | PZ | |

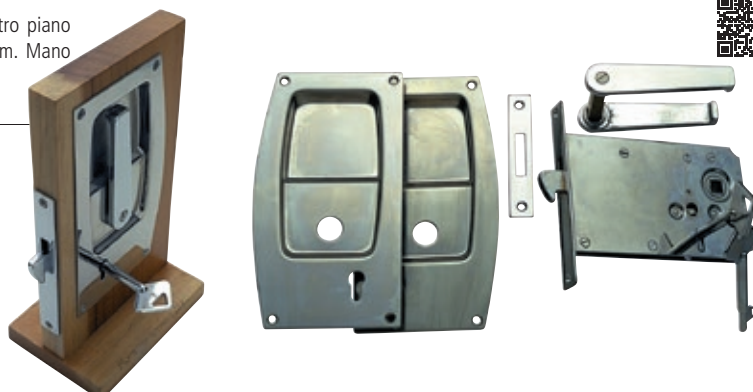

Serratura a Filo Mobella Flush Entry

Serratura a filo in Alluminio Anodizzato per porte scorrevoli, anche per quelle a scomparsa (10-15 cm di accostamento in più rispetto alle altre serrature). Completa di chiavi e sblocco di sicurezza interno per non rimanere bloccati in cabina. Spessore porta 12.5 mm o 10 mm con riduttore opzionale. Mano universale DX/SX.

| Cod. | Taglio mm | Spessore porta | Finitura | Accessori | UM | € |
|----------------|-----------|----------------|----------|-----------------------|----|---|
| 0344510 | 63 x 114 | >12,5< mm | Naturale | | PZ | |
| 0344511 | 63 x 114 | >12,5< mm | Laccata | | PZ | |
| 0344512 | | | | Riduttore 12,5 > 10mm | PZ | |



southco

**Serratura a Filo Mobella Flush Oval**

Serratura a filo in Acciaio Inox per porte scorrevoli, anche per quelle a scomparsa (10-15 cm di accostamento in più rispetto alle altre serrature). Completa di chiavi e sblocco di sicurezza interno per non rimanere bloccati in cabina. Spessore porta 12.5 mm o 10 mm con riduttore opzionale. Mano universale DX/SX.

| Cod. | Taglio mm | Spessore porta | Accessori | UM | € |
|----------------|-----------|----------------|-----------------------|----|---|
| 0344516 | 63 x 114 | >12,5< mm | | PZ | |
| 0344512 | | | Riduttore 12,5 > 10mm | PZ | |



southco

**Serratura da Infilare Omni Spring-Bolt con Blocco Interno**

Serratura da infilare costruita con materiali resistenti alla corrosione. Fornita con sistema di blocco interno di privacy. Facile da installare, basta tagliare a misura la sagoma sul pannello porta. Completa di maniglie incassate e placche in Acciaio Inox. Mano universale DX/SX.

| Cod. | mm | Spessore porta mm | Scontro | UM | € |
|----------------|------------|-------------------|----------|----|---|
| 0345133 | 116 x 81,5 | >12,7< | | PZ | |
| 0345134 | 116 x 81,5 | >16< | | PZ | |
| 0344562 | | | A = 3 mm | PZ | |
| 0344563 | | | A = 5 mm | PZ | |
| 0344564 | | | A = 7 mm | PZ | |

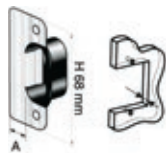

southco

**Serratura a Incasso Mobella Talon**

Serratura a incasso per porte scorrevoli di Alluminio, Vetroresina o Legno. Grande resistenza al salino e alla corrosione. Con meccanismo Positive-Grip che tiene le porte chiuse anche in condizioni estreme. Mano universale DX/SX.

| Cod. | Spessore porta mm | UM | € |
|----------------|-------------------|----|---|
| 0344812 | 23<>27 | PZ | |



southco

**Serratura Mobella Secure con Chiavi**

Serratura Mobella Secure per porte e gavani a scorrimento orizzontale. Corpo in Composito rinforzato e Acciaio Inox.

| Cod. | Dimensioni mm | Spessore porta mm | Colore | UM | € |
|----------------|---------------|-------------------|--------|----|---|
| 0344520 | 55 x 87 | >12< | NERO | PZ | |
| 0344521 | 55 x 87 | >12< | BIANCO | PZ | |

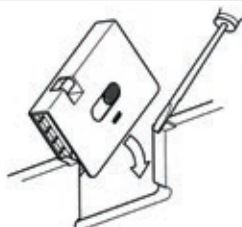

southco

Maniglie con Pomello Ovale

Coppia maniglie con pomello ovale in Ottone Cromato.

| Cod. | L mm | H mm | Quadro mm | UM | € |
|---------|------|------|-----------|----|---|
| 0343400 | 51 | 26 | 8 | PZ | |

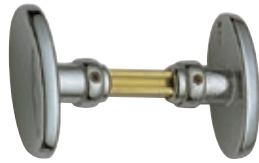
**Maniglie con Pomello Ovale e Anello**

Coppia maniglie con pomello ovale e anello in Ottone Cromato.

| Cod. | L mm | H mm | Quadro mm | UM | € |
|---------|------|------|-----------|----|---|
| 0343401 | 51 | 26 | 8 | PZ | |

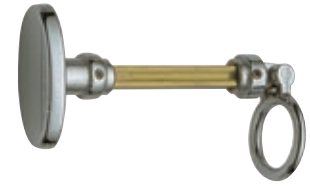
**Maniglie Standard**

Coppia maniglie in Ottone Cromato con curvatura anti-aggiaccio.

| Cod. | L mm | H mm | Quadro mm | UM | € |
|---------|------|------|-----------|----|---|
| 0343402 | 80 | 36 | 8 | PZ | |

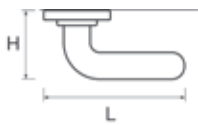
**Maniglie Kata**

Coppia maniglie ergonomiche in Ottone Cromato.

| Cod. | L mm | H mm | Quadro mm | UM | € |
|---------|------|------|-----------|----|---|
| 0343418 | 85 | 20 | 8 | PZ | |

**Maniglie Style**

Coppia maniglie design in Ottone Cromato.

| Cod. | L mm | H mm | Quadro mm | UM | € |
|---------|------|------|-----------|----|---|
| 0343816 | 124 | 46 | 8 | PZ | |

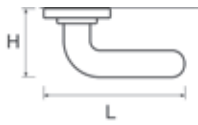
**Maniglie Style 2**

Coppia maniglie design in Ottone Cromato con inserto.

| Cod. | L mm | H mm | Quadro mm | UM | € |
|---------|------|------|-----------|----|---|
| 0343817 | 124 | 46 | 8 | PZ | |

**Maniglie No Catch 2**

Coppia maniglie in Ottone Cromato con estremità sagomate anti-aggiaccio.

| Cod. | L mm | H mm | Quadro mm | UM | € |
|---------|------|------|-----------|----|---|
| 0343818 | 123 | 55 | 8 | PZ | |

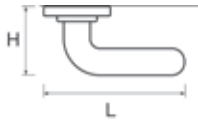
**Maniglie No Catch 4**

Coppia maniglie in Ottone Cromato con montaggio a filo porta per evitare ogni aggiaccio.

| Cod. | L mm | H mm | Quadro mm | UM | € |
|---------|------|------|-----------|----|---|
| 0343819 | 133 | 42 | 8 | PZ | |

**Rosette per Finitura Maniglie**

Rosette per finitura maniglie in Ottone Cromato.

| Cod. | Ref | UM | € |
|---------|-------|----|---|
| 0343410 | Tonda | PZ | |
| 0343412 | Ovale | PZ | |

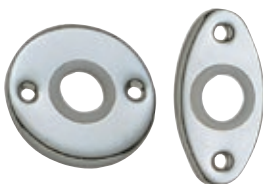
**Rosetta Extra per Finitura Maniglia**

Rosetta extra per finitura maniglia in Ottone Cromato.

| Cod. | ø mm | UM | € |
|---------|------|----|---|
| 0343415 | 60 | PZ | |



Lucchetti Hardinox Arco Standard

Lucchetti con arco standard in Acciaio Inox lucidato a specchio. Robusti, resistenti e sicuri, sono inattaccabili da salsedine e agenti atmosferici.

| Cod. | A mm | B mm | E mm | D mm | C mm | UM | € |
|----------------|------|------|------|------|------|----|---|
| 0344430 | 30 | 27.3 | 15.8 | 4.8 | 17.0 | PZ | |
| 0344440 | 40 | 33.0 | 22.6 | 6.4 | 23.8 | PZ | |
| 0344450 | 50 | 40.3 | 29.5 | 7.9 | 27.9 | PZ | |

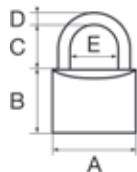

MTM

Lucchetti Hardinox Arco Lungo

Lucchetti con arco lungo in Acciaio Inox lucidato a specchio. Robusti, resistenti e sicuri, sono inattaccabili da salsedine e agenti atmosferici.

| Cod. | A mm | B mm | E mm | D mm | C mm | UM | € |
|----------------|------|------|------|------|------|----|---|
| 0344433 | 30 | 27.3 | 15.8 | 4.8 | 32 | PZ | |
| 0344444 | 40 | 33.0 | 22.6 | 6.4 | 38 | PZ | |
| 0344455 | 50 | 40.3 | 29.5 | 7.9 | 49 | PZ | |

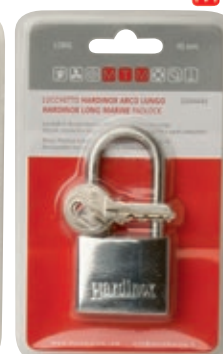
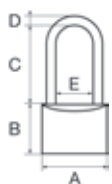

MTM

Set Lucchetti 4+1 Hardinox Master Key

Set di 5 lucchetti Hardinox da 30 mm (4 lucchetti standard + 1 lucchetto long). Chiave universale per tutti i lucchetti, fornita in coppia per ogni lucchetto.

| Cod. | A mm | B mm | E mm | D mm | C mm | C1 mm | UM | € |
|----------------|------|------|------|------|------|-------|----|---|
| 0344463 | 30.0 | 27.3 | 15.8 | 4.8 | 17.0 | 32.0 | CF | |

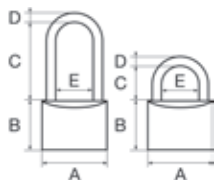

MTM

Barre Antifurto per Motori Fuoribordo

Antifurto per motori fuoribordo con serraggio a levette su specchio di poppa.

La barra 0344400 va completata con il lucchetto 0344444

La barra 0344401 va completata con il lucchetto 0344455

| Cod. | Dim mm | Per motore | UM | € |
|----------------|----------|-------------|----|---|
| 0344400 | 35 x 240 | Fino 25 HP | PZ | |
| 0344401 | 40 x 280 | Oltre 25 HP | PZ | |

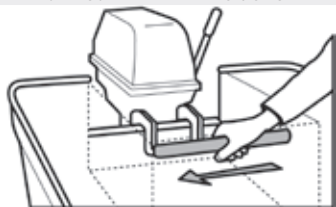
**Barra Antifurto Universale per Motori Fuoribordo**

Antifurto in Acciaio Inox con chiusura a chiave per motori fuoribordo.

| Cod. | Dim mm | UM | € |
|----------------|---------------|----|---|
| 0344404 | 40 x 40 x 300 | PZ | |



Cassaforte VSAFE 200

Cassaforte con tastiera a password utente e luce interna a LED.



VITRIFRIGO

W = Larghezza
L = Lunghezza
H = Altezza

| Cod. | Dim mm | Peso Kg | UM | € |
|----------------|--------------------|---------|----|---|
| 0344000 | W310 x L200 x H200 | 4 | PZ | |

**Cassaforte VSAFE 2535**

Cassaforte con tastiera a password utente, display LED e luce interna a LED.



VITRIFRIGO

W = Larghezza
L = Lunghezza
H = Altezza

| Cod. | Dim mm | Peso Kg | UM | € |
|----------------|--------------------|---------|----|---|
| 0344001 | W350 x L270 x H250 | 11 | PZ | |

**Cassaforte VSAFE 2042**

Cassaforte con tastiera a password utente, display LED e luce interna a LED.



VITRIFRIGO

W = Larghezza
L = Lunghezza
H = Altezza

| Cod. | Dim mm | Peso Kg | UM | € |
|----------------|--------------------|---------|----|---|
| 0344002 | W420 x L370 x H200 | 13 | PZ | |

**Cassaforte VSAFE 2050**

Cassaforte con tastiera a password utente, display LED e luce interna a LED.



VITRIFRIGO

W = Larghezza
L = Lunghezza
H = Altezza

| Cod. | Dim mm | Peso Kg | UM | € |
|----------------|--------------------|---------|----|---|
| 0344003 | W508 x L380 x H200 | 15 | PZ | |

**Casseforti VSAFE Display Top**

Cassaforte da cassetto con apertura dall'alto con tastiera a password utente, display LED e luce interna a LED.



VITRIFRIGO

W = Larghezza
L = Lunghezza
H = Altezza

| Cod. | Dim mm | Peso Kg | UM | € |
|----------------|--------------------|---------|----|---|
| 0344004 | W350 x L400 x H130 | 12 | PZ | |
| 0344005 | W390 x L380 x H180 | 13 | PZ | |



Cerniere a Libro Leggere

Cerniere a libro leggere in Acciaio Inox.

| Cod. | D mm | W mm | H mm | UM | € |
|---------|------|------|------|----|---|
| 0401025 | 0.8 | 25 | 30 | PZ | |
| 0401035 | 0.8 | 35 | 40 | PZ | |
| 0401040 | 0.8 | 40 | 50 | PZ | |

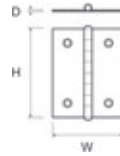

Cerniere a Libro Classiche

Cerniere a libro classiche in Acciaio Inox.

| Cod. | D mm | W mm | H mm | UM | € |
|---------|------|------|------|----|---|
| 0401340 | 1.5 | 40 | 40 | PZ | |
| 0401360 | 1.5 | 40 | 60 | PZ | |
| 0401370 | 1.5 | 50 | 75 | PZ | |

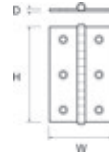

Cerniere a Libro Medie

Cerniere a libro medie in Acciaio Inox.

| Cod. | D mm | W mm | H mm | UM | € |
|---------|------|------|------|----|---|
| 0401380 | 1.5 | 60 | 80 | PZ | |
| 0401382 | 1.5 | 80 | 80 | PZ | |

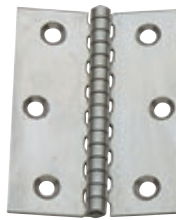
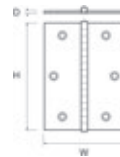

Cerniera a Libro Grande

Cerniera a libro grande in Acciaio Inox.

| Cod. | D mm | W mm | H mm | UM | € |
|---------|------|------|------|----|---|
| 0401385 | 2 | 100 | 100 | PZ | |

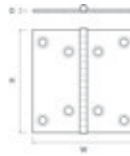

Cerniera a Biscotto

Cerniera a biscotto in Acciaio Inox.

| Cod. | mm | UM | € |
|---------|-----------|----|---|
| 0400075 | H40 x L70 | PZ | |

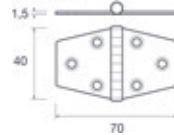

Cerniera Eccentrica

Cerniera eccentrica in Acciaio Inox.

| Cod. | mm | UM | € |
|---------|-----------|----|---|
| 0402057 | H40 x L55 | PZ | |

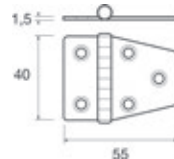

Cerniera Offset Short

Cerniera eccentrica a sbalzo corta in Acciaio Inox.

| Cod. | mm | UM | € |
|---------|-----------|----|---|
| 0403550 | H40 x L55 | PZ | |

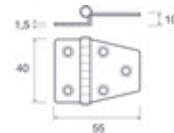

Cerniera Revolve con Blocco a 180°

Cerniera con blocco di apertura a 180° in Acciaio Inox per piani tavolo e gavoni.

| Cod. | mm | UM | € |
|---------|-----------|----|---|
| 0402208 | H30 x L86 | PZ | |

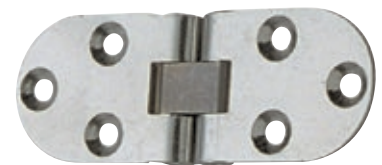
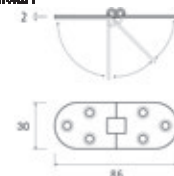

FERRAMENTA/CHIUSURE/VITERIA

2

Cerniera Quadra S

Cerniera quadrata piccola in Acciaio Inox Extracrome.
Standard = Perno Superiore
Centerpin = Perno Centrale

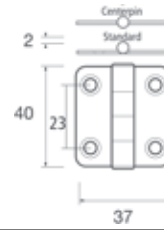

| Cod. | Ref | mm | UM | € |
|---------|-----------|-----------|----|---|
| 0450036 | Standard | H40 x L37 | PZ | |
| 0450136 | Centerpin | H40 x L37 | PZ | |

**Cerniera Biscotto SQ/S**

Cerniera a biscotto piccola in Acciaio Inox Extracrome con angoli squadrati.
Standard = Perno Superiore
Centerpin = Perno Centrale
Reverse = Perno Inferiore

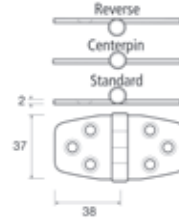

| Cod. | Ref | mm | UM | € |
|---------|-----------|--------------|----|---|
| 0450037 | Standard | H43 x L38+38 | PZ | |
| 0450137 | Centerpin | H43 x L38+38 | PZ | |
| 0450237 | Reverse | H43 x L38+38 | PZ | |

**Cerniera Biscotto SR/S**

Cerniera a biscotto senza spigoli in Acciaio Inox Extracrome.
Standard = Perno Superiore
Centerpin = Perno Centrale
Reverse = Perno Inferiore

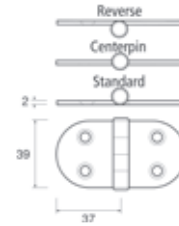

| Cod. | Ref | mm | UM | € |
|---------|-----------|--------------|----|---|
| 0450039 | Standard | H39 x L37+37 | PZ | |
| 0450139 | Centerpin | H39 x L37+37 | PZ | |
| 0450239 | Reverse | H39 x L37+37 | PZ | |

**Cerniera Biscotto SQ/M**

Cerniera a biscotto media in Acciaio Inox Extracrome con angoli squadrati.

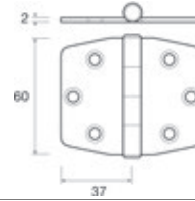

| Cod. | mm | UM | € |
|---------|--------------|----|---|
| 0450060 | H60 x L37+37 | PZ | |

**Cerniera Biscotto SQ/L**

Cerniera a biscotto grande in Acciaio Inox Extracrome con angoli squadrati.

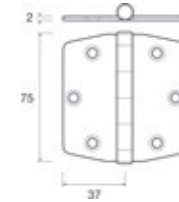

| Cod. | mm | UM | € |
|---------|--------------|----|---|
| 0450075 | H75 x L37+37 | PZ | |

**Cerniere Oval Classic**

Cerniere ovali in Acciaio Inox Extracrome.



| Cod. | mm | UM | € |
|---------|-----------|----|---|
| 0456602 | H35 x L51 | PZ | |
| 0456604 | H48 x L67 | PZ | |
| 0456606 | H56 x L78 | PZ | |

**Cerniere Oval Extra**

Cerniere ovali in Acciaio Inox Extracrome.



| Cod. | Ref | mm | UM | € |
|---------|----------|-----------|----|---|
| 0456607 | Big | H56 x L90 | PZ | |
| 0456610 | Excenter | H56 x L84 | PZ | |
| 0456612 | Long | H56 x L78 | PZ | |



Cerniera Wing S

Cerniera a doppia ala piccola in Acciaio Inox Extracrome.

| Cod. | mm | UM | € |
|---------|--------------|----|---|
| 0452210 | H27 x L50+50 | PZ | |

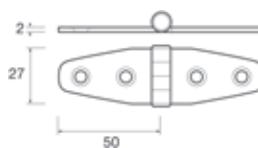
**Cerniera Wing M**

Cerniera a doppia ala media in Acciaio Inox Extracrome.

Standard = Perno Superiore

Centerpin = Perno Centrale

| Cod. | Ref | mm | UM | € |
|---------|-----------|--------------|----|---|
| 0452213 | Standard | H39 x L70+70 | PZ | |
| 0452313 | Centerpin | H39 x L70+70 | PZ | |

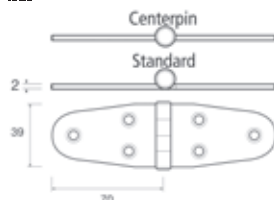
**Cerniera Wing L**

Cerniera a doppia ala grande in Acciaio Inox Extracrome.

| Cod. | mm | UM | € |
|---------|--------------|----|---|
| 0452218 | H40 x L90+90 | PZ | |

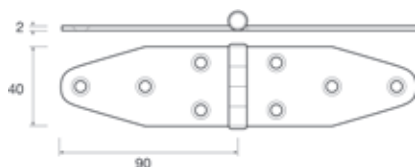
**Cerniera Eccentrica S**

Cerniera eccentrica piccola in Acciaio Inox Extracrome.

Standard = Perno Superiore

Reverse = Perno Inferiore

| Cod. | Ref | mm | UM | € |
|---------|----------|--------------|----|---|
| 0452508 | Standard | H40 x L36+19 | PZ | |
| 0452708 | Reverse | H40 x L37+22 | PZ | |

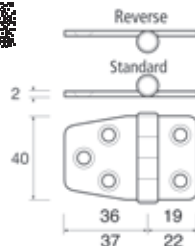
**Cerniera Eccentrica M**

Cerniera eccentrica media in Acciaio Inox Extracrome.

| Cod. | mm | UM | € |
|---------|--------------|----|---|
| 0452512 | H39 x L70+30 | PZ | |

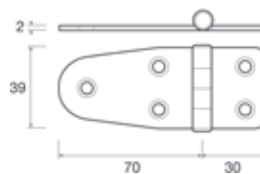
**Cerniera Eccentrica R**

Cerniera eccentrica media senza spigoli in Acciaio Inox Extracrome.

Standard = Perno Superiore

Centerpin = Perno Centrale

| Cod. | Ref | mm | UM | € |
|---------|-----------|--------------|----|---|
| 0452516 | Standard | H39 x L70+37 | PZ | |
| 0452616 | Centerpin | H39 x L70+37 | PZ | |

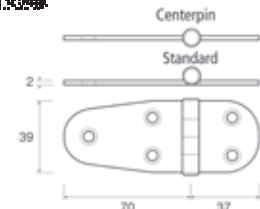
**Cerniera Eccentrica L**

Cerniera eccentrica grande in Acciaio Inox Extracrome.

| Cod. | mm | UM | € |
|---------|--------------|----|---|
| 0452519 | H40 x L39+90 | PZ | |

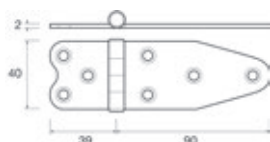

Cerniera Offset Mini

Piccola cerniera a sbalzo in Acciaio Inox.

| Cod. | mm | UM | € |
|---------|-------------|----|---|
| 0403535 | H37,5 x L38 | PZ | |

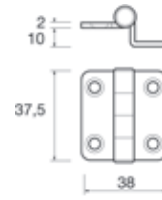
**Cerniera Offset Long**

Cerniera eccentrica a sbalzo lunga in Acciaio Inox.

| Cod. | mm | H mm | UM | € |
|---------|-----------|------|----|---|
| 0403560 | H38 x L65 | 10 | PZ | |
| 0403561 | H38 x L65 | 24 | PZ | |

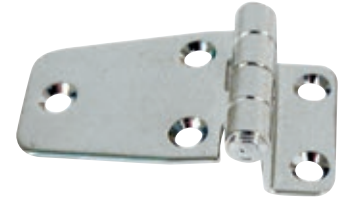
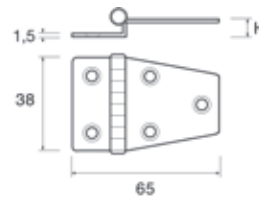
**Cerniera Offset Bassa**

Cerniera a sbalzo basso in Acciaio Inox per boccaporti e portelli.

| Cod. | mm | UM | € |
|---------|--------------|----|---|
| 0453524 | H40 x L95+42 | PZ | |

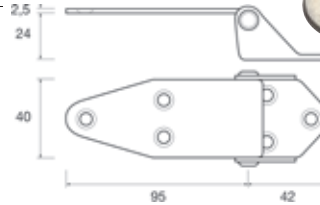
**Cerniera Offset Alta**

Cerniera a sbalzo alto in Acciaio Inox per boccaporti e portelli.

| Cod. | mm | UM | € |
|---------|--------------|----|---|
| 0453534 | H40 x L95+42 | PZ | |

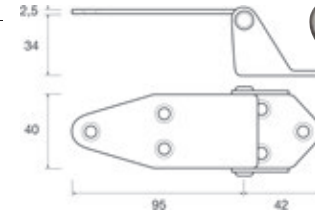
**Cerniera Offset Nervata Bassa**

Cerniera a sbalzo basso in Acciaio Inox stampato per boccaporti e portelli.

| Cod. | mm | UM | € |
|---------|--------------|----|---|
| 0453620 | H40 x L50+81 | PZ | |

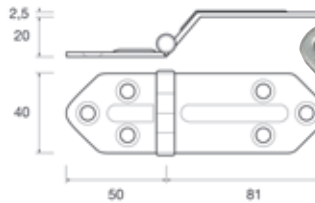
**Cerniera Offset Nervata Alta**

Cerniera a sbalzo alto in Acciaio Inox stampato per boccaporti e portelli.

| Cod. | mm | UM | € |
|---------|--------------|----|---|
| 0453635 | H40 x L50+81 | PZ | |

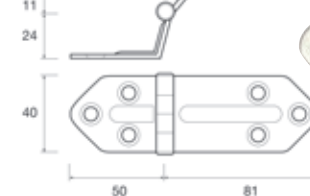
**Cerniere a Metro**

Cerniere in Acciaio Inox in verghe da 2 metri. Fori da 3 mm con interasse 60 mm.

| Cod. | D mm | W mm | L m | UM | € |
|---------|------|------|-----|----|---|
| 0420025 | 0.8 | 25 | 2 | PZ | |
| 0420032 | 0.8 | 32 | 2 | PZ | |
| 0420040 | 0.8 | 40 | 2 | PZ | |



Cerniera Eccentrica Sfilabile a Sbalzo

Cerniere eccentriche sfilabili a sbalzo in Acciaio Inox Extracrome.

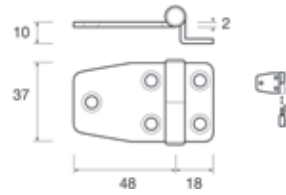

| Cod. | Verso | mm | UM | € |
|---------|-------|--------------|----|---|
| 0455505 | DX | H37 x L48+18 | PZ | |
| 0455504 | SX | H37 x L48+18 | PZ | |

**Cerniera Sfilabile a Sbalzo Quadra S**

Cerniere sfilabili su due piani in Acciaio Inox Extracrome. Permettono l'apertura totale a 180° di porte e portelli.

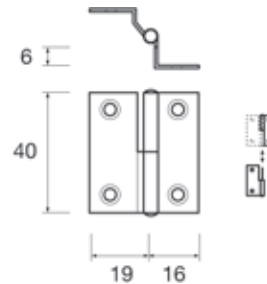

| Cod. | Verso | mm | UM | € |
|---------|-------|--------------|----|---|
| 0456540 | DX | H40 x L19+16 | PZ | |
| 0456539 | SX | H40 x L19+16 | PZ | |

**Cerniera Sfilabile a Sbalzo Quadra L**

Cerniere sfilabili su due piani in Acciaio Inox Extracrome. Permettono l'apertura totale a 180° di porte e portelli.

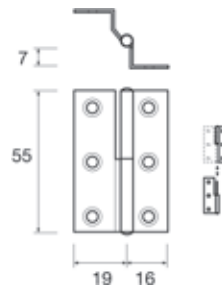

| Cod. | Verso | mm | UM | € |
|---------|-------|--------------|----|---|
| 0456555 | DX | H55 x L19+16 | PZ | |
| 0456554 | SX | H55 x L19+16 | PZ | |

**Cerniera Sfilabile S**

Cerniere sfilabili compatte in Acciaio Inox Extracrome.

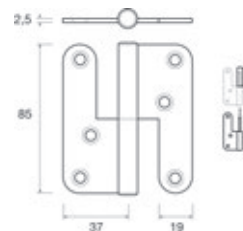

| Cod. | Verso | mm | UM | € |
|---------|-------|--------------|----|---|
| 0455508 | DX | H85 x L37+19 | PZ | |
| 0455507 | SX | H85 x L37+19 | PZ | |

**Cerniera Sfilabile L**

Cerniere sfilabili grandi in Acciaio Inox Extracrome.



| Cod. | Verso | mm | UM | € |
|---------|-------|---------------|----|---|
| 0455512 | DX | H110 x L49+25 | PZ | |
| 0455511 | SX | H110 x L49+25 | PZ | |

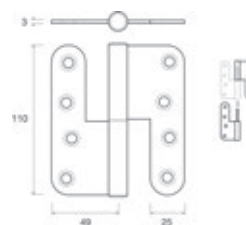

Cerniera Robusta Quadra M

Cerniera molto robusta quadrata media in Acciaio Inox Extracrome. Spessore 3 mm.

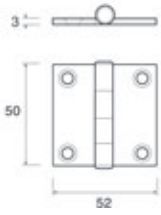

| Cod. | mm | UM | € |
|---------|-----------|----|---|
| 0452902 | H50 x L52 | PZ | |

**Cerniera Robusta Biscotto M**

Cerniera molto robusta a biscotto media in Acciaio Inox Extracrome. Spessore 3 mm.

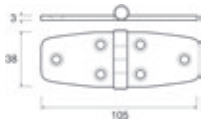

| Cod. | mm | UM | € |
|---------|------------|----|---|
| 0452910 | H38 x L105 | PZ | |

**Cerniera Robusta Wing M**

Cerniera media a doppia ala molto robusta in Acciaio Inox Extracrome. Spessore 3 mm.

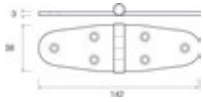

| Cod. | mm | UM | € |
|---------|------------|----|---|
| 0452914 | H38 x L142 | PZ | |

**Cerniera Coperta Quadra**

Cerniera quadrata con copertura in Acciaio Inox Extracrome.

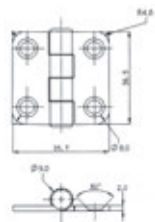

| Cod. | mm | UM | € |
|---------|---------------|----|---|
| 0452804 | H36,5 x L35,7 | PZ | |

**Cerniera Coperta Biscotto S**

Cerniera a Biscotto con copertura in Acciaio Inox Extracrome.

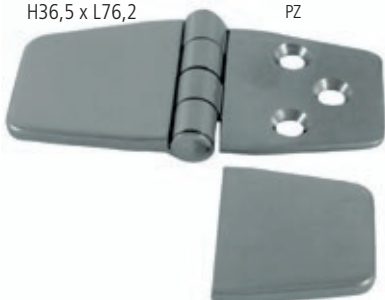
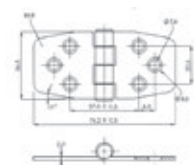

| Cod. | mm | UM | € |
|---------|---------------|----|---|
| 0452807 | H36,5 x L76,2 | PZ | |

**Cerniera Robusta Biscotto S**

Cerniera a biscotto molto robusta piccola in Acciaio Inox Extracrome. Spessore 3 mm.

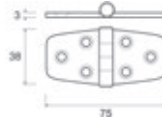

| Cod. | mm | UM | € |
|---------|-----------|----|---|
| 0452904 | H38 x L75 | PZ | |

**Cerniera Robusta Eccentrica M**

Cerniera eccentrica media molto robusta in Acciaio Inox Extracrome. Spessore 3 mm.

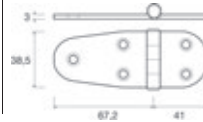

| Cod. | mm | UM | € |
|---------|------------------|----|---|
| 0452911 | H38,5 x L67,2+41 | PZ | |

**Cerniera Robusta Offset M**

Cerniera eccentrica media a sbalzo molto robusta in Acciaio Inox Extracrome. Spessore 3 mm.

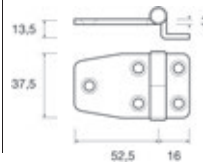

| Cod. | mm | UM | € |
|---------|------------------|----|---|
| 0452923 | H37,5 x L52,5+16 | PZ | |

**Cerniera Coperta Biscotto L**

Cerniere a biscotto grande con copertura in Acciaio Inox Extracrome.

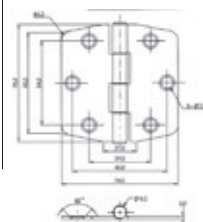

| Cod. | mm | UM | € |
|---------|-----------|----|---|
| 0452817 | H75 x L74 | PZ | |

**Cerniera Coperta Eccentrica S**

Cerniera eccentrica con copertura in Acciaio Inox Extracrome.



| Cod. | mm | UM | € |
|---------|---------------|----|---|
| 0452808 | H36,5 x L56,7 | PZ | |

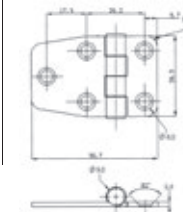

Cerniera Frenata Quadrata 38x38

Cerniera Roca in Acciaio Inox frizionata con sistema a cuscinetti in Bronzo GEM. Progettata per l'ambiente marino, permette di aprire e chiudere porte, portelli e chiusure senza urti e danni da fine corsa o da colpi di vento. Il momento torcente della frizione può essere regolato con vite a brugola sul perno, migliorando l'efficacia della cerniera.

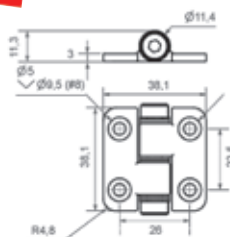

| Cod. | UM | € |
|---------|----|---|
| 0451000 | PZ | |

New**Cerniera Frenata a Libro 50x59**

Cerniera Roca in Acciaio Inox frizionata con sistema a cuscinetti in Bronzo GEM. Progettata per l'ambiente marino, permette di aprire e chiudere porte, portelli e chiusure senza urti e danni da fine corsa o da colpi di vento. Il momento torcente della frizione può essere regolato con vite a brugola sul perno, migliorando l'efficacia della cerniera.

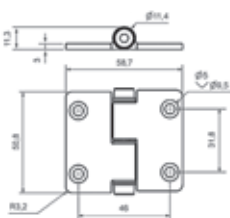

| Cod. | UM | € |
|---------|----|---|
| 0451002 | PZ | |

New**Cerniera Frenata a Libro 76x50**

Cerniera Roca in Acciaio Inox frizionata con sistema a cuscinetti in Bronzo GEM. Progettata per l'ambiente marino, permette di aprire e chiudere porte, portelli e chiusure senza urti e danni da fine corsa o da colpi di vento. Il momento torcente della frizione può essere regolato con vite a brugola sul perno, migliorando l'efficacia della cerniera.

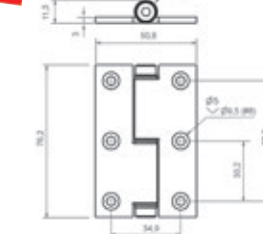

| Cod. | UM | € |
|---------|----|---|
| 0451004 | PZ | |

New**Cerniera Frenata Biscotto 38x76**

Cerniera Roca in Acciaio Inox frizionata con sistema a cuscinetti in Bronzo GEM. Progettata per l'ambiente marino, permette di aprire e chiudere porte, portelli e chiusure senza urti e danni da fine corsa o da colpi di vento. Il momento torcente della frizione può essere regolato con vite a brugola sul perno, migliorando l'efficacia della cerniera.

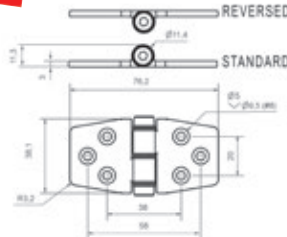

| Cod. | Perno | UM | € |
|---------|----------|----|---|
| 0451006 | Standard | PZ | |
| 0451007 | Reverse | PZ | |

New**Cerniera Frenata Biscotto Smooth 38x76**

Cerniera Roca in Acciaio Inox frizionata con sistema a cuscinetti in Bronzo GEM. Progettata per l'ambiente marino, permette di aprire e chiudere porte, portelli e chiusure senza urti e danni da fine corsa o da colpi di vento. Il momento torcente della frizione può essere regolato con vite a brugola sul perno, migliorando l'efficacia della cerniera.

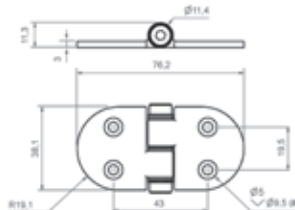

| Cod. | UM | € |
|---------|----|---|
| 0451008 | PZ | |

New

Cerniera Frenata Quadrata MTech 40x41

Cerniera frizionata in Acciaio Inox A4 AISI316 con momento torcente da 2,2 Nm e componenti antivibranti. Permette di aprire e chiudere porte, portelli e chiusure senza urti e danni da fine corsa o da colpi di vento.

| Cod. | L mm | B mm | A mm | A1 mm | S mm | BD mm | UM | € |
|---------|------|------|------|-------|------|-------|----|---|
| 0451104 | 40 | 41 | 26 | 23 | 2 | 5,5 | PZ | |

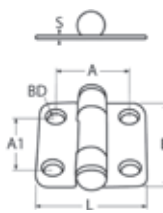
**New****Cerniera Frenata Biscotto MTech 38x38**

Cerniera frizionata in Acciaio Inox A4 AISI316 con momento torcente da 1,5 Nm e componenti antivibranti. Permette di aprire e chiudere porte, portelli e chiusure senza urti e danni da fine corsa o da colpi di vento.

| Cod. | L mm | B mm | A mm | A1 mm | S mm | BD mm | UM | € |
|---------|------|------|------|-------|------|-------|----|---|
| 0451103 | 38 | 38 | 27 | 25 | 2 | 5,5 | PZ | |

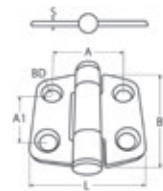
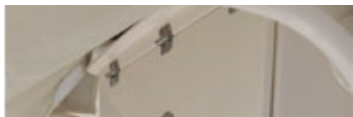
**New****Cerniera Frenata Biscotto MTech 76x42**

Cerniera frizionata in Acciaio Inox A4 AISI316 con momento torcente da 1,6 Nm e componenti antivibranti. Permette di aprire e chiudere porte, portelli e chiusure senza urti e danni da fine corsa o da colpi di vento.

| Cod. | L mm | B mm | A mm | A1 mm | A2 mm | S mm | BD mm | UM | € |
|---------|------|------|------|-------|-------|------|-------|----|---|
| 0451106 | 76 | 42 | 35 | 56 | 20 | 2 | 6 | PZ | |

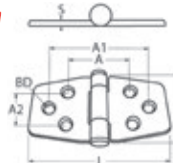
**New****Cerniera Frenata Eccentrica MTech 57x18**

Cerniera frizionata in Acciaio Inox A4 AISI316 con momento torcente da 1,5 Nm e componenti antivibranti. Permette di aprire e chiudere porte, portelli e chiusure senza urti e danni da fine corsa o da colpi di vento.

| Cod. | L mm | L1 mm | B mm | S mm | BD mm | UM | € |
|---------|------|-------|------|------|-------|----|---|
| 0451105 | 57 | 18 | 42 | 2 | 5,6 | PZ | |

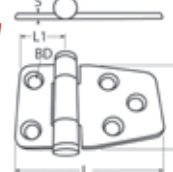
**New****Cerniera Frenata Centopiedi Ala Corta**

Cerniera frizionata in Acciaio Inox A4 AISI316 con momento torcente da 1,9 Nm e componenti antivibranti. Permette di aprire e chiudere porte, portelli e chiusure senza urti e danni da fine corsa o da colpi di vento.

| Cod. | L mm | L1 mm | B mm | A mm | S mm | BD mm | UM | € |
|---------|------|-------|------|------|------|-------|----|---|
| 0451115 | 28,5 | 9,6 | 51 | 24 | 2 | 4 | PZ | |
| 0451117 | 28,5 | 9,6 | 75 | 24 | 2 | 4 | PZ | |
| 0451119 | 28,5 | 9,6 | 99 | 24 | 2 | 4 | PZ | |
| 0451121 | 28,5 | 9,6 | 123 | 24 | 2 | 4 | PZ | |

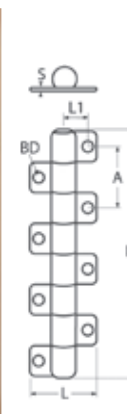
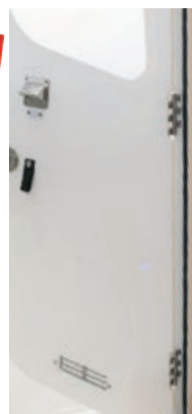
New**Cerniera Frenata Centopiedi Ala Lunga**

Cerniera frizionata in Acciaio Inox A4 AISI316 con momento torcente da 2,0 Nm e componenti antivibranti. Permette di aprire e chiudere porte, portelli e chiusure senza urti e danni da fine corsa o da colpi di vento.

| Cod. | L mm | L1 mm | B mm | A mm | S mm | BD mm | UM | € |
|---------|------|-------|------|------|------|-------|----|---|
| 0451125 | 45 | 17,5 | 54 | 25,4 | 2 | 4,7 | PZ | |
| 0451127 | 45 | 17,5 | 79 | 25,4 | 2 | 4,7 | PZ | |
| 0451130 | 45 | 17,5 | 105 | 25,4 | 2 | 4,7 | PZ | |
| 0451133 | 45 | 17,5 | 130 | 25,4 | 2 | 4,7 | PZ | |

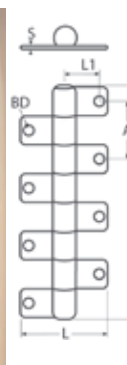
New

Cerniera a Filo Slim S

Cerniera a filo in Acciaio Inox extra lucido. Fissaggio con viti dall'interno.

| Cod. | mm | UM | € |
|---------|---------|----|---|
| 0453018 | 70 x 35 | PZ | |

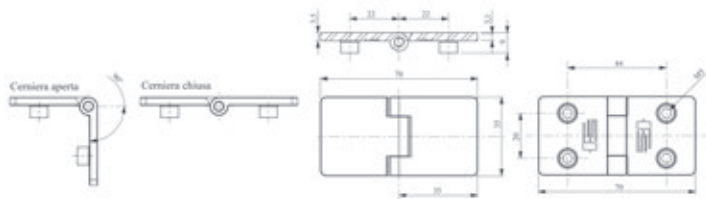

Cerniera a Filo Slim M

Cerniera a filo in Acciaio Inox extra lucido. Fissaggio con viti dall'interno.

| Cod. | mm | UM | € |
|---------|---------|----|---|
| 0453011 | 70 x 65 | PZ | |

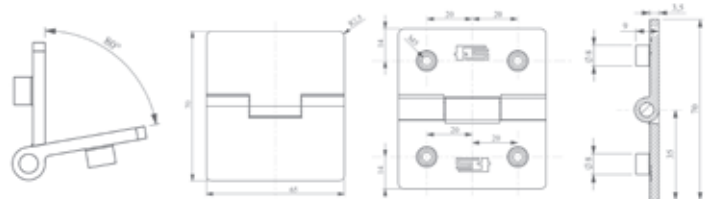

Cerniera a Filo Slim Eccentrica S

Cerniera eccentrica a filo in Acciaio Inox extra lucido. Fissaggio con viti interne ed esterne.

| Cod. | mm | UM | € |
|---------|---------|----|---|
| 0453017 | 55 x 35 | PZ | |

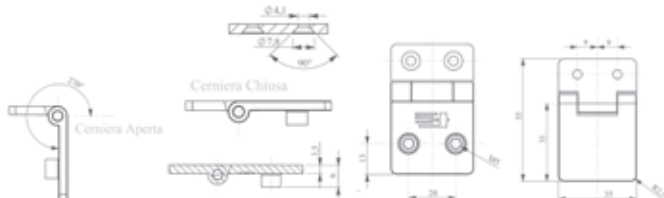

Cerniera a Filo Slim Eccentrica M

Cerniera eccentrica a filo in Acciaio Inox extra lucido. Fissaggio con viti interne ed esterne.

| Cod. | mm | UM | € |
|---------|---------|----|---|
| 0453012 | 65 x 55 | PZ | |

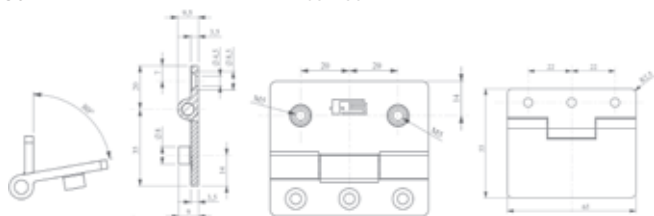

Cerniera a Filo Eccentrica M

Cerniera eccentrica a filo in Acciaio Inox extra lucido. Fissaggio con viti interne ed esterne.

| Cod. | mm | UM | € |
|---------|---------|----|---|
| 0453014 | 70 x 30 | PZ | |

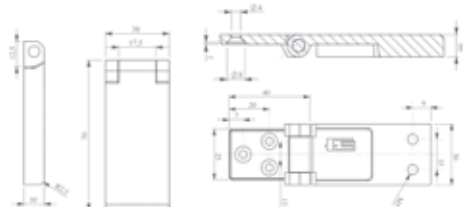

Cerniera a Filo Eccentrica S

Cerniera eccentrica a filo in Acciaio Inox extra lucido. Fissaggio con viti interne ed esterne.

| Cod. | mm | UM | € |
|---------|---------|----|---|
| 0453013 | 45 x 30 | PZ | |

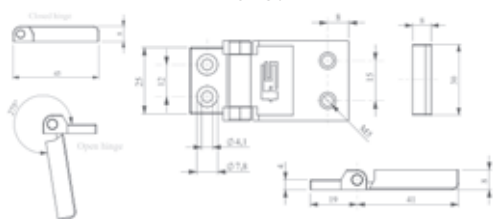

FERRAMENTA/CHIUSURE/VITERIA

2

Cerniere Sfilabili Classiche

Cerniere sfilabili classiche in Ottone Cromato con perno centrale.

| Cod. | mm | Ref | UM | € |
|---------|---------|-----|----|---|
| 0410006 | 60 x 50 | DX | PZ | |
| 0410005 | 60 x 50 | SX | PZ | |

**Cerniere Sfilabili Basse**

Cerniere sfilabili basse in Ottone Cromato.

| Cod. | mm | Ref | UM | € |
|---------|----------|-----|----|---|
| 0410010 | 100 x 30 | DX | PZ | |
| 0410009 | 100 x 30 | SX | PZ | |

**Cerniera a Sbalzo Standard per Boccaporto**

Cerniera a sbalzo bassa in Ottone Cromato per boccaporti.

| Cod. | mm | H mm | UM | € |
|---------|---------|------|----|---|
| 0413509 | 96 x 59 | 10 | PZ | |

**Cerniera a Sbalzo Lunga per Boccaporti**

Cerniera a sbalzo alta e lunga in Ottone Cromato per boccaporti.

| Cod. | mm | H | UM | € |
|---------|----------|----|----|---|
| 0413513 | 135 x 58 | 40 | PZ | |

**Cerniera per Scalette**

Cerniera in Ottone Cromato per scalette pieghevoli.

| Cod. | mm | UM | € |
|---------|----------|----|---|
| 0412514 | 145 x 20 | PZ | |

**Gancio & Piastra per Scalette**

Gancio e piastra in Ottone Cromato per scalette.

| Cod. | Ref | UM | € |
|---------|---------------------|----|---|
| 0422515 | Gancio per scaletta | PZ | |
| 0422516 | Piastra per gancio | PZ | |

**- CERNIERE IN PLASTICA RINFORZATA -****Cerniera a Biscotto 40x63**

Cerniere a biscotto in Plastica rinforzata.

| Cod. | mm | Colore | UM | € |
|---------|---------|--------|----|---|
| 0430006 | 40 x 63 | NERO | PZ | |
| 0430026 | 40 x 63 | BIANCO | PZ | |

**Cerniera a Biscotto 60x95**

Cerniere a biscotto in Plastica rinforzata.

| Cod. | mm | Colore | UM | € |
|---------|---------|--------|----|---|
| 0430009 | 60 x 95 | NERO | PZ | |
| 0430029 | 60 x 95 | BIANCO | PZ | |

**Cerniera Ovale 40x70**

Cerniere ovali in Plastica rinforzata.

| Cod. | mm | Colore | UM | € |
|---------|---------|--------|----|---|
| 0430007 | 40 x 70 | NERO | PZ | |
| 0430027 | 40 x 70 | BIANCO | PZ | |

**Cerniera Wing 40x100**

Cerniere a doppia ala in Plastica rinforzata.

| Cod. | mm | Colore | UM | € |
|---------|----------|--------|----|---|
| 0430410 | 40 x 100 | NERO | PZ | |
| 0430430 | 40 x 100 | BIANCO | PZ | |



Dadi Esagonali UNI 5688 DIN 934

Dadi esagonali UNI 5688 DIN 934 in Acciaio Inox A2.



| Cod. | mm | Pezzi / CF | UM | € |
|--------------|-----|------------|----|---|
| 620093400310 | M3 | 100 | CF | |
| 620093400410 | M4 | 100 | CF | |
| 620093400510 | M5 | 100 | CF | |
| 620093400610 | M6 | 100 | CF | |
| 620093400810 | M8 | 100 | CF | |
| 620093401005 | M10 | 50 | CF | |
| 620093401205 | M12 | 50 | CF | |
| 620093401402 | M14 | 20 | CF | |
| 620093401602 | M16 | 20 | CF | |
| 620093401801 | M18 | 10 | CF | |

Dadi Autobloccanti DIN 985

Dadi autobloccanti DIN 985 in Acciaio Inox A2.



| Cod. | mm | Pezzi / CF | UM | € |
|--------------|-----|------------|----|---|
| 620098500405 | M4 | 50 | CF | |
| 620098500505 | M5 | 50 | CF | |
| 620098500605 | M6 | 50 | CF | |
| 620098500805 | M8 | 50 | CF | |
| 620098501005 | M10 | 50 | CF | |
| 620098501202 | M12 | 20 | CF | |
| 620098501401 | M14 | 10 | CF | |

Dadi Ciechi a Calotta UNI 5721 DIN 1587

Dadi ciechi a calotta UNI 5721 DIN 1587 in Acciaio Inox A2.



| Cod. | mm | Pezzi / CF | UM | € |
|--------------|-----|------------|----|---|
| 620158700405 | M4 | 50 | CF | |
| 620158700505 | M5 | 50 | CF | |
| 620158700605 | M6 | 50 | CF | |
| 620158700802 | M8 | 20 | CF | |
| 620158701002 | M10 | 20 | CF | |
| 620158701202 | M12 | 20 | CF | |
| 620158701401 | M14 | 10 | CF | |

Dadi ad Alette UNI 5448 DIN 315

Dadi ad alette UNI 5448 DIN 315 in Acciaio Inox A2.



| Cod. | mm | Pezzi / CF | UM | € |
|--------------|-----|------------|----|---|
| 620031500505 | M5 | 50 | CF | |
| 620031500605 | M6 | 50 | CF | |
| 620031500802 | M8 | 20 | CF | |
| 620031501002 | M10 | 20 | CF | |
| 620031501201 | M12 | 10 | CF | |

Rondelle Piane UNI 6592 DIN 125

Rondelle piane UNI 6592 DIN 125 in Acciaio Inox A2.



| Cod. | mm | Pezzi / CF | UM | € |
|--------------|------|------------|----|---|
| 625011250310 | D.3 | 100 | CF | |
| 625011250410 | D.4 | 100 | CF | |
| 625011250510 | D.5 | 100 | CF | |
| 625011250610 | D.6 | 100 | CF | |
| 625011250810 | D.8 | 100 | CF | |
| 625011251010 | D.10 | 100 | CF | |
| 625011251205 | D.12 | 50 | CF | |
| 625011251405 | D.14 | 50 | CF | |
| 625011251602 | D.16 | 20 | CF | |
| 625011251802 | D.18 | 20 | CF | |

Rondelle Piane 3 Volte il Foro

Rondelle piane 3 volte il foro in Acciaio Inox A2.



| Cod. | mm | Pezzi / CF | UM | € |
|--------------|-------|------------|----|---|
| 625000039010 | 3x9 | 100 | CF | |
| 625000041210 | 4x12 | 100 | CF | |
| 625000051510 | 5x15 | 100 | CF | |
| 625000061810 | 6x18 | 100 | CF | |
| 625000082410 | 8x24 | 100 | CF | |
| 625000103005 | 10x30 | 50 | CF | |
| 625000123602 | 12x36 | 20 | CF | |
| 625000144202 | 14x42 | 20 | CF | |

Rondelle Grower UNI 1751 DIN 127

Rondelle Grower UNI 1751 DIN 127 in Acciaio Inox A2.



| Cod. | mm | Pezzi / CF | UM | € |
|--------------|------|------------|----|---|
| 625011270310 | D.3 | 100 | CF | |
| 625011270410 | D.4 | 100 | CF | |
| 625011270510 | D.5 | 100 | CF | |
| 625011270610 | D.6 | 100 | CF | |
| 625011270810 | D.8 | 100 | CF | |
| 625011271010 | D.10 | 100 | CF | |
| 625011271205 | D.12 | 50 | CF | |
| 625011271405 | D.14 | 50 | CF | |
| 625011271602 | D.16 | 20 | CF | |
| 625011271802 | D.18 | 20 | CF | |

Barre Filettate da Metri 1 DIN 975

Barre filettate da 1 metro DIN 975 in Acciaio Inox A2.



| Cod. | mm | UM | € |
|------------|-----|----|---|
| 6300997504 | M4 | PZ | |
| 6300997505 | M5 | PZ | |
| 6300997506 | M6 | PZ | |
| 6300997508 | M8 | PZ | |
| 6300997510 | M10 | PZ | |
| 6300997512 | M12 | PZ | |
| 6300997514 | M14 | PZ | |
| 6300997516 | M16 | PZ | |
| 6300997518 | M18 | PZ | |

Copiglie UNI 1336 DIN 94

Copiglie UNI 1336 DIN 94 in Acciaio Inox A4.



| Cod. | mm | Pezzi / CF | UM | € |
|--------------|--------|------------|----|---|
| 650094152010 | 1,5x20 | 100 | CF | |
| 650094152510 | 1,5x25 | 100 | CF | |
| 650094022010 | 2x20 | 100 | CF | |
| 650094022510 | 2x25 | 100 | CF | |
| 650094023010 | 2x30 | 100 | CF | |
| 650094252010 | 2,5x20 | 100 | CF | |
| 650094252510 | 2,5x25 | 100 | CF | |
| 650094253010 | 2,5x30 | 100 | CF | |
| 650094253510 | 2,5x35 | 100 | CF | |
| 650094032010 | 3x20 | 100 | CF | |
| 650094032510 | 3x25 | 100 | CF | |
| 650094033010 | 3x30 | 100 | CF | |
| 650094033510 | 3x35 | 100 | CF | |
| 650094034010 | 3x40 | 100 | CF | |
| 650094035010 | 3x50 | 100 | CF | |
| 650094043010 | 4x30 | 100 | CF | |
| 650094044005 | 4x40 | 50 | PZ | |
| 650094045005 | 4x50 | 50 | PZ | |
| 650094054005 | 5x40 | 50 | CF | |
| 650094055005 | 5x50 | 50 | CF | |
| 650094056005 | 5x60 | 50 | CF | |
| 650094065005 | 6x50 | 50 | CF | |
| 650094066005 | 6x60 | 50 | CF | |

Rivetti a Strappo

Rivetti a strappo in Acciaio Inox A2.



| Cod. | mm | Pezzi / CF | UM | € |
|-------------|----------|------------|----|---|
| 6600000326 | 3,2 x 6 | 100 | CF | |
| 6600000329 | 3,2 x 8 | 100 | CF | |
| 66000003211 | 3,2 x 10 | 100 | CF | |
| 66000003212 | 3,2 x 12 | 100 | CF | |
| 6600000389 | 4 x 8 | 100 | CF | |
| 66000003811 | 4 x 10 | 100 | CF | |
| 66000003812 | 4 x 12 | 100 | CF | |
| 66000003814 | 4 x 14 | 100 | CF | |
| 66000003816 | 4 x 16 | 100 | CF | |
| 6600000489 | 4,8 x 8 | 100 | CF | |
| 66000004811 | 4,8 x 10 | 100 | CF | |
| 66000004812 | 4,8 x 12 | 100 | CF | |
| 66000004814 | 4,8 x 14 | 100 | CF | |
| 66000004816 | 4,8 x 16 | 100 | CF | |
| 66000004818 | 4,8 x 18 | 100 | CF | |

Viti Testa Esagonale UNI 5739 DIN 933

Viti testa esagonale UNI 5739 DIN 933 in Acciaio Inox A4.



| Cod. | mm | Pezzi / CF | UM | € |
|--------------|--------|------------|----|---|
| 709330052010 | 5x20 | 100 | CF | |
| 709330053010 | 5x30 | 100 | CF | |
| 709330054005 | 5x40 | 50 | CF | |
| 709330055005 | 5x50 | 50 | CF | |
| 709330062005 | 6x20 | 50 | CF | |
| 709330063005 | 6x30 | 50 | CF | |
| 709330064005 | 6x40 | 50 | CF | |
| 709330065005 | 6x50 | 50 | CF | |
| 709330066005 | 6x60 | 50 | CF | |
| 709330068002 | 6x80 | 20 | CF | |
| 709330610002 | 6x100 | 20 | CF | |
| 709330083005 | 8x30 | 50 | CF | |
| 709330084005 | 8x40 | 50 | CF | |
| 709330085005 | 8x50 | 50 | CF | |
| 709330086002 | 8x60 | 20 | CF | |
| 709330088002 | 8x80 | 20 | CF | |
| 709330810001 | 8x100 | 10 | CF | |
| 709330104002 | 10x40 | 20 | CF | |
| 709330105002 | 10x50 | 20 | CF | |
| 709330106002 | 10x60 | 20 | CF | |
| 709330108002 | 10x80 | 20 | CF | |
| 70933010001 | 10x100 | 10 | CF | |

Viti Testa Piana Svasata UNI 6109 DIN 963

Viti testa piana svasata UNI 6109 DIN 963 in Acciaio Inox A4.



| Cod. | mm | Pezzi / CF | UM | € |
|--------------|-------|------------|----|---|
| 709630032010 | 3x20 | 100 | CF | |
| 709630032510 | 3x25 | 100 | CF | |
| 709630033010 | 3x30 | 100 | CF | |
| 709630042010 | 4x20 | 100 | CF | |
| 709630042510 | 4x25 | 100 | CF | |
| 709630043010 | 4x30 | 100 | CF | |
| 709630044010 | 4x40 | 100 | CF | |
| 709630045010 | 4x50 | 100 | CF | |
| 709630052010 | 5x20 | 100 | CF | |
| 709630053010 | 5x30 | 100 | CF | |
| 709630054005 | 5x40 | 50 | CF | |
| 709630055005 | 5x50 | 50 | CF | |
| 709630056005 | 5x60 | 50 | CF | |
| 709630063005 | 6x30 | 50 | CF | |
| 709630064005 | 6x40 | 50 | CF | |
| 709630065005 | 6x50 | 50 | CF | |
| 709630066005 | 6x60 | 50 | CF | |
| 709630068002 | 6x80 | 20 | CF | |
| 709630610002 | 6x100 | 20 | CF | |
| 709630083005 | 8x30 | 50 | CF | |
| 709630084005 | 8x40 | 50 | CF | |
| 709630085005 | 8x50 | 50 | CF | |
| 709630086002 | 8x60 | 20 | CF | |
| 709630088002 | 8x80 | 20 | CF | |
| 709630810001 | 8x100 | 10 | CF | |

- VITI AUTOFILETTANTI -**Viti Testa Piana Svasata UNI 6955 DIN 7982**

Viti testa piana svasata in Acciaio Inox A4.



| Cod. | mm | Pezzi / CF | UM | € |
|--------------|--------|------------|----|---|
| 707982351310 | 3,5x13 | 100 | CF | |
| 707982351610 | 3,5x16 | 100 | CF | |
| 707982351910 | 3,5x19 | 100 | CF | |
| 707982352210 | 3,5x22 | 100 | CF | |
| 707982352510 | 3,5x25 | 100 | CF | |
| 707982391310 | 3,9x13 | 100 | CF | |
| 707982391610 | 3,9x16 | 100 | CF | |
| 707982391910 | 3,9x19 | 100 | CF | |
| 707982392210 | 3,9x22 | 100 | CF | |
| 707982392510 | 3,9x25 | 100 | CF | |
| 707982393210 | 3,9x32 | 100 | CF | |
| 707982393810 | 3,9x38 | 100 | CF | |
| 707982421610 | 4,2x16 | 100 | CF | |
| 707982421910 | 4,2x19 | 100 | CF | |
| 707982422210 | 4,2x22 | 100 | CF | |
| 707982422510 | 4,2x25 | 100 | CF | |
| 707982423210 | 4,2x32 | 100 | CF | |
| 707982423810 | 4,2x38 | 100 | CF | |
| 707982481610 | 4,8x16 | 100 | CF | |
| 707982481910 | 4,8x19 | 100 | CF | |
| 707982482210 | 4,8x22 | 100 | CF | |
| 707982482510 | 4,8x25 | 100 | CF | |
| 707982483210 | 4,8x32 | 100 | CF | |
| 707982483805 | 4,8x38 | 50 | CF | |
| 707982485005 | 4,8x50 | 50 | CF | |
| 707982552205 | 5,5x22 | 50 | CF | |
| 707982553205 | 5,5x32 | 50 | CF | |
| 707982553805 | 5,5x38 | 50 | CF | |
| 707982555005 | 5,5x50 | 50 | CF | |
| 707982632505 | 6,3x25 | 50 | CF | |
| 707982633205 | 6,3x32 | 50 | CF | |
| 707982633802 | 6,3x38 | 20 | CF | |
| 707982635002 | 6,3x50 | 20 | CF | |
| 707982636002 | 6,3x60 | 20 | CF | |

Viti Testa Cilindrica UNI 6954 DIN 7981

Viti testa cilindrica UNI 6954 DIN 7981 in Acciaio Inox A4.



| Cod. | mm | Pezzi / CF | UM | € |
|--------------|--------|------------|----|---|
| 707981351310 | 3,5x13 | 100 | CF | |
| 707981351610 | 3,5x16 | 100 | CF | |
| 707981351910 | 3,5x19 | 100 | CF | |
| 707981352210 | 3,5x22 | 100 | CF | |
| 707981352510 | 3,5x25 | 100 | CF | |
| 707981391310 | 3,9x13 | 100 | CF | |
| 707981391610 | 3,9x16 | 100 | CF | |
| 707981391910 | 3,9x19 | 100 | CF | |
| 707981392210 | 3,9x22 | 100 | CF | |
| 707981392510 | 3,9x25 | 100 | CF | |
| 707981393210 | 3,9x32 | 100 | CF | |
| 707981393810 | 3,9x38 | 100 | CF | |
| 707981421610 | 4,2x16 | 100 | CF | |
| 707981421910 | 4,2x19 | 100 | CF | |
| 707981422210 | 4,2x22 | 100 | CF | |
| 707981422510 | 4,2x25 | 100 | CF | |
| 707981423210 | 4,2x32 | 100 | CF | |
| 707981423810 | 4,2x38 | 100 | CF | |
| 707981481610 | 4,8x16 | 100 | CF | |
| 707981481910 | 4,8x19 | 100 | CF | |
| 707981482210 | 4,8x22 | 100 | CF | |
| 707981482510 | 4,8x25 | 100 | CF | |
| 707981483210 | 4,8x32 | 100 | CF | |
| 707981483805 | 4,8x38 | 50 | CF | |
| 707981485005 | 4,8x50 | 50 | CF | |
| 707981552205 | 5,5x22 | 50 | CF | |
| 707981553205 | 5,5x32 | 50 | CF | |
| 707981553805 | 5,5x38 | 50 | CF | |
| 707981555005 | 5,5x50 | 50 | CF | |
| 707981632505 | 6,3x25 | 50 | CF | |
| 707981633205 | 6,3x32 | 50 | CF | |
| 707981633802 | 6,3x38 | 20 | CF | |
| 707981635002 | 6,3x50 | 20 | CF | |
| 707981636002 | 6,3x60 | 20 | CF | |

- DADI E RONDELLE -**Dadi Esagonali UNI 5688 DIN 934**

Dadi esagonali in Acciaio Inox A4.



| Cod. | mm | Pezzi / CF | UM | € |
|--------------|-----|------------|----|---|
| 720093400410 | M4 | 100 | CF | |
| 720093400510 | M5 | 100 | CF | |
| 720093400610 | M6 | 100 | CF | |
| 720093400810 | M8 | 100 | CF | |
| 720093401005 | M10 | 50 | CF | |

Dadi Autobloccanti DIN 985

Dadi autobloccanti DIN 985 in Acciaio Inox A4.



| Cod. | mm | Pezzi / CF | UM | € |
|--------------|-----|------------|----|---|
| 720098500405 | M4 | 50 | CF | |
| 720098500505 | M5 | 50 | CF | |
| 720098500605 | M6 | 50 | CF | |
| 720098500805 | M8 | 50 | CF | |
| 720098501005 | M10 | 50 | CF | |

Rondelle Piane UNI 6592 DIN 125

Rondelle piane UNI 6592 DIN 125 in Acciaio Inox A4.



| Cod. | mm | Pezzi / CF | UM | € |
|--------------|------|------------|----|---|
| 725011250410 | D.4 | 100 | CF | |
| 725011250510 | D.5 | 100 | CF | |
| 725011250610 | D.6 | 100 | CF | |
| 725011250810 | D.8 | 100 | CF | |
| 725011251010 | D.10 | 100 | CF | |

Rondelle Piane 3 Volte il Foro

Rondelle piane 3 volte il foro in Acciaio Inox A4.



| Cod. | mm | Pezzi / CF | UM | € |
|--------------|-------|------------|----|---|
| 725000041210 | 4x12 | 100 | CF | |
| 725000051510 | 5x15 | 100 | CF | |
| 725000061810 | 6x18 | 100 | CF | |
| 725000082410 | 8x24 | 100 | CF | |
| 725000103005 | 10x30 | 50 | CF | |

Viti Testa Svasata Piana DIN 965 + DadiViti testa svasata piana in Acciaio Inox A4.
Confezione in Blister completa di dadi.

| Cod. | mm | Pezzi / CF | UM | € |
|-----------|------|------------|----|---|
| 796503010 | 3x10 | 10 | CF | |
| 796503016 | 3x16 | 10 | CF | |
| 796503020 | 3x20 | 8 | CF | |
| 796504012 | 4x12 | 8 | CF | |
| 796504016 | 4x16 | 8 | CF | |
| 796504020 | 4x20 | 8 | CF | |
| 796504025 | 4x25 | 6 | CF | |
| 796504030 | 4x30 | 6 | CF | |
| 796504040 | 4x40 | 6 | CF | |
| 796504050 | 4x50 | 6 | CF | |
| 796504060 | 4x60 | 4 | CF | |
| 796505016 | 5x16 | 6 | CF | |
| 796505020 | 5x20 | 6 | CF | |
| 796505025 | 5x25 | 6 | CF | |
| 796505030 | 5x30 | 6 | CF | |
| 796505040 | 5x40 | 6 | CF | |
| 796505050 | 5x50 | 4 | CF | |
| 796505060 | 5x60 | 4 | CF | |
| 796505070 | 5x70 | 4 | CF | |
| 796506016 | 6x16 | 4 | CF | |
| 796506020 | 6x20 | 4 | CF | |
| 796506025 | 6x25 | 4 | CF | |
| 796506030 | 6x30 | 4 | CF | |
| 796506040 | 6x40 | 4 | CF | |
| 796506050 | 6x50 | 4 | CF | |
| 796506060 | 6x60 | 4 | CF | |
| 796506070 | 6x70 | 4 | CF | |
| 796506080 | 6x80 | 2 | CF | |
| 796506090 | 6x90 | 2 | CF | |
| 796508020 | 8x20 | 4 | CF | |
| 796508030 | 8x30 | 4 | CF | |
| 796508040 | 8x40 | 4 | CF | |
| 796508050 | 8x50 | 2 | CF | |
| 796508060 | 8x60 | 2 | CF | |
| 796508070 | 8x70 | 2 | CF | |
| 796508080 | 8x80 | 2 | CF | |

Viti Testa Svasata con Calotta DIN 966 + DadiViti testa svasata con calotta in Acciaio Inox A4.
Confezione in Blister completa di dadi.

| Cod. | mm | Pezzi / CF | UM | € |
|-----------|------|------------|----|---|
| 796603010 | 3x10 | 10 | CF | |
| 796603016 | 3x16 | 10 | CF | |
| 796604016 | 4x16 | 6 | CF | |
| 796604020 | 4x20 | 6 | CF | |
| 796604030 | 4x30 | 6 | CF | |
| 796604040 | 4x40 | 6 | CF | |
| 796604050 | 4x50 | 6 | CF | |
| 796605016 | 5x16 | 6 | CF | |
| 796605020 | 5x20 | 6 | CF | |
| 796605025 | 5x25 | 6 | CF | |
| 796605030 | 5x30 | 6 | CF | |
| 796605040 | 5x40 | 6 | CF | |
| 796605050 | 5x50 | 4 | CF | |
| 796606020 | 6x20 | 4 | CF | |
| 796606030 | 6x30 | 4 | CF | |
| 796606035 | 6x35 | 4 | CF | |
| 796606040 | 6x40 | 4 | CF | |
| 796606050 | 6x50 | 4 | CF | |
| 796606060 | 6x60 | 4 | CF | |
| 796608060 | 8x60 | 2 | CF | |

Viti Testa Svasata Piana con Cava Esagonale ISO 10642 + Dadi

Viti testa svasata piana con cava esagonale ISO



10642 in Acciaio Inox A4.

Confezione in Blister completa di dadi.

| Cod. | mm | Pezzi / CF | UM | € |
|-----------|-------|------------|----|---|
| 793424416 | 4x16 | 8 | CF | |
| 793424420 | 4x20 | 8 | CF | |
| 793424430 | 4x30 | 6 | CF | |
| 793424440 | 4x40 | 6 | CF | |
| 793424450 | 4x50 | 4 | CF | |
| 793424516 | 5x16 | 6 | CF | |
| 793424520 | 5x20 | 6 | CF | |
| 793424530 | 5x30 | 6 | CF | |
| 793424540 | 5x40 | 4 | CF | |
| 793424550 | 5x50 | 4 | CF | |
| 793424560 | 5x60 | 4 | CF | |
| 793424620 | 6x20 | 4 | CF | |
| 793424630 | 6x30 | 4 | CF | |
| 793424640 | 6x40 | 4 | CF | |
| 793424650 | 6x50 | 4 | CF | |
| 793424660 | 6x60 | 4 | CF | |
| 793424680 | 6x80 | 2 | CF | |
| 793424820 | 8x20 | 4 | CF | |
| 793424830 | 8x30 | 4 | CF | |
| 793424840 | 8x40 | 4 | CF | |
| 793424850 | 8x50 | 2 | CF | |
| 793424860 | 8x60 | 2 | CF | |
| 793424880 | 8x80 | 2 | CF | |
| 793424810 | 8x100 | 2 | CF | |
| 793424120 | 10x20 | 2 | CF | |
| 793424140 | 10x40 | 2 | CF | |

Viti Testa Cilindrica DIN 7985 + DadiViti testa cilindrica DIN 7985 in Acciaio Inox A4.
Confezione in Blister completa di dadi.

| Cod. | mm | Pezzi / CF | UM | € |
|-----------|-------|------------|----|---|
| 798503010 | 3x10 | 10 | CF | |
| 798503016 | 3x16 | 10 | CF | |
| 798503020 | 3x20 | 8 | CF | |
| 798504016 | 4x16 | 8 | CF | |
| 798504020 | 4x20 | 8 | CF | |
| 798504025 | 4x25 | 6 | CF | |
| 798504030 | 4x30 | 6 | CF | |
| 798504040 | 4x40 | 6 | CF | |
| 798504050 | 4x50 | 6 | CF | |
| 798504060 | 4x60 | 6 | CF | |
| 798505020 | 5x20 | 6 | CF | |
| 798505030 | 5x30 | 6 | CF | |
| 798505040 | 5x40 | 6 | CF | |
| 798505050 | 5x50 | 4 | CF | |
| 798505060 | 5x60 | 4 | CF | |
| 798506020 | 6x20 | 4 | CF | |
| 798506025 | 6x25 | 4 | CF | |
| 798506030 | 6x30 | 4 | CF | |
| 798506040 | 6x40 | 4 | CF | |
| 798506050 | 6x50 | 4 | CF | |
| 798506060 | 6x60 | 4 | CF | |
| 798506080 | 6x80 | 4 | CF | |
| 798506100 | 6x100 | 3 | CF | |
| 798508035 | 8x35 | 4 | CF | |
| 798508040 | 8x40 | 4 | CF | |
| 798508060 | 8x60 | 2 | CF | |
| 798508070 | 8x70 | 2 | CF | |
| 798508080 | 8x80 | 2 | CF | |
| 798508100 | 8x100 | 2 | CF | |

Viti Testa Cilindrica con Cava Esagonale DIN 912 + Dadi

Viti testa cilindrica con cava esagonale in Acciaio Inox A4. Confezione in Blister completa di dadi.



| Cod. | mm | Pezzi / CF | UM | € |
|-----------|-------|------------|----|---|
| 791204012 | 4x12 | 8 | CF | |
| 791204016 | 4x16 | 8 | CF | |
| 791204020 | 4x20 | 8 | CF | |
| 791204025 | 4x25 | 6 | CF | |
| 791204030 | 4x30 | 6 | CF | |
| 791204040 | 4x40 | 6 | CF | |
| 791204050 | 4x50 | 6 | CF | |
| 791205012 | 5x12 | 6 | CF | |
| 791205016 | 5x16 | 6 | CF | |
| 791205020 | 5x20 | 6 | CF | |
| 791205025 | 5x25 | 6 | CF | |
| 791205030 | 5x30 | 6 | CF | |
| 791205040 | 5x40 | 6 | CF | |
| 791205050 | 5x50 | 4 | CF | |
| 791205060 | 5x60 | 4 | CF | |
| 791205060 | 5x60 | 4 | CF | |
| 791206016 | 6x16 | 4 | CF | |
| 791206020 | 6x20 | 4 | CF | |
| 791206025 | 6x25 | 4 | CF | |
| 791206030 | 6x30 | 4 | CF | |
| 791206040 | 6x40 | 4 | CF | |
| 791206050 | 6x50 | 4 | CF | |
| 791206060 | 6x60 | 4 | CF | |
| 791206080 | 6x80 | 2 | CF | |
| 791208020 | 8x20 | 4 | CF | |
| 791208025 | 8x25 | 4 | CF | |
| 791208030 | 8x30 | 4 | CF | |
| 791208040 | 8x40 | 4 | CF | |
| 791208050 | 8x50 | 2 | CF | |
| 791208060 | 8x60 | 2 | CF | |
| 791208080 | 8x80 | 2 | CF | |
| 791208100 | 8x100 | 2 | CF | |
| 791241030 | 10x30 | 4 | CF | |
| 791241040 | 10x40 | 3 | CF | |
| 791241050 | 10x50 | 3 | CF | |
| 791241060 | 10x60 | 2 | CF | |
| 791241080 | 10x80 | 2 | CF | |

Viti Testa Esagonale DIN 933 + Dadi

Viti testa esagonale DIN 933 in Acciaio Inox A4. Confezione in Blister completa di dadi.



| Cod. | mm | Pezzi / CF | UM | € |
|-----------|--------|------------|----|---|
| 793305010 | 5x10 | 8 | CF | |
| 793305016 | 5x16 | 8 | CF | |
| 793305020 | 5x20 | 8 | CF | |
| 793305025 | 5x25 | 6 | CF | |
| 793305030 | 5x30 | 6 | CF | |
| 793305040 | 5x40 | 6 | CF | |
| 793305050 | 5x50 | 4 | CF | |
| 793305060 | 5x60 | 4 | CF | |
| 793306020 | 6x20 | 6 | CF | |
| 793306025 | 6x25 | 6 | CF | |
| 793306030 | 6x30 | 4 | CF | |
| 793306040 | 6x40 | 4 | CF | |
| 793306050 | 6x50 | 4 | CF | |
| 793306060 | 6x60 | 4 | CF | |
| 793306070 | 6x70 | 3 | CF | |
| 793306080 | 6x80 | 3 | CF | |
| 793306100 | 6x100 | 2 | CF | |
| 793308020 | 8x20 | 4 | CF | |
| 793308030 | 8x30 | 4 | CF | |
| 793308040 | 8x40 | 4 | CF | |
| 793308050 | 8x50 | 2 | CF | |
| 793308060 | 8x60 | 2 | CF | |
| 793308070 | 8x70 | 2 | CF | |
| 793308080 | 8x80 | 2 | CF | |
| 793308100 | 8x100 | 2 | CF | |
| 793310020 | 10x20 | 2 | CF | |
| 793310025 | 10x25 | 2 | CF | |
| 793310030 | 10x30 | 2 | CF | |
| 793310040 | 10x40 | 2 | CF | |
| 793310050 | 10x50 | 2 | CF | |
| 793310060 | 10x60 | 2 | CF | |
| 793310080 | 10x80 | 2 | CF | |
| 793310100 | 10x100 | 2 | CF | |
| 793312100 | 12x100 | 2 | CF | |

- DADI E RONDELLE IN ACCIAIO INOX A4 -

Dadi Esagonali DIN 934

Dadi esagonali DIN 934 in Acciaio Inox A4. In comodi ed eleganti blister.



| Cod. | mm | Pezzi / CF | UM | € |
|---------|-----|------------|----|---|
| 7934003 | M3 | 20 | CF | |
| 7934004 | M4 | 20 | CF | |
| 7934005 | M5 | 15 | CF | |
| 7934006 | M6 | 15 | CF | |
| 7934008 | M8 | 10 | CF | |
| 7934010 | M10 | 6 | CF | |
| 7934012 | M12 | 4 | CF | |
| 7934014 | M14 | 2 | CF | |

Dadi Esagonali Autobloccanti DIN 985

Dadi esagonali autobloccanti DIN 985 in Acciaio Inox A4. In comodi ed eleganti blister.



| Cod. | mm | Pezzi / CF | UM | € |
|---------|-----|------------|----|---|
| 7985003 | M3 | 20 | CF | |
| 7985004 | M4 | 20 | CF | |
| 7985005 | M5 | 12 | CF | |
| 7985006 | M6 | 12 | CF | |
| 7985008 | M8 | 10 | CF | |
| 7985010 | M10 | 4 | CF | |
| 7985012 | M12 | 3 | CF | |

Dadi Esagonali Autobloccanti Flangiati DIN 6926

Dadi esagonali autobloccanti flangiati DIN 6926 in Acciaio Inox A4. In comodi ed eleganti blister.



| Cod. | mm | Pezzi / CF | UM | € |
|---------|-----|------------|----|---|
| 7692604 | M4 | 10 | CF | |
| 7692605 | M5 | 10 | CF | |
| 7692606 | M6 | 8 | CF | |
| 7692608 | M8 | 6 | CF | |
| 7692610 | M10 | 3 | CF | |
| 7692612 | M12 | 2 | CF | |

Dadi Ciechi a Calotta DIN 1587

Dadi ciechi a calotta DIN 1587 in Acciaio Inox A4. In comodi ed eleganti blister.



| Cod. | mm | Pezzi / CF | UM | € |
|---------|-----|------------|----|---|
| 7158703 | M3 | 6 | CF | |
| 7158704 | M4 | 6 | CF | |
| 7158705 | M5 | 6 | CF | |
| 7158706 | M6 | 4 | CF | |
| 7158708 | M8 | 4 | CF | |
| 7158710 | M10 | 2 | CF | |
| 7158712 | M12 | 2 | CF | |

Dadi ad Alette DIN 315

Dadi ad alette DIN 315 in Acciaio Inox A4. In comodi ed eleganti blister.

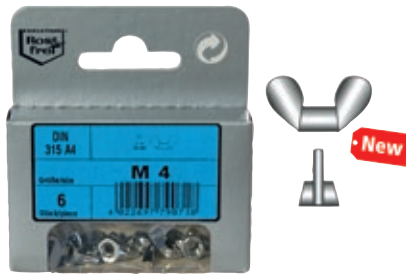

| Cod. | mm | Pezzi / CF | UM | € |
|---------|-----|------------|----|---|
| 7931504 | M4 | 6 | CF | |
| 7931505 | M5 | 6 | CF | |
| 7931506 | M6 | 4 | CF | |
| 7931508 | M8 | 4 | CF | |
| 7931510 | M10 | 2 | CF | |
| 7931512 | M12 | 2 | CF | |

Dadi a Calotta Filetto Interno

Dadi a calotta con filettatura interna metrica in Acciaio Inox A4. In comodi ed eleganti blister.



| Cod. | mm | Pezzi / CF | UM | € |
|---------|----|------------|----|---|
| 7910424 | M4 | 4 | CF | |
| 7910425 | M5 | 4 | CF | |
| 7910426 | M6 | 3 | CF | |
| 7910428 | M8 | 2 | CF | |

Rondelle Elastiche Grower DIN 127

Rondelle elastiche Grower DIN 127 in Acciaio Inox A4. In comodi ed eleganti blister.



| Cod. | mm | Pezzi / CF | UM | € |
|---------|--------|------------|----|---|
| 7127043 | D.3,1 | 30 | CF | |
| 7127044 | D.4,1 | 30 | CF | |
| 7127045 | D.5,1 | 30 | CF | |
| 7127046 | D.6,1 | 30 | CF | |
| 7127048 | D.8,1 | 20 | CF | |
| 7127010 | D.10,2 | 20 | CF | |
| 7127012 | D.12,2 | 20 | CF | |
| 7127014 | D.14,3 | 6 | CF | |
| 7127016 | D.16,3 | 6 | CF | |

Rondelle Piane DIN 125

Rondelle piane DIN 125 in Acciaio Inox A4. In comodi ed eleganti blister.



| Cod. | mm | Pezzi / CF | UM | € |
|---------|--------|------------|----|---|
| 7125003 | D.3,2 | 30 | CF | |
| 7125004 | D.4,3 | 30 | CF | |
| 7125005 | D.5,3 | 30 | CF | |
| 7125006 | D.6,4 | 30 | CF | |
| 7125008 | D.8,4 | 20 | CF | |
| 7125010 | D.10,5 | 10 | CF | |
| 7125013 | D.13,0 | 10 | CF | |
| 7125015 | D.15,0 | 6 | CF | |
| 7125017 | D.17,0 | 6 | CF | |

Rondelle Piane 3 Volte il Foro DIN 9021

Rondelle piane 3 volte il foro DIN 9021 in Acciaio Inox A4. In comodi ed eleganti blister.



| Cod. | mm | Pezzi / CF | UM | € |
|---------|-----------|------------|----|---|
| 7902103 | 3,2 x 9 | 20 | CF | |
| 7902104 | 4,3 x 12 | 20 | CF | |
| 7902105 | 5,3 x 15 | 20 | CF | |
| 7902106 | 6,4 x 18 | 20 | CF | |
| 7902108 | 8,4 x 24 | 10 | CF | |
| 7902110 | 10,5 x 30 | 6 | CF | |
| 7902113 | 13,0 x 37 | 4 | CF | |

Rondelle Coniche (Rosette)

Rondelle coniche (rosette) in Acciaio Inox A4. In comodi ed eleganti blister.



| Cod. | mm | Pezzi / CF | UM | € |
|---------|--------|------------|----|---|
| 7101103 | D.3,5 | 10 | CF | |
| 7101104 | D.4,3 | 10 | CF | |
| 7101105 | D.5,3 | 8 | CF | |
| 7101106 | D.6,4 | 6 | CF | |
| 7101108 | D.8,5 | 4 | CF | |
| 7101111 | D.11,0 | 4 | CF | |

Viti Autofilettanti Testa Cilindrica DIN 7981

Viti autofilettanti testa cilindrica DIN 7981 in Acciaio Inox A4.

In comodi ed eleganti blister.



| Cod. | mm | Pezzi / CF | UM | € |
|-----------|---------|------------|----|---|
| 798129009 | 2,9x9,5 | 20 | CF | |
| 798129013 | 2,9x13 | 20 | CF | |
| 798129016 | 2,9x16 | 20 | CF | |
| 798129019 | 2,9x19 | 20 | CF | |
| 798129025 | 2,9x25 | 20 | CF | |
| 798129032 | 2,9x32 | 20 | CF | |
| 798135095 | 3,5x9,5 | 20 | CF | |
| 798135013 | 3,5x13 | 20 | CF | |
| 798135016 | 3,5x16 | 20 | CF | |
| 798135019 | 3,5x19 | 20 | CF | |
| 798135022 | 3,5x22 | 15 | CF | |
| 798135025 | 3,5x25 | 15 | CF | |
| 798135032 | 3,5x32 | 15 | CF | |
| 798135038 | 3,5x38 | 15 | CF | |
| 798139013 | 3,9x13 | 20 | CF | |
| 798139016 | 3,9x16 | 20 | CF | |
| 798139019 | 3,9x19 | 20 | CF | |
| 798139025 | 3,9x25 | 15 | CF | |
| 798139032 | 3,9x32 | 15 | CF | |
| 798139038 | 3,9x38 | 15 | CF | |
| 798142013 | 4,2x13 | 20 | CF | |
| 798142016 | 4,2x16 | 20 | CF | |
| 798142019 | 4,2x19 | 20 | CF | |
| 798142022 | 4,2x22 | 15 | CF | |
| 798142025 | 4,2x25 | 15 | CF | |
| 798142032 | 4,2x32 | 15 | CF | |
| 798142038 | 4,2x38 | 12 | CF | |
| 798142045 | 4,2x45 | 10 | CF | |
| 798142050 | 4,2x50 | 10 | CF | |
| 798142060 | 4,2x60 | 8 | CF | |
| 798148013 | 4,8x13 | 20 | CF | |
| 798148016 | 4,8x16 | 20 | CF | |
| 798148019 | 4,8x19 | 15 | CF | |
| 798148022 | 4,8x22 | 15 | CF | |
| 798148025 | 4,8x25 | 10 | CF | |
| 798148032 | 4,8x32 | 10 | CF | |
| 798148038 | 4,8x38 | 8 | CF | |
| 798148045 | 4,8x45 | 8 | CF | |
| 798148050 | 4,8x50 | 8 | CF | |
| 798148060 | 4,8x60 | 8 | CF | |
| 798155016 | 5,5x16 | 10 | CF | |
| 798155019 | 5,5x19 | 10 | CF | |
| 798155025 | 5,5x25 | 10 | CF | |
| 798155032 | 5,5x32 | 8 | CF | |
| 798155038 | 5,5x38 | 8 | CF | |
| 798155045 | 5,5x45 | 8 | CF | |
| 798155050 | 5,5x50 | 6 | CF | |
| 798155060 | 5,5x60 | 6 | CF | |
| 798163019 | 6,3x19 | 6 | CF | |
| 798163025 | 6,3x25 | 6 | CF | |
| 798163032 | 6,3x32 | 6 | CF | |
| 798163038 | 6,3x38 | 6 | CF | |
| 798163050 | 6,3x50 | 6 | CF | |

Viti Autofilettanti Testa Svasata Piana DIN 7982

Viti autofilettanti testa svasata piana in Acciaio Inox A4. In comodi ed eleganti blister.



| Cod. | mm | Pezzi / CF | UM | € |
|-----------|---------|------------|----|---|
| 798229009 | 2,9x9,5 | 20 | CF | |
| 798229013 | 2,9x13 | 20 | CF | |
| 798229016 | 2,9x16 | 20 | CF | |
| 798229019 | 2,9x19 | 20 | CF | |
| 798229025 | 2,9x25 | 20 | CF | |
| 798229032 | 2,9x32 | 20 | CF | |
| 798235095 | 3,5x3,9 | 20 | CF | |
| 798235013 | 3,5x13 | 20 | CF | |
| 798235016 | 3,5x16 | 20 | CF | |
| 798235019 | 3,5x19 | 20 | CF | |
| 798235025 | 3,5x25 | 15 | CF | |
| 798235032 | 3,5x32 | 15 | CF | |
| 798235038 | 3,5x38 | 15 | CF | |
| 798239013 | 3,9x13 | 20 | CF | |
| 798239019 | 3,9x19 | 20 | CF | |
| 798239025 | 3,9x25 | 15 | CF | |
| 798239032 | 3,9x32 | 15 | CF | |
| 798239038 | 3,9x38 | 15 | CF | |
| 798242013 | 4,2x13 | 20 | CF | |
| 798242016 | 4,2x16 | 20 | CF | |
| 798242019 | 4,2x19 | 20 | CF | |
| 798242025 | 4,2x25 | 15 | CF | |
| 798242032 | 4,2x32 | 15 | CF | |
| 798242038 | 4,2x38 | 12 | CF | |
| 798242045 | 4,2x45 | 10 | CF | |
| 798242050 | 4,2x50 | 10 | CF | |
| 798242060 | 4,2x60 | 8 | CF | |
| 798248013 | 4,8x13 | 20 | CF | |
| 798248016 | 4,8x16 | 20 | CF | |
| 798248019 | 4,8x19 | 15 | CF | |
| 798248025 | 4,8x25 | 10 | CF | |
| 798248032 | 4,8x32 | 10 | CF | |
| 798248038 | 4,8x38 | 8 | CF | |
| 798248045 | 4,8x45 | 8 | CF | |
| 798248050 | 4,8x50 | 8 | CF | |
| 798248060 | 4,8x60 | 8 | CF | |
| 798248070 | 4,8x70 | 6 | CF | |
| 798255016 | 5,5x16 | 10 | CF | |
| 798255019 | 5,5x19 | 10 | CF | |
| 798255025 | 5,5x25 | 10 | CF | |
| 798255032 | 5,5x32 | 8 | CF | |
| 798255038 | 5,5x38 | 8 | CF | |
| 798255045 | 5,5x45 | 8 | CF | |
| 798255050 | 5,5x50 | 6 | CF | |
| 798255060 | 5,5x60 | 6 | CF | |
| 798263025 | 6,3x25 | 6 | CF | |
| 798263032 | 6,3x32 | 6 | CF | |
| 798263038 | 6,3x38 | 6 | CF | |
| 798263050 | 6,3x50 | 6 | CF | |
| 798263060 | 6,3x60 | 6 | CF | |

Viti Autofilettanti Testa Svasata con Calotta DIN 7983

Viti autofilettanti testa svasata con calotta DIN 7983 in Acciaio Inox A4. In comodi ed eleganti blister.



| Cod. | mm | Pezzi / CF | UM | € |
|-----------|---------|------------|----|---|
| 798329009 | 2,9x9,5 | 20 | CF | |
| 798329013 | 2,9x13 | 20 | CF | |
| 798329016 | 2,9x16 | 20 | CF | |
| 798329019 | 2,9x19 | 20 | CF | |
| 798329022 | 2,9x22 | 20 | CF | |
| 798329025 | 2,9x25 | 20 | CF | |
| 798335095 | 3,5x9,5 | 20 | CF | |
| 798335013 | 3,5x13 | 20 | CF | |
| 798335016 | 3,5x16 | 20 | CF | |
| 798335019 | 3,5x19 | 20 | CF | |
| 798335025 | 3,5x25 | 15 | CF | |
| 798335032 | 3,5x32 | 15 | CF | |
| 798335038 | 3,5x38 | 15 | CF | |
| 798339013 | 3,9x13 | 20 | CF | |
| 798339016 | 3,9x16 | 20 | CF | |
| 798339019 | 3,9x19 | 20 | CF | |
| 798339025 | 3,9x25 | 15 | CF | |
| 798342013 | 4,2x13 | 20 | CF | |
| 798342016 | 4,2x16 | 20 | CF | |
| 798342019 | 4,2x19 | 20 | CF | |
| 798342022 | 4,2x22 | 15 | CF | |
| 798342025 | 4,2x25 | 15 | CF | |
| 798342032 | 4,2x32 | 15 | CF | |
| 798342038 | 4,2x38 | 12 | CF | |
| 798342045 | 4,2x45 | 10 | CF | |
| 798342050 | 4,2x50 | 10 | CF | |
| 798342060 | 4,2x60 | 8 | CF | |
| 798348013 | 4,8x13 | 20 | CF | |
| 798348016 | 4,8x16 | 20 | CF | |
| 798348019 | 4,8x19 | 15 | CF | |
| 798348025 | 4,8x25 | 10 | CF | |
| 798348032 | 4,8x32 | 10 | CF | |
| 798348038 | 4,8x38 | 8 | CF | |
| 798348045 | 4,8x45 | 8 | CF | |
| 798348050 | 4,8x50 | 8 | CF | |
| 798348060 | 4,8x60 | 8 | CF | |
| 798355016 | 5,5x16 | 10 | CF | |
| 798355019 | 5,5x19 | 10 | CF | |
| 798355025 | 5,5x25 | 10 | CF | |
| 798355032 | 5,5x32 | 8 | CF | |
| 798355038 | 5,5x38 | 8 | CF | |
| 798355045 | 5,5x45 | 8 | CF | |
| 798355050 | 5,5x50 | 6 | CF | |
| 798355060 | 5,5x60 | 6 | CF | |
| 798355070 | 5,5x70 | 4 | CF | |
| 798363019 | 6,3x19 | 6 | CF | |
| 798363025 | 6,3x25 | 6 | CF | |
| 798363038 | 6,3x38 | 6 | CF | |
| 798363050 | 6,3x50 | 6 | CF | |
| 798363060 | 6,3x60 | 6 | CF | |
| 798363080 | 6,3x80 | 4 | CF | |

Viti Legno Testa Svasata Piana DIN 97 Inox

Viti legno testa svasata piana DIN 97 in Acciaio Inox A4. In comodi ed eleganti blister.



| Cod. | mm | Pezzi / CF | UM | € |
|---------|------|------------|----|---|
| 7973012 | 3x12 | 20 | CF | |
| 7973016 | 3x16 | 20 | CF | |
| 7973020 | 3x20 | 20 | CF | |
| 7973025 | 3x25 | 15 | CF | |
| 7973030 | 3x30 | 12 | CF | |
| 7974020 | 4x20 | 15 | CF | |
| 7974030 | 4x30 | 15 | CF | |
| 7974040 | 4x40 | 10 | CF | |
| 7974050 | 4x50 | 8 | CF | |
| 7975030 | 5x30 | 10 | CF | |
| 7975040 | 5x40 | 8 | CF | |
| 7975050 | 5x50 | 6 | CF | |
| 7975060 | 5x60 | 6 | CF | |
| 7976030 | 6x30 | 4 | CF | |
| 7976060 | 6x60 | 4 | CF | |
| 7976070 | 6x70 | 2 | CF | |

Viti Metriche Legno Testa a Fungo DIN 603 Inox

Viti metriche legno testa a fungo e innesto quadro DIN 603 in Acciaio Inox A4. In comodi ed eleganti blister. Confezione completa di dadi.



| Cod. | mm | Pezzi / CF | UM | € |
|-----------|-------|------------|----|---|
| 796030630 | M6x30 | 4 | CF | |
| 796030640 | M6x40 | 4 | CF | |
| 796030650 | M6x50 | 4 | CF | |
| 796030660 | M6x60 | 2 | CF | |
| 796030840 | M8x40 | 2 | CF | |
| 796030860 | M8x60 | 2 | CF | |
| 796030880 | M8x80 | 2 | CF | |

Viti per Pannelli Truciolari Testa Svasata Piana DIN 6112 Inox

Viti per pannelli truciolari testa svasata piana DIN 6112 in Acciaio Inox A4. In comodi ed eleganti blister.



| Cod. | mm | Pezzi / CF | UM | € |
|-----------|-----------|------------|----|---|
| 761123016 | 3x16 | 20 | CF | |
| 761123020 | 3x20 | 15 | CF | |
| 761123025 | 3x25 | 12 | CF | |
| 761123030 | 3x30 | 10 | CF | |
| 761123040 | 3x40 | 10 | CF | |
| 761123516 | 3,5x16 | 15 | CF | |
| 761123520 | 3,5x20 | 12 | CF | |
| 761123530 | 3,5x30 | 10 | CF | |
| 761123540 | 3,5x40 | 10 | CF | |
| 761124016 | 4x16 | 12 | CF | |
| 761124020 | 4x20 | 12 | CF | |
| 761124025 | 4x25 | 12 | CF | |
| 761124030 | 4x30 | 10 | CF | |
| 761124035 | 4x35 | 8 | CF | |
| 761124040 | 4x40 | 8 | CF | |
| 761124050 | 4x50 | 8 | CF | |
| 761124060 | 4x60 | 6 | CF | |
| 761124530 | 4,5x30/18 | 10 | CF | |
| 761124540 | 4,5x40 | 10 | CF | |
| 761124550 | 4,5x50 | 10 | CF | |
| 761125020 | 5x20 | 10 | CF | |
| 761125030 | 5x30 | 10 | CF | |
| 761125040 | 5x40 | 8 | CF | |
| 761125050 | 5x50 | 8 | CF | |
| 761125060 | 5x60 | 6 | CF | |
| 761125070 | 5x70 | 4 | CF | |
| 761125080 | 5x80 | 4 | CF | |
| 761126030 | 6x30 | 8 | CF | |
| 761126040 | 6x40 | 6 | CF | |
| 761126050 | 6x50 | 4 | CF | |
| 761126060 | 6x60 | 4 | CF | |
| 761126080 | 6x80 | 4 | CF | |

Viti Legno Testa Piana Svasata in Bronzo DIN 97

Viti legno testa piana svasata DIN 97 in Bronzo. In comodi ed eleganti blister.



| Cod. | mm | Pezzi / CF | UM | € |
|---------|------|------------|----|---|
| 7609702 | 3x20 | 10 | CF | |
| 7609704 | 4x40 | 8 | CF | |
| 7609705 | 5x50 | 6 | CF | |
| 7609706 | 6x60 | 4 | CF | |

Viti Legno Testa Esagonale DIN 571 Inox

Viti legno testa esagonale DIN 571 in Acciaio Inox A4. In comodi ed eleganti blister.



| Cod. | mm | Pezzi / CF | UM | € |
|----------|-------|------------|----|---|
| 75716030 | 6x30 | 4 | CF | |
| 75716040 | 6x40 | 4 | CF | |
| 75716050 | 6x50 | 4 | CF | |
| 75716060 | 6x60 | 4 | CF | |
| 75716070 | 6x70 | 2 | CF | |
| 75716080 | 6x80 | 2 | CF | |
| 75716100 | 6x100 | 2 | CF | |
| 75718030 | 8x30 | 4 | CF | |
| 75718040 | 8x40 | 4 | CF | |
| 75718050 | 8x50 | 2 | CF | |
| 75718060 | 8x60 | 2 | CF | |
| 75718070 | 8x70 | 2 | CF | |
| 75718080 | 8x80 | 2 | CF | |
| 75718100 | 8x100 | 2 | CF | |

Viti Legno Per Pavimenti con Impronta TX Inox

Viti legno per pavimenti con impronta TX (Torx) in Acciaio Inox A4. In comodi ed eleganti blister.



| Cod. | mm | Pezzi / CF | UM | € |
|---------|--------|------------|----|---|
| 7610116 | 4,2x16 | 15 | CF | |
| 7610119 | 4,8x19 | 15 | CF | |

Chiodini in Rame per Legno

Chiodini in rame per legno. In comodi ed eleganti blister.



| Cod. | mm | Pezzi / CF | UM | € |
|---------|--------|------------|----|---|
| 7630125 | 2x25 | 30 | CF | |
| 7630132 | 2,7x32 | 20 | CF | |
| 7630138 | 3,2x38 | 10 | CF | |
| 7630170 | 4x70 | 6 | CF | |

FERRAMENTA/CHIUSURE/VITERIA

2

Rivetti a Strappo in Acciaio Inox A4Rivetti a strappo in Acciaio Inox A4 (AISI 316).
In comodi ed eleganti blister.**New**

| Cod. | mm | Pezzi / CF | UM | € |
|-----------|----------|------------|----|---|
| 710143012 | 3,0 x 12 | 6 | CF | |
| 710144016 | 4,0 x 16 | 6 | CF | |
| 710144018 | 4,0 x 18 | 6 | CF | |
| 710145020 | 5,0 x 20 | 4 | CF | |
| 710145025 | 5,0 x 25 | 4 | CF | |

Rivetti a Strappo in Lega Monel DIN 7337Rivetti a strappo DIN 7337 in lega Monel indicati
per lavori su leghe di alluminio. In comodi ed
eleganti blister.**New**

| Cod. | mm | Pezzi / CF | UM | € |
|-----------|------------|------------|----|---|
| 773373010 | 3,2 x 10,5 | 6 | CF | |
| 773374076 | 4,0 x 7,6 | 6 | CF | |
| 773374010 | 4,0 x 10,2 | 6 | CF | |
| 773374011 | 4,0 x 11,4 | 6 | CF | |
| 773374809 | 4,8 x 9,8 | 4 | CF | |
| 773374812 | 4,8 x 12,7 | 4 | CF | |
| 773374816 | 4,8 x 16,5 | 4 | CF | |
| 773374819 | 4,8 x 19,0 | 4 | CF | |

Copiglie DIN 94 Inox A4Copiglie DIN 94 in Acciaio Inox A4.
In comodi ed eleganti blister.**New**

| Cod. | mm | Pezzi / CF | UM | € |
|---------|--------|------------|----|---|
| 7942516 | 2,5x16 | 10 | CF | |
| 7942520 | 2,5x20 | 10 | CF | |
| 7942525 | 2,5x25 | 10 | CF | |
| 7942532 | 2,5x32 | 10 | CF | |
| 7943216 | 3,2x16 | 10 | CF | |
| 7943220 | 3,2x20 | 10 | CF | |
| 7943225 | 3,2x25 | 8 | CF | |
| 7943232 | 3,2x32 | 8 | CF | |
| 7943240 | 3,2x40 | 8 | CF | |
| 7943245 | 3,2x45 | 8 | CF | |
| 7944020 | 4x20 | 8 | CF | |
| 7944025 | 4x25 | 8 | CF | |
| 7944032 | 4x32 | 6 | CF | |
| 7944040 | 4x40 | 5 | CF | |
| 7944045 | 4x45 | 5 | CF | |
| 7944050 | 4x50 | 4 | CF | |
| 7945032 | 5x32 | 6 | CF | |
| 7945045 | 5x45 | 6 | CF | |
| 7945050 | 5x50 | 5 | CF | |

Rondelle di Sicurezza (Seeger) Inox A2Rondelle di sicurezza (seeger) in Acciaio Inox A2.
In comodi ed eleganti blister.**New**

| Cod. | mm | Pezzi / CF | UM | € |
|---------|--------|------------|----|---|
| 7167991 | D.3,2 | 20 | CF | |
| 7167992 | D.4,0 | 20 | CF | |
| 7167993 | D.5,0 | 20 | CF | |
| 7167994 | D.6,0 | 20 | CF | |
| 7167995 | D.8,0 | 15 | CF | |
| 7167996 | D.10,0 | 10 | CF | |

Anellini di Sicurezza Inox A4 (Ringpin) Inox A4Anellini di sicurezza in Acciaio Inox A4.
In comodi ed eleganti blister.**New**

| Cod. | mm | Pezzi / CF | UM | € |
|-----------|----------|------------|----|---|
| 783831010 | 1,0 x 10 | 20 | CF | |
| 783831215 | 1,2 x 15 | 20 | CF | |
| 783831520 | 1,5 x 20 | 10 | CF | |
| 783831825 | 1,8 x 25 | 10 | CF | |